

Model 301B Mono-Block Ceramic Pressure Sensors



Description

The 301B is piezoresistive pressure sensor based on ceramics. By means of thick film technology, the bridge circuit is directly printed at the back of a ceramic pressure diaphragm. Thanks to excellent corrosion resistance, the other side of the diaphragm can be exposed to measured media without any additional protection. And this sensor is widely used in HVAC applications.

As the 301B is made from one piece of Al₂O₃ ceramics (mono-block structure), it possesses a rigid structure and can be mounted directly in a case by using an O-ring or to a metal fitting.

The sensor has the standard diameter of 18mm and are temperature compensated. There are also various options of output signal available on request.



Features

- excellent corrosion resistance
- various output options: 2mV/V, 10%~90%Vc ratiometric, I²C, SPI, ZACwire
- pressure ranges: 4bar, ..., 400bar
- excellent resistance to shock and vibration
- easy mounting

Applications

- automotive industry
- HVAC systems
- liquid level control
- process control systems
- pneumatic and hydraulic controls
- biomedical instrumentation

Dimensions

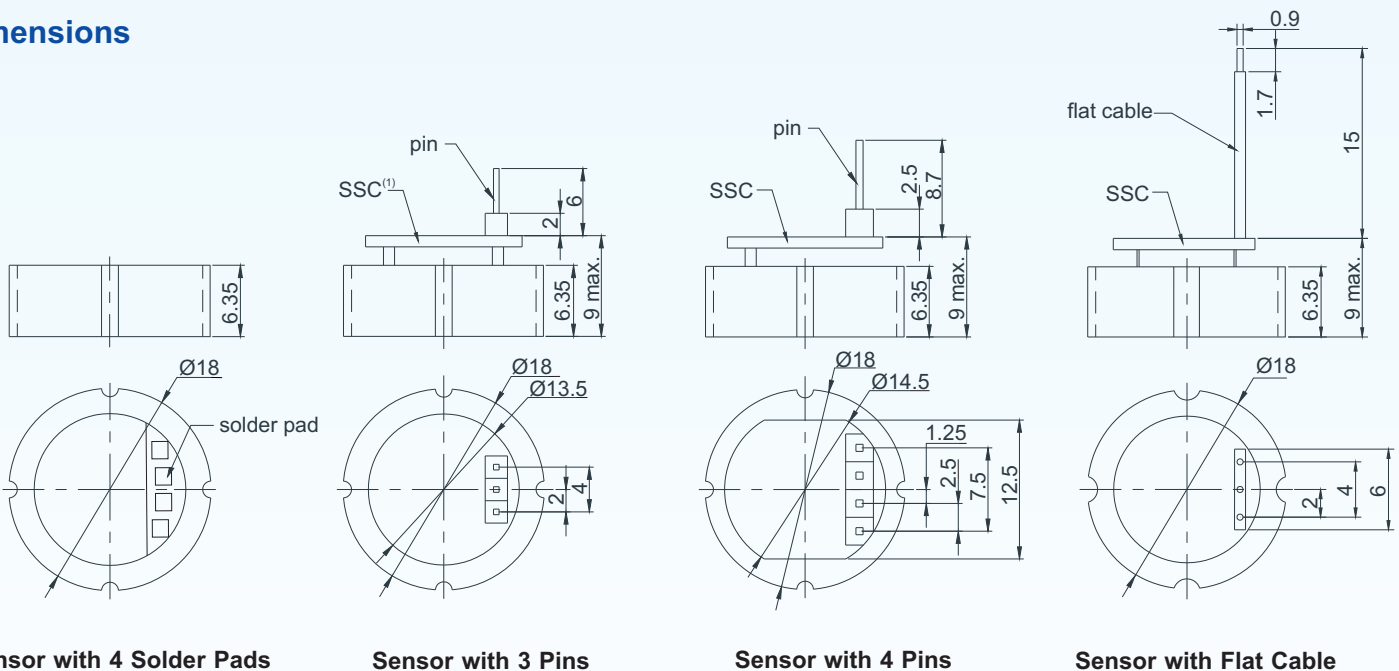

Sensor with 4 Solder Pads

Sensor with 3 Pins

Sensor with 4 Pins

Sensor with Flat Cable

Notes: (1) "SSC" refers to the sensor signal conditioner.

(2) All dimensions are in mm.

BCM SENSOR TECHNOLOGIES BVBA

Model 301B Mono-Block Ceramic Pressure Sensors



Technical Data

Parameters	Units	Specifications	Notes
model		301B	
pressure medium		compatible with pressure diaphragm	
measuring ranges	bar	0~4, ~5, ~10, ~16, ~20, ~25, ~30, ~40, ~50, ~100, ~160, ~200, ~250, ~300, ~400	1
pressure references		gauge	
proof pressure	%fs	200	2
burst pressure	%fs	400	
output sensitivity (standard)	mV/V	≥ 2	3
conditioned-signal output (option)		10%~90%Vs ratiometric, I ² C, SPI, ZACwire	4
excitation for mV output	Vdc	3, ..., 15	
power supply (Vs) for conditioned output	Vdc	3, ..., 5	
load resistance for voltage output	kΩ	> 5	
zero offset	mV	≤ ±0.5	
accuracy	%fs	±0.5	5
long-term stability	%fs/year	≤ ±0.3	
bridge resistance	kΩ	11 ±20%	
insulation resistance	MΩ	≥ 200 @50Vdc	
compensated temperature range	°C	0 ~ 70	
operating temperature range	°C	-40 ~ +135	
storage temperature range	°C	-40 ~ +135	
temperature coefficient of zero offset	%fso/°C	≤ ±0.03	6
temperature coefficient of span	%fso/°C	≤ -0.01	6
life time	cycles	10 ⁸	
response time	ms	≤ 1	7
electrical interface		4 solder pads (standard and only for mV output)	
		3 or 4 colored PVC flying wires, length = 100mm	8
		3 or 4 pins	8
		3-conductor flat cable, 15mm (only for conditioned-signal output)	8
pressure diaphragm		ceramic (96% Al ₂ O ₃)	
net weight	gram	~3	

General conditions for measurements: media temp. = 25°C ±1°C, ambient temp. = 25°C ±1°C.

Notes: 1. For customized pressure ranges, consult BCM.

2. "fs" means full scale and refers to the maximum working pressure or rated pressure.
3. Measured at full scale pressure.
4. A PCB board will be attached to the sensor.
5. Accuracy = $\sqrt{\text{non-linearity}^2 + \text{hysteresis}^2 + \text{repeatability}^2}$.
6. Calculated as a rate of output change between 0°C and 70°C, and normalized by the output at 25°C.
7. Response time for a 0 bar to fs step change, 10% to 90% rise time of leading edge.
8. 4 contacts for millivolt output and for I²C and SPI output; 3 contacts for ratiometric and ZACwire output.

BCM SENSOR TECHNOLOGIES BVBA

Model 301B Mono-Block Ceramic Pressure Sensors

Electrical Interface

Solder Pads (SP)

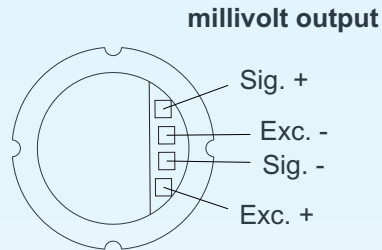
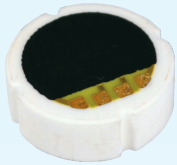

Flying Wires (FW)

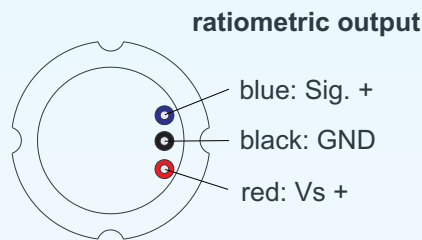
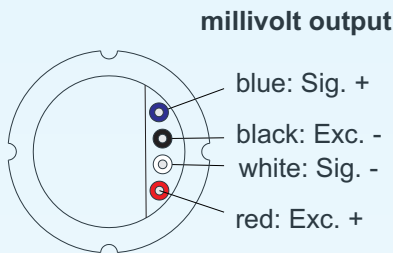

Pins (PI)

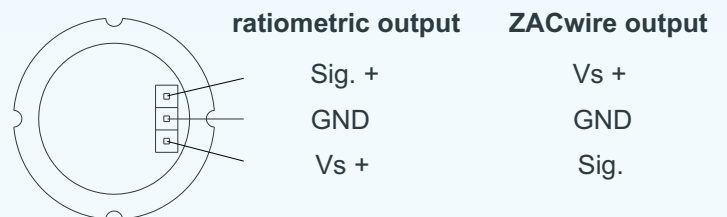
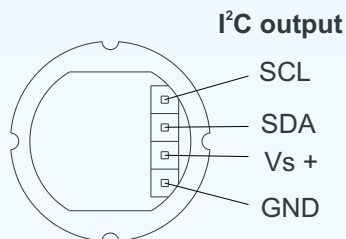
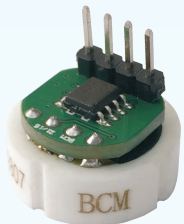

Flat Cable (FC)

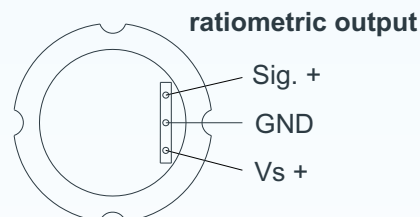
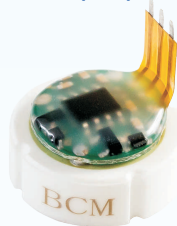

Model 301B Mono-Block Ceramic Pressure Sensors



Ordering Information

position (pos.) 1: model					
301B					
pos. 2: pressure ranges and references					
4bar	G	25bar	G	160bar	G
5bar	G	30bar	G	200bar	G
10bar	G	40bar	G	250bar	G
16bar	G	50bar	G	300bar	G
20bar	G	100bar	G	400bar	G
G: gauge pressure					
Note: In case of the conditioned output signal, indicate both min. and max. measuring pressure, e.g., 0/10bar.					
pos. 3: output signal					
2mV/V (standard)					
10%/90%Vs = 10%~90%Vs ratiometric I ² C SPI ZACwire					
pos. 4: temperature compensation					
T1 = 0~70 °C					
pos. 5: electrical interface					
SP: 4 solder pads (standard and only for mV output)					
FW: 3 or 4 (#) colored PVC flying wires, length = 100mm(##)					
PI: 3 or 4 (#) pins					
FC: 3-conductor flat cable, length = 15mm (only for ratiometric output)					
#: The specific number of conductor refers to note 8 of Technical Data.					
##: Wire length can be customized on request.					
pos. 6: customized specifications					
“(*)” is necessary only if any customized parameter is required, otherwise it is neglectable.					
pos.1	pos. 2	pos. 3	pos. 4	pos. 5	pos. 6

Examples of Ordering Code

- standard sensor:

301B-25barG-2mV/V-T1-SP

- customized sensor:

301B-0/50barG-10%/90%Vs-T1-FW(200mm)-(*)

(*): Customized flying wire length = 200mm.

The listed dimensions, specifications, and ordering information are subject to change without prior notice.

BCM SENSOR TECHNOLOGIES BVBA

