

Pilot Operated Check Valve, size 2 Stack Mounting Series SREA ..

R - 15.00

Issue 08-97

with ISO 4401-02-01 interface

- Check valve with guided poppet
- All moving parts hardened
- 2 cracking pressures available

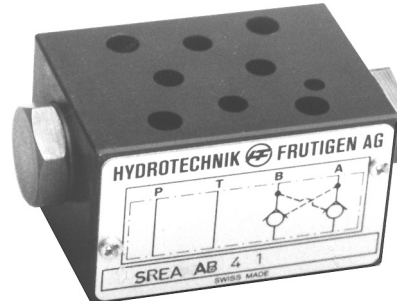

4 mm nom.
p max. 250 [bar]
Q max. 25 [l/min]

DIMENSIONS

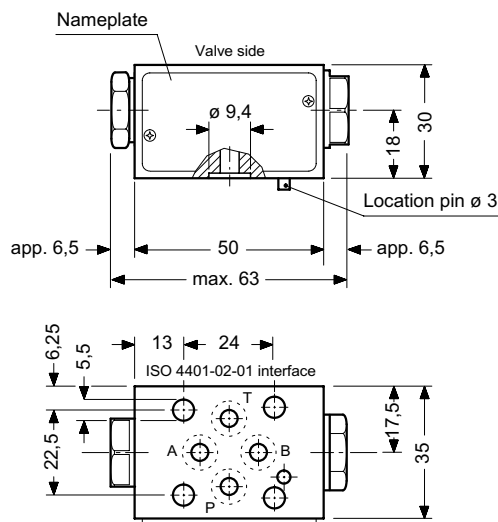

How to recognise
check valve & blanking plug

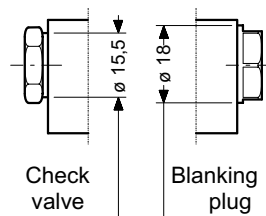

SYMBOLS

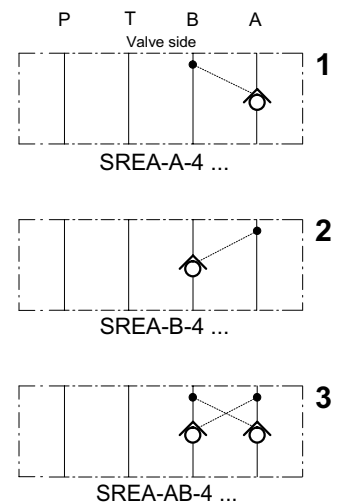

SUBJECT TO CHANGE WITHOUT NOTICE

DESCRIPTION

Series SREA-...-4 units are pilot operated check valves which function automatically. The seat-type check valves ensure a near zero-leakage closure of the applicable service line(s).

The check valves block the effects both of external forces on the actuator and of internal leakage in other components.

To ensure that the pilot piston is fully unloaded, the related directional valve should preferably have a mid-position in which the service lines A and B are connected to T (HTF spool type G).

The \varnothing 3 mm location pin on the actuator face of the valve prevents incorrect mounting.

PRINCIPAL CHARACTERISTICS

Type	P.O. check slice valve pilot-to-open	Cracking pressure	1,0 bar (standard) 2,5 bar
Design	guided poppet / seat	Pilot area ratio	1 : 3,3
Mounting method	stack mounting	Fluids	hydraulic oils HL and HLP to DIN 51 524 other fluids - contact HTF
Size	ISO 4401-02-01 interface	Minimum fluid cleanliness	18/14 to ISO 4406 / Cetop RP70H 8 ... 9 to NAS 1638
Mass	0,37 kg	Fluid temperature range	-20° ... +60° C
Mounting attitude	unrestricted	Viscosity range	10 ... 300 cSt
Flow direction	see symbols	Flow rate, Q max.	25 l/min
Operating pressure	... 250 bar in P, A, B and T ... 160 bar in T if used with WEDA-...-4 directional valve (data sheet W-12.00)		

S2Z-1587

SCHEMATIC SECTION

showing the relevant ports

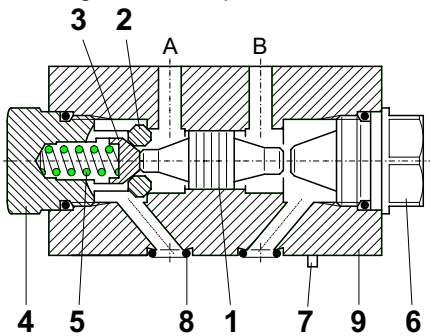

COMPONENTS / SERVICE PARTS

It.	Qty.	Description	
1	1	Spool	∅ 10 x 21,4
2	2	Seat ring	∅ 12 x 3
3	2	Poppet	∅ 7 x 9,9
4	2	Threaded guide housing	∅ 18 x 17,5
5	2	Spring 1,0 bar	0,4 x 3,4 x 15,2 iG = 15,5
	2	Spring 2,5 bar	0,5 x 3,5 x 15,2 iG = 15,5
6	-	Blanking plug	∅ 18 x 20
7	1	Roll pin	∅ 3 x 6 DIN 1481
	1	Seal kit no. DS-210, comprising *):	
8	4*)	O-ring no. 010	∅ 6,07 x 1,78 N90
9	1	Sandwich body Type O-4	35 x 35 x 50

*) = part of seal kit no. DS-210

▲ = available as service part

INSTALLATION AND SERVICING

MUST BE CARRIED OUT WITH CARE, AND BY QUALIFIED PERSONNEL ONLY.

At installation, be sure to mount the valve the correct way up. Do not confuse the flat surface (directional valve side) and the surface with O-ring counterbores (actuator side).

When changing seals, the new seals should be thoroughly oiled or greased before fitting them to the valve.

Do not remove the threaded guide housing (item 4) as this can disturb the function and sealing integrity of the valve.

PERFORMANCE CHARACTERISTICS

(Oil viscosity 33 cSt)

TO ORDER SERVICE PARTS, STATE:

- complete unit model code from the nameplate, including the design number.
- part description from above list.
- part item number from above list.
- data sheet number, including issue date
- quantity required

SREA-A-4/SREA-B-4

SREA-AB-4

Δp -Q characteristics with no CV (i.e. past blanking plug)

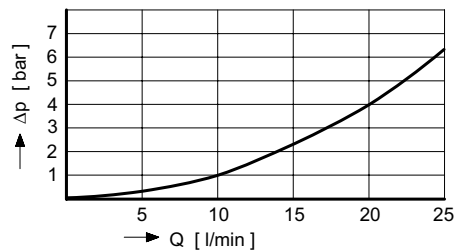

Δp -Q characteristics through check valve

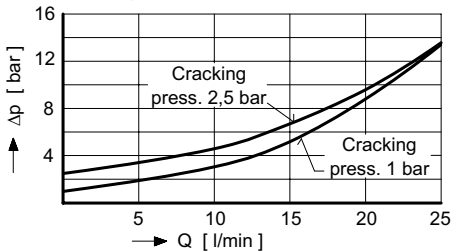

Δp -Q characteristics with CV piloted open

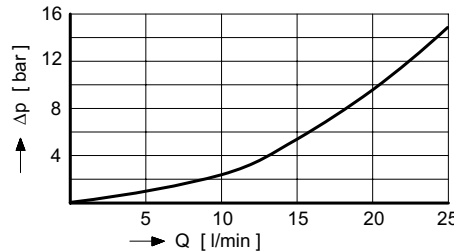

MODEL CODE KEY

- S = stacking valve
- RE = pilot operated check valve
- A ... Q = **standard** model per current data sheet
- Z ... R = special features by arrangement
- A = function in A
- B = function in B
- AB = function in A and B
- 4 = ISO 4401-02-02 interface
- 10 = cracking pressure 1,0 bar (**standard**)
- 25 = cracking pressure 2,5 bar
- (Blank) = Nitrile seals (**standard**)
- V = Viton seals
- For special seals, contact HTF
- 1 ... 9 = design number (omit when ordering)

Ex. S RE A - A - 4 - 10 - - - 1

RELATED DATA SHEETS

i-30 = ISO 4401-02-01 interface