

Automation systems

Drive solutions

Controls

Inverter

Motors

Gearboxes



Engineering Tools

Automation systems: Controller-based Automation

Controls: Panel PC v800, Monitor v200, Controller 3200 C, Controller c300, Controller p500, Controller p300, I/O System 1000

Contents of the L-force catalogue

About Lenze		Lenze makes many things easy for you. A matter of principle: the right products for every application. L-force product portfolio			
Automation systems		Controller-based Automation Drive-based automation	1.1 1.2		
Drive solutions		HighLine tasks StateLine tasks Baseline tasks	2.1 2.2 2.3		
Controls	Visualisation	Panel PC v800 Monitor v200	3.1 3.2		
	Cabinet Controllers	Controller 3200 C Controller c300	3.3 3.4		
	Panel Controllers	Controller p500 Controller p300	3.5 3.6		
		I/O System 1000	3.7		
Inverter	Decentralised	Inverter Drives 8400 protec	4.1		
		Inverter Drives 8400 motec	4.2		
	Cabinet	Servo Drives 9400 HighLine	4.3		
		Inverter Drives 8400 TopLine	4.4		
		Servo-Inverter i700	4.5		
		Inverter Drives 8400 HighLine	4.6		
		Inverter Drives 8400 StateLine	4.7		
		Inverter Drives 8400 Baseline	4.8		
Motors	Servo motors	MCS synchronous servo motors	5.1		
		MCM synchronous servo motors	5.2		
		MD□KS synchronous servo motors	5.3		
		MQA asynchronous servo motors	5.4		
		MCA asynchronous servo motors	5.5		
	Three-phase AC motors	IE3 three-phase AC motors m540/m550-P	5.6		
		Inverter opt. three-phase AC motors MF	5.7		
		IE2 MH three-phase AC motors	5.8		
		IE1 MD three-phase AC motors	5.9		
		Lenze Smart Motor m300	5.10		
		IE3 three-phase AC motors m240-P	5.11		
		IE1/2 three-phase AC motors Basic MD/MH	5.12		
		Gearboxes	Axial gearboxes	g700-P planetary gearbox	6.1
				MPR/MPG planetary gearboxes	6.2
g500-H helical gearboxes	6.3				
g500-S shaft-mounted helical gearbox	6.4				
Right-angle gearboxes	g500-B bevel gearbox		6.5		
Motor data	Assignment see above		6.6		
Engineering Tools	Navigator		7.1		
	Drive Solution Designer	7.2			
	Drive Solution Catalogue	7.3			
	Engineer	7.4			
	PLC Designer	7.5			
	VisiWinNET®	7.6			
	EASY Starter	7.7			

 Selected portfolio
 Additional portfolio

Lenze makes many things easy for you.

With our motivated and committed approach, we work together with you to create the best possible solution and set your ideas in motion - whether you are looking to optimise an existing machine or develop a new one. We always strive to make things easy and seek perfection therein. This is anchored in our thinking, in our services and in every detail of our products. It's as easy as that!

1

Developing ideas

Are you looking to build the best machine possible and already have some initial ideas? Then get these down on paper together with us, starting with small innovative details and stretching all the way to completely new machines. Working together, we will develop an intelligent and sustainable concept that is perfectly aligned with your specific requirements.

2

Drafting concepts

We see welcome challenges in your machine tasks, supporting you with our comprehensive expertise and providing valuable impetus for your innovations. We take a holistic view of the individual motion and control functions here and draw up consistent, end-to-end drive and automation solutions for you - keeping everything as easy as possible and as extensive as necessary.

3

Implementing solutions

Our easy formula for satisfied customers is to establish an active partnership with fast decision making processes and an individually tailored offer. We have been using this principle to meet the ever more specialised customer requirements in the field of machine engineering for many years.

4

Manufacturing machines

Functional diversity in perfect harmony: as one of the few full-range providers in the market, we can provide you with precisely those products that you actually need for any machine task – no more and no less. Our L-force product portfolio, a consistent platform for implementing drive and automation tasks, is invaluable in this regard.

5

Ensuring productivity

Productivity, reliability and new performance peaks on a daily basis – these are our key success factors for your machine. After delivery, we offer you cleverly devised service concepts to ensure continued safe operation. The primary focus here is on technical support, based on the excellent application expertise of our highly-skilled and knowledgeable after-sales team.

A matter of principle: the right products for every application.

Lenze's extensive L-force product portfolio follows a very simple principle. The functions of our finely scaled products are assigned to the three lines Base-Line, State-Line or High-Line.

But what does this mean for you? It allows you to quickly recognise which products represent the best solution for your own specific requirements.

Powerful products with a major impact:

- Easy handling
- High quality and durability
- Reliable technologies in tune with the latest developments

Lenze products undergo the most stringent testing in our own laboratory. This allows us to ensure that you will receive consistently high quality and a long service life. In addition to this, five logistics centres ensure that the Lenze products you select are available for quick delivery anywhere across the globe. It's as easy as that!

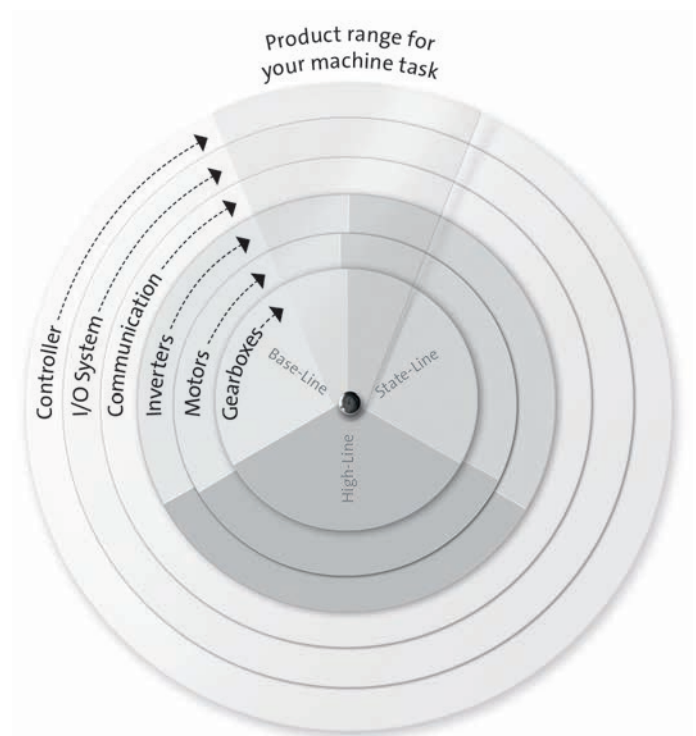

L-force product portfolio

Controls

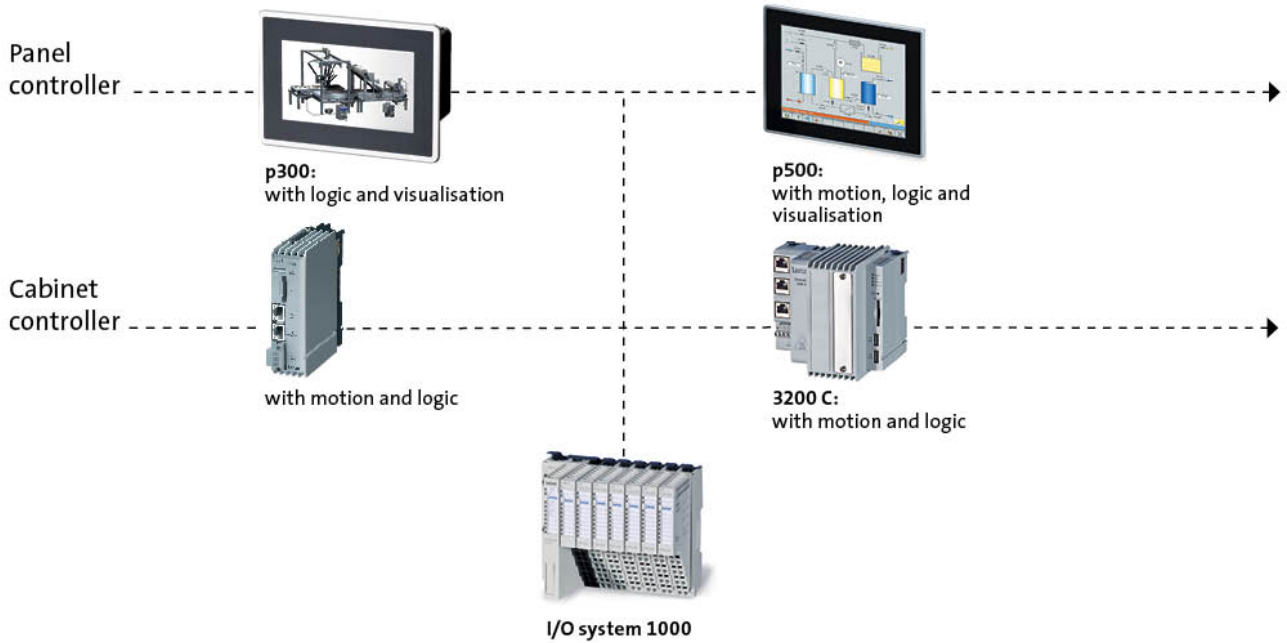

Engineering Tools

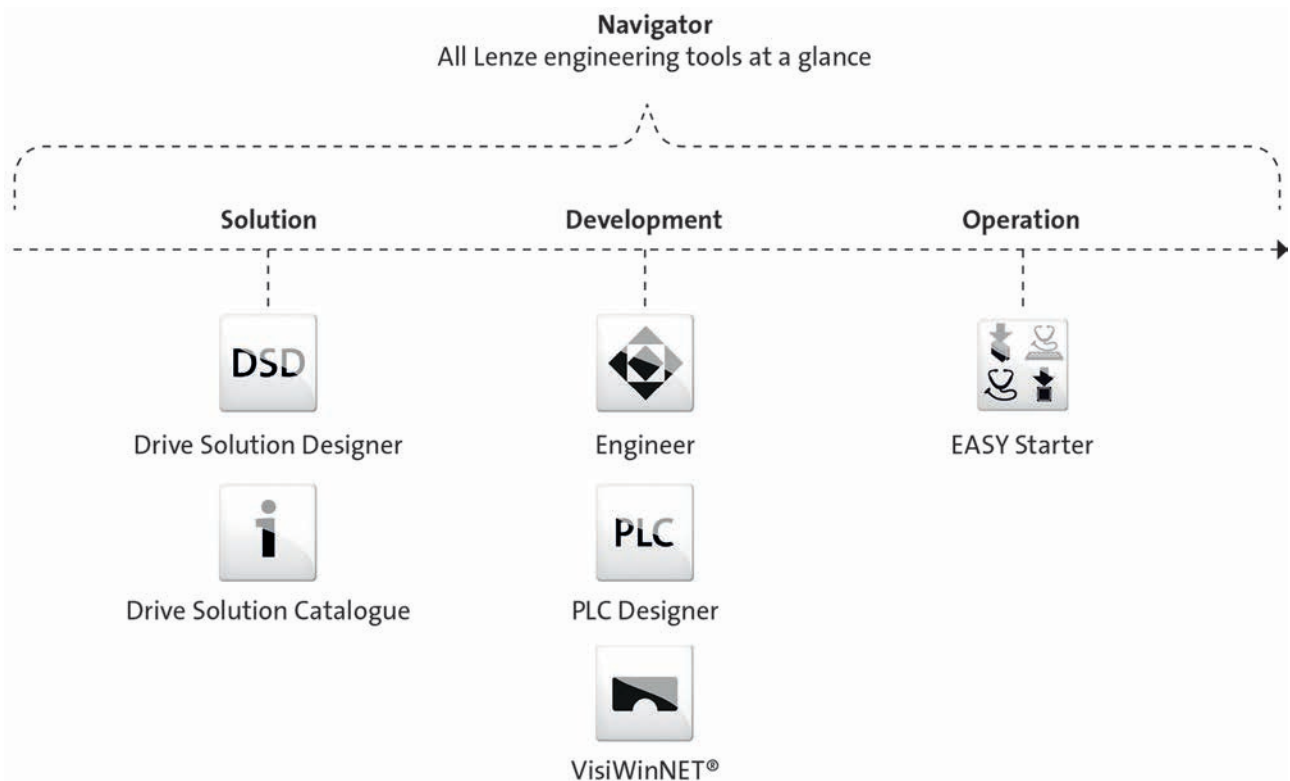

L-force product portfolio

Inverter

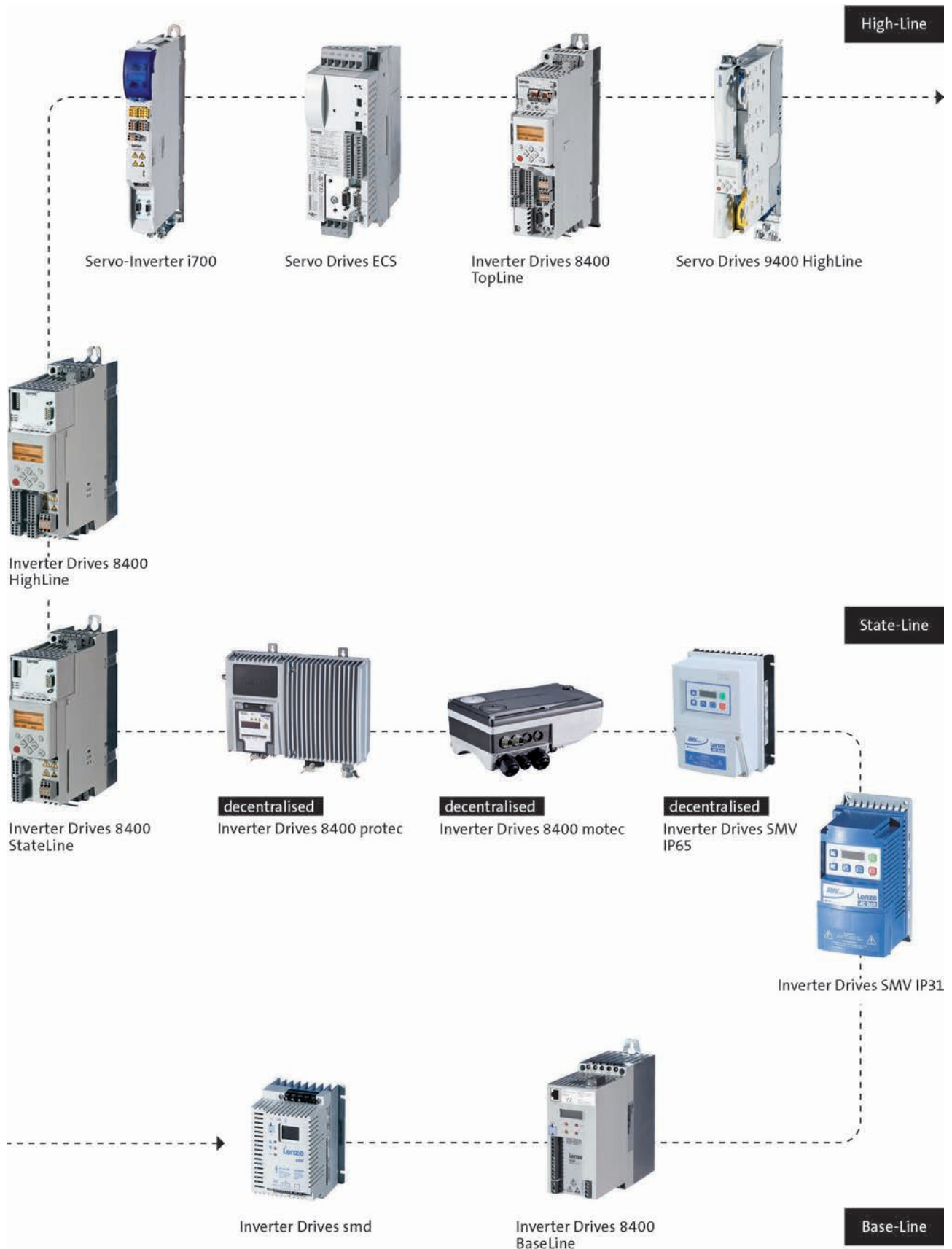

L-force product portfolio

Motors

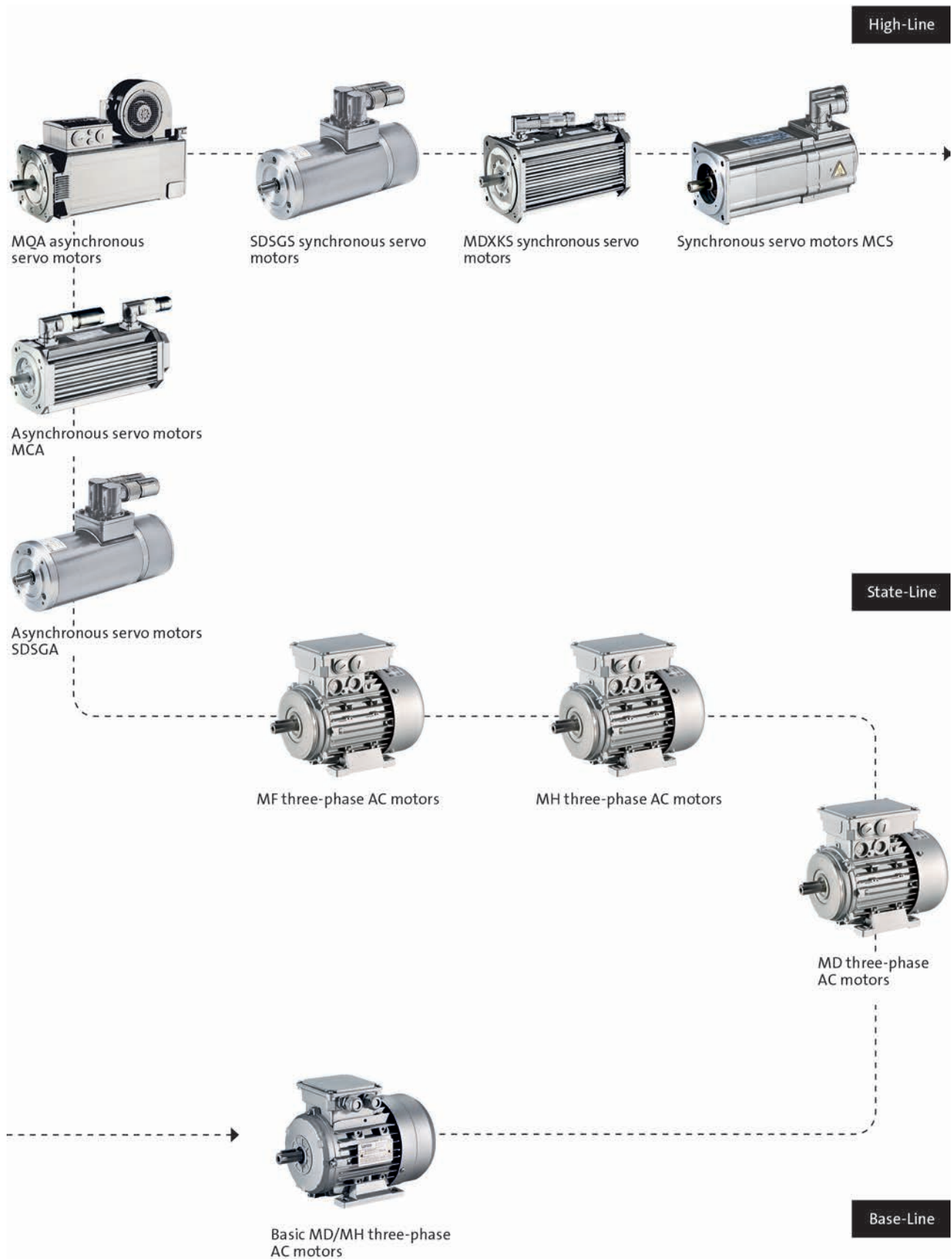

L-force product portfolio

Gearboxes

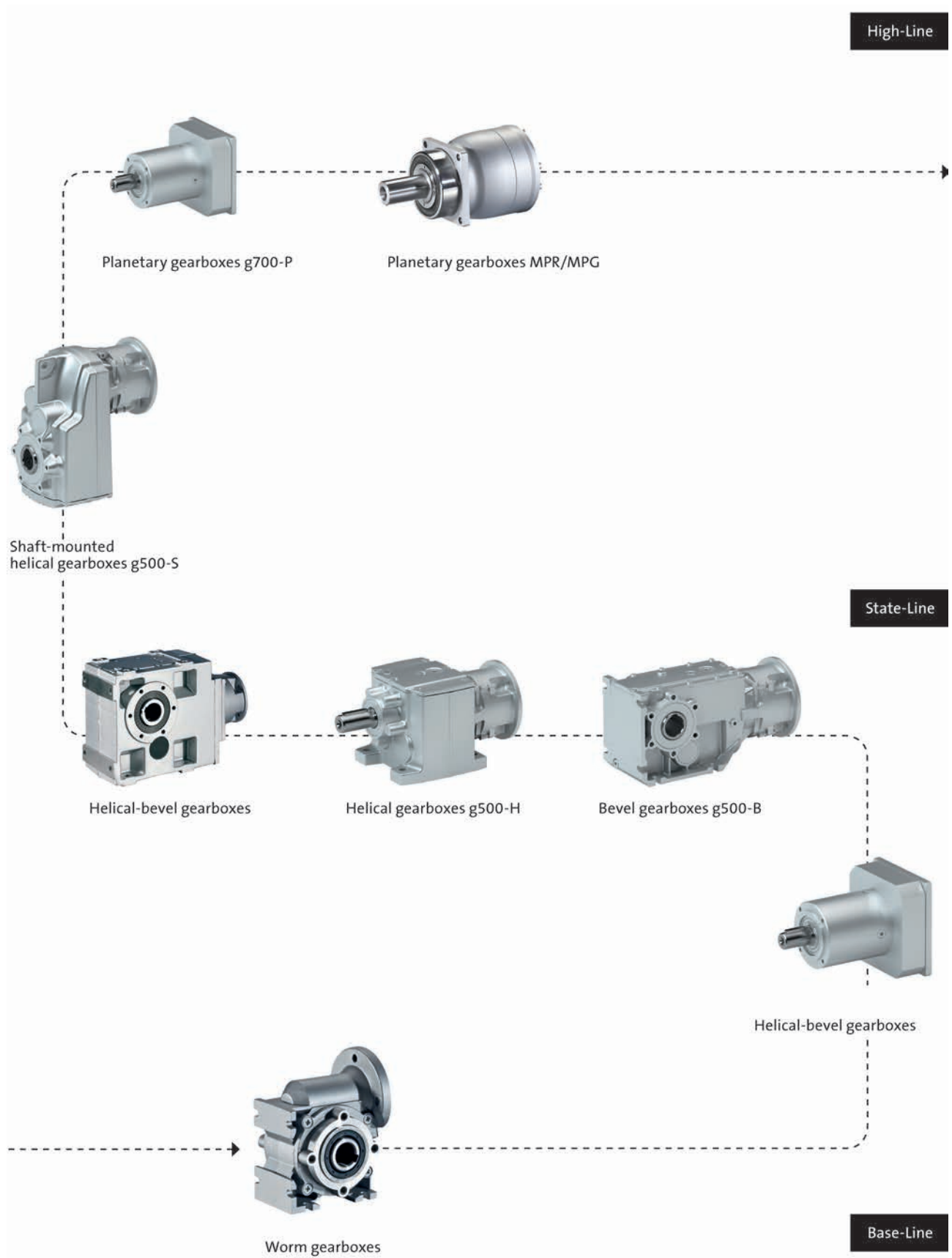

Controller-based Automation

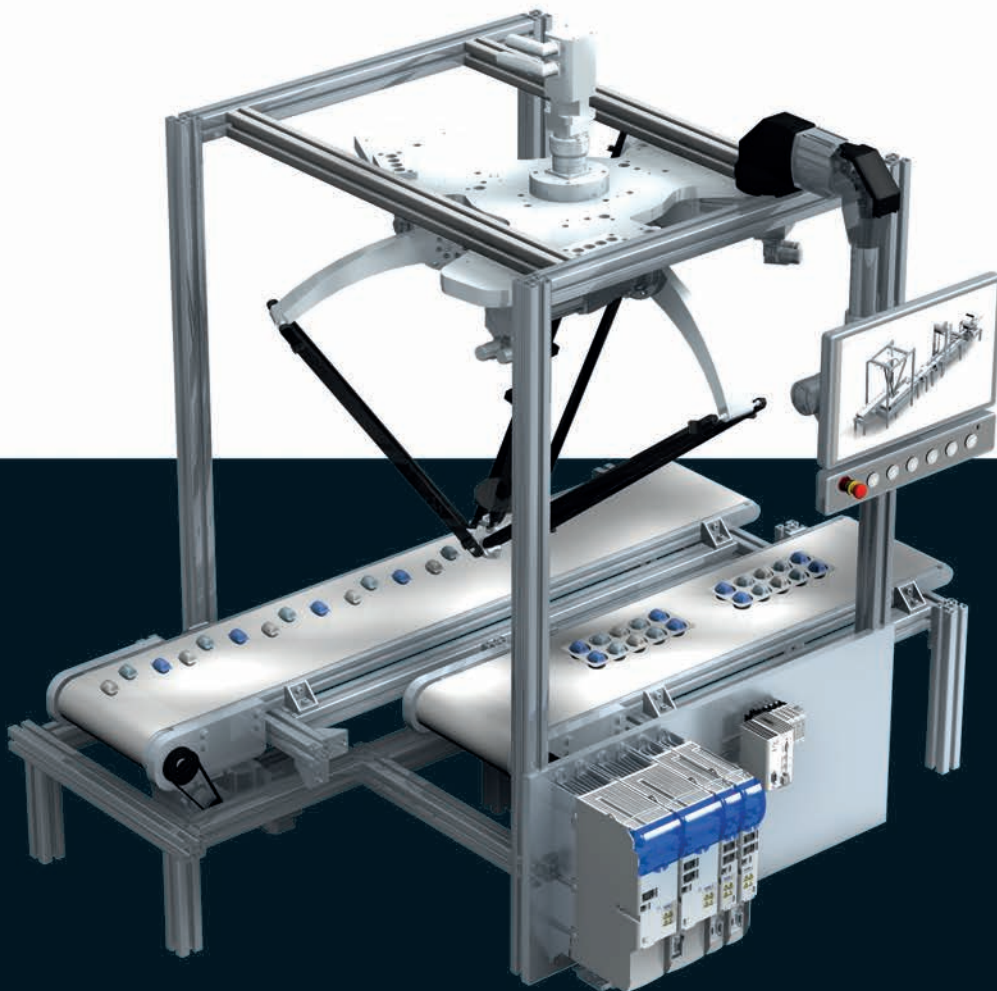

Controller-based Automation

Contents



General information	Automation with central motion control	1.1 - 4
Topologies	General information	1.1 - 6
	Standard topology with EtherCAT®	1.1 - 7
	Safety topology with EtherCAT®	1.1 - 8
	Advanced topology with CANopen	1.1 - 9
	Advanced topology with PROFIBUS	1.1 - 10
	Extended topology with PROFINET	1.1 - 11
Application Software	The basis	1.1 - 12
	FAST Application Software	1.1 - 13
	FAST Application Template	1.1 - 14
	FAST technology modules	1.1 - 15
	FAST Motion	1.1 - 18
Application areas	Functions and features	1.1 - 19
Engineering	Handling, commissioning and diagnostics	1.1 - 20

Controller-based Automation

General information



1.1

Automation with central motion control

Complex machines such as robots, packaging machines and handling systems require a powerful, uniform and end-to-end automation system with a central control system. This allows coordinated movement of many axes and is also capable of performing control functions for a linear process. For project engineers, the central architecture offers the additional advantage that only one control program has to be developed and managed. We call this Controller-based Automation for central motion control.

To address the increasing complexity of your automation tasks efficiently and cost-effectively, alongside a uniform, end-to-end automation system you also expect your automation supplier to provide you with advanced engineering tools and, if necessary, qualified support. Lenze offers you experienced experts in sales and support that can help you, whatever issues you are experiencing. No matter whether you are seeking support for project planning, dimensioning, selecting the right components or programming a mechatronic solution, we are here to help.

In Europe alone, customers have access to a network of over 100 highly-qualified application engineers with extensive expert knowledge and sector expertise. All-around service, training sessions and a helpline that can be accessed from anywhere in the world round off our portfolio of services.

Components in Lenze's Controller-based Automation system include the controllers, a wide range of inverters with matching standard three-phase AC motors, as well as synchronous servo motors and asynchronous servo motor, each of which can be combined with various types of gearboxes all the way up to decentralised I/O systems.

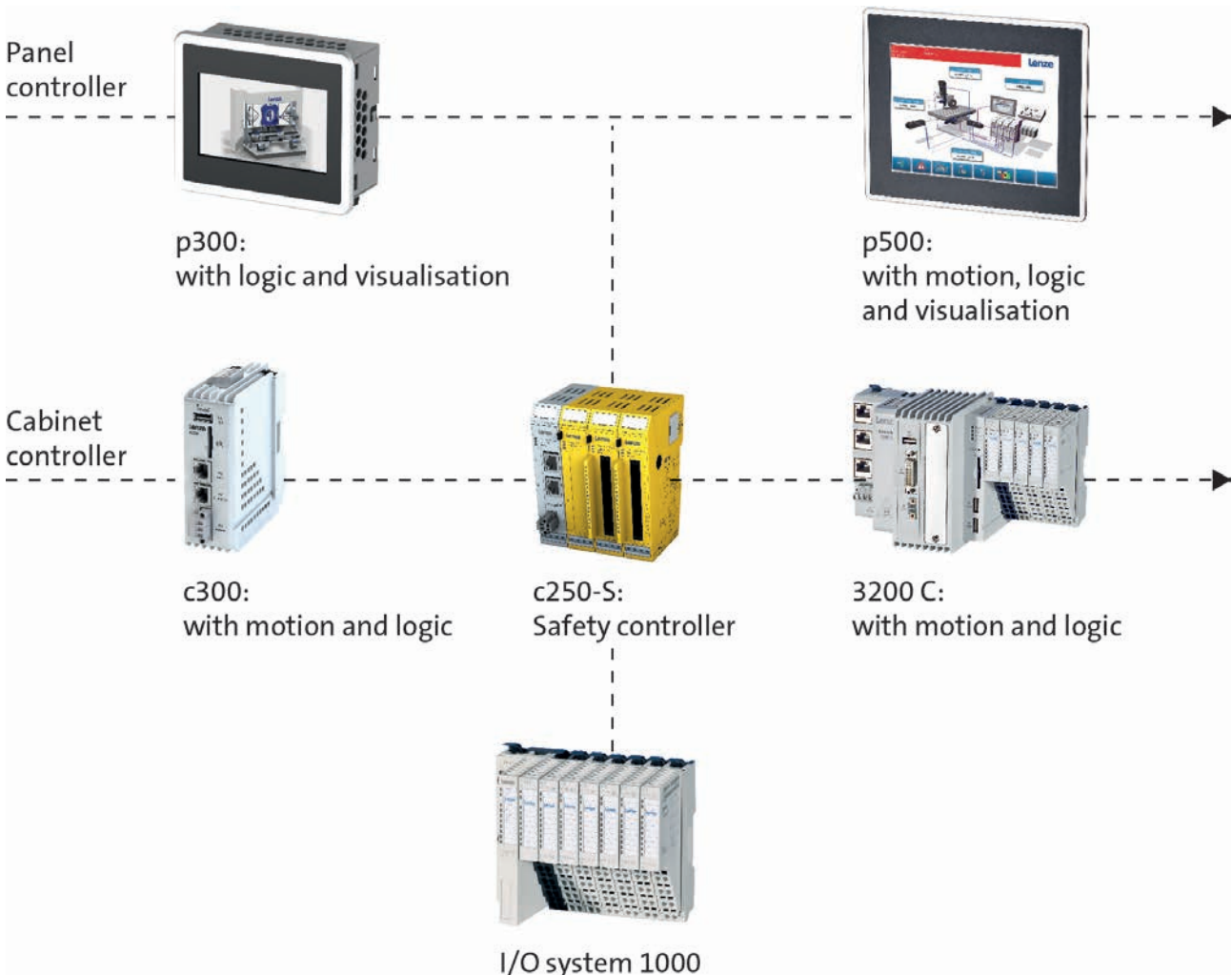

Controller-based Automation

General information



Automation with central motion control

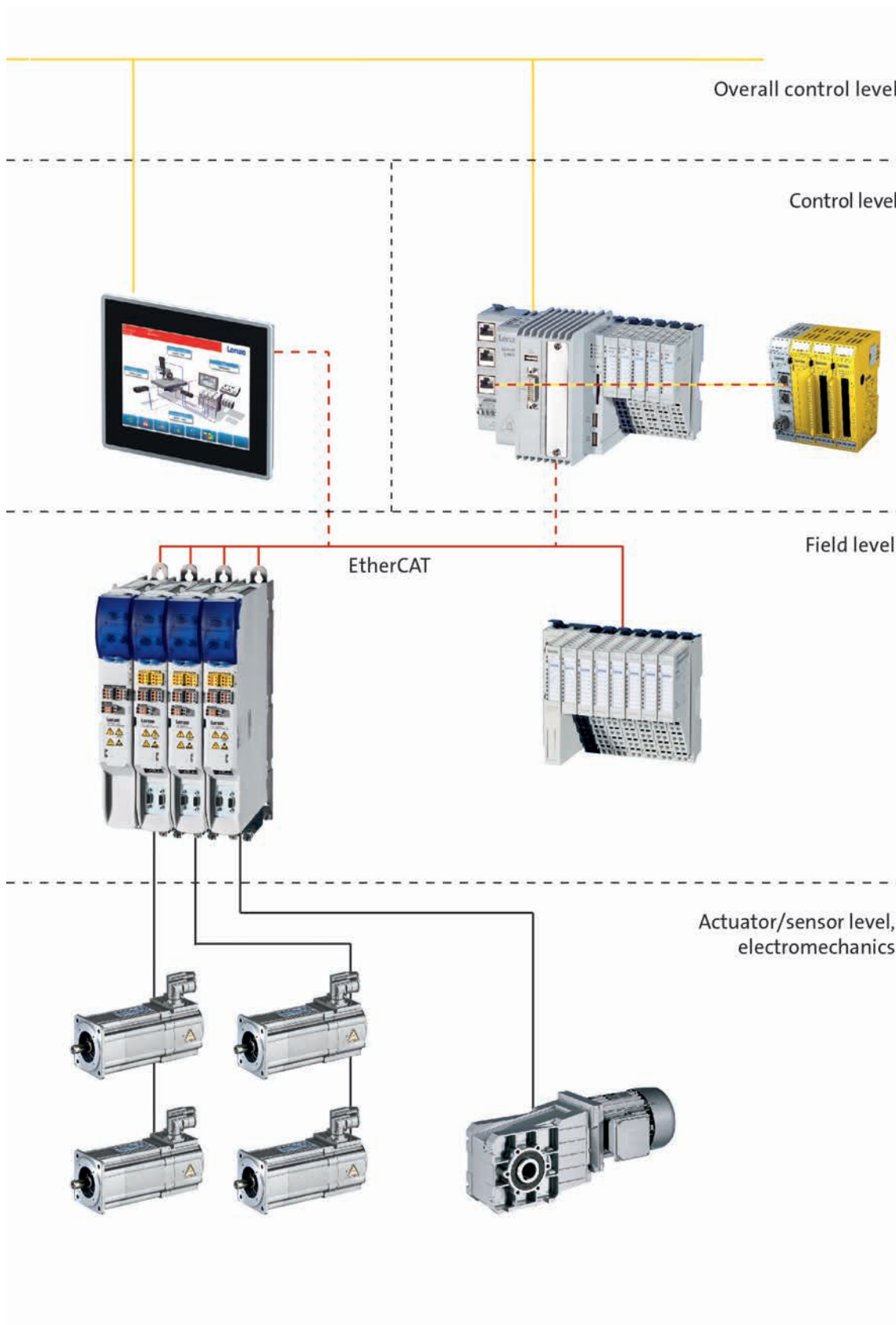

1.1

Controller-based Automation

Topologies



General information

1.1

For Controller-based Automation, Lenze offers flexible solutions for system topologies. For self-sustaining solutions, simply rely on the bus systems used by Lenze such as the well-established CANopen or the fast, flexible EtherCAT.

In addition, Lenze offers easy integration into systems with higher-level controls or into existing systems.

The use of the Lenze Engineering tools can be provided for by any type of system bus. Each controller provides an additional Ethernet connection, enabling access of the Engineering tools to the controllers right down to the drives. Programming, commissioning, or diagnostics can therefore be carried out easily also in remote maintenance scenarios.

Controller	c300	p300	3200C	p500
Runtime				
FAST Runtime	●	●	●	●
FAST Motion	●		●	●
Visualisation		●	● 1)	●
Communication				
EtherCAT Master	Integrated	Integrated	Integrated	Integrated
CANopen	Integrated	Integrated	Option	Option
PROFIBUS Master			Option	
PROFIBUS Slave			Option	Option
PROFINET Device	Option	Option	Option	Option
Safety Controller				
c250-S	About EtherCAT ²⁾ Controller based Safety ²⁾	About EtherCAT ²⁾ Controller based Safety ²⁾	About EtherCAT Controller based Safety	About EtherCAT ²⁾ Controller based Safety ²⁾

¹⁾ With monitor panel via DVI interface.

²⁾ In preparation.

Controller-based Automation

Topologies



Standard topology with EtherCAT®

The Ethernet-based bus system EtherCAT® is the standard topology for Controller-based Automation applications and offers a large range of potential applications.



1.1

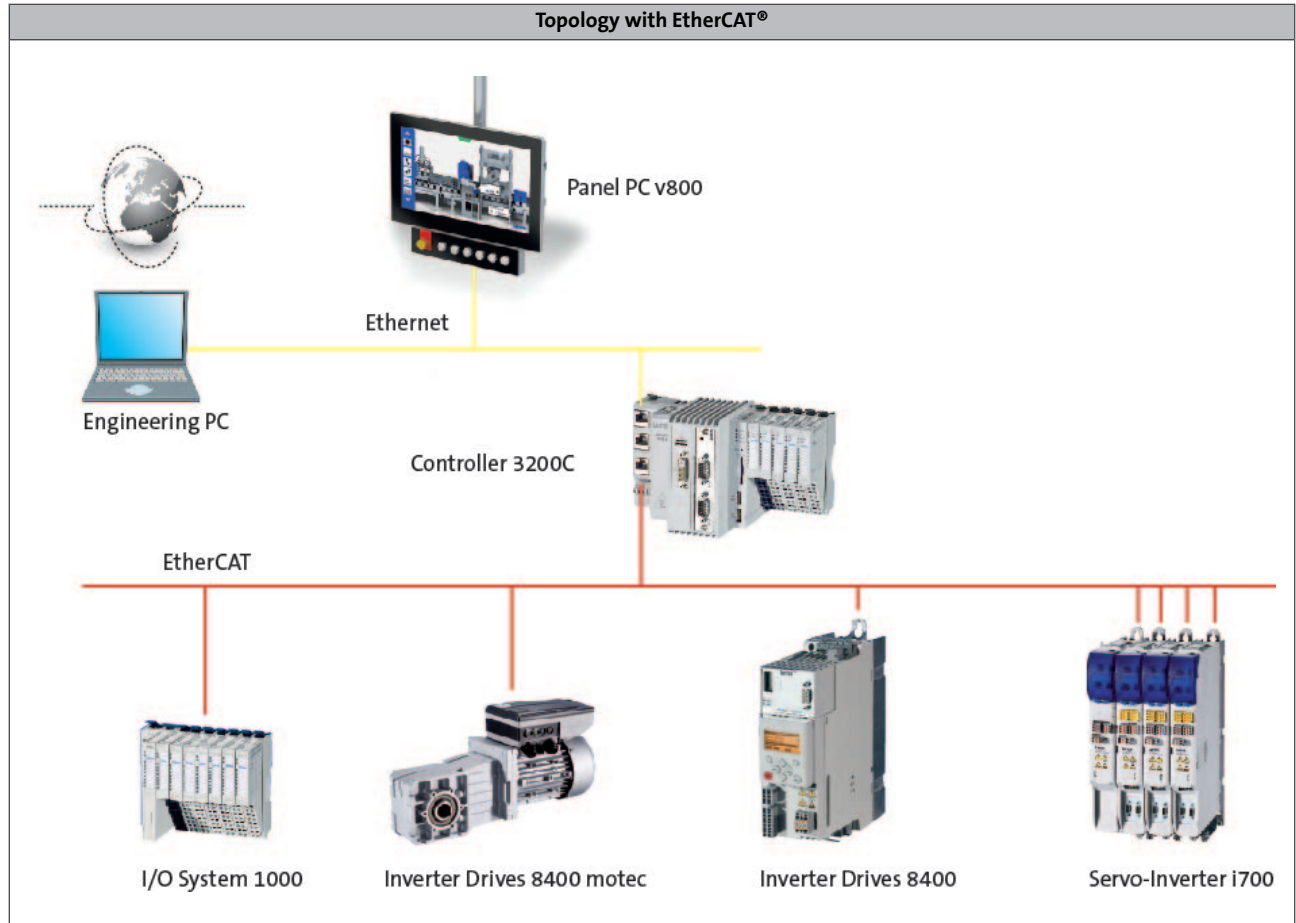

Controller-based Automation

Engineering



1.1

Safety topology with EtherCAT®

From drive-based safety to controller-based safety: this new simplicity can be seen among other things in the noticeably reduced amount of wiring.

This is the result of directly interlinking the Lenze controllers for safety and motion – in addition to ready-made software solutions from the FAST Application Software Toolbox.

Hence in practice, a FAST module can, for instance, control the reduction in traversing speed while at the same time the safety controller within the system can monitor the safe maximum speed.

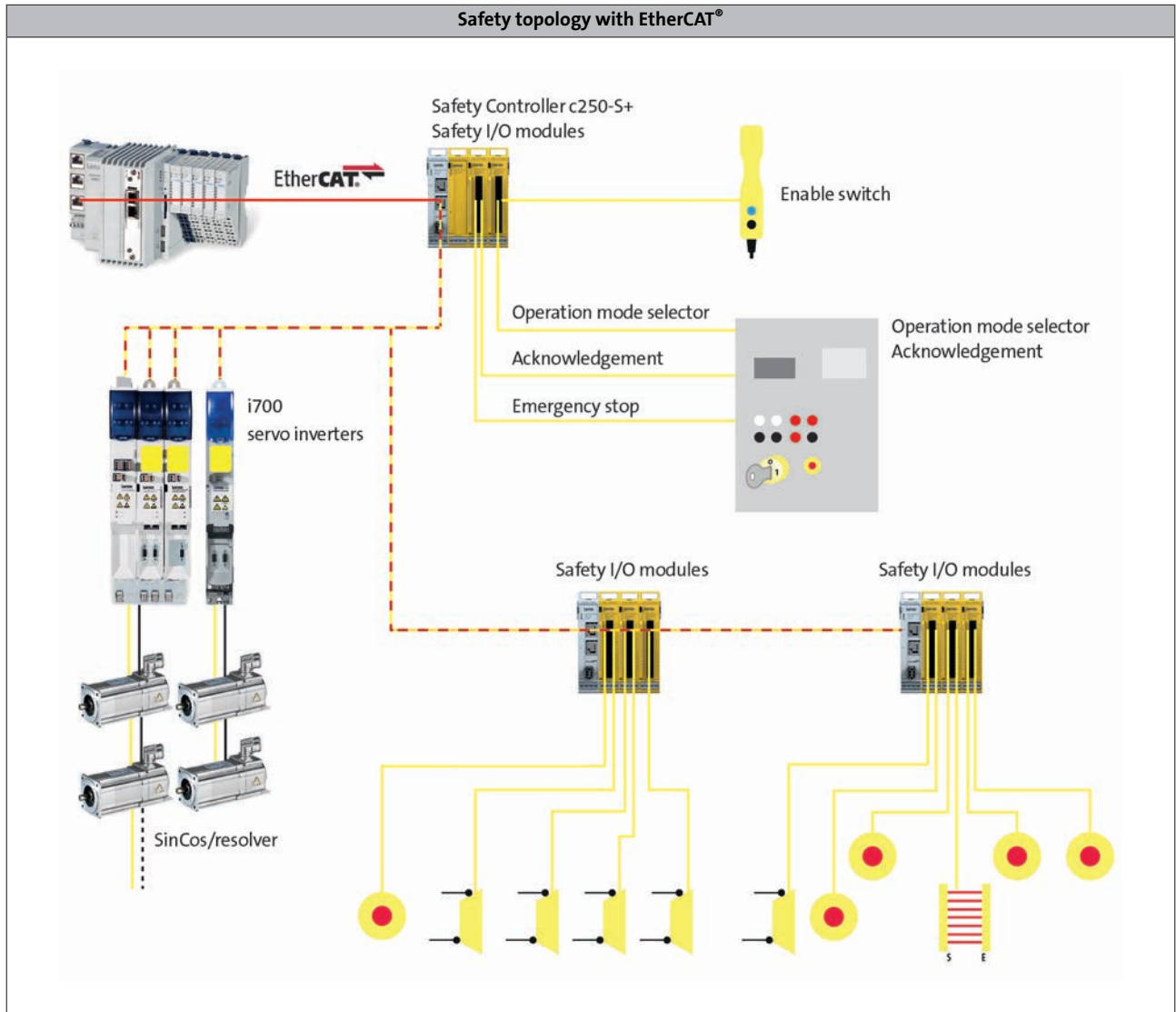

Controller-based Automation

Topologies



Advanced topology with CANopen

The tried-and-tested CAN bus comes as standard on many field devices. The controllers therefore allow CANopen to be used, some controllers even allow it in addition to the EtherCAT as a double master system. In this topology, a separation of motion and logic bus is recommended.



1.1

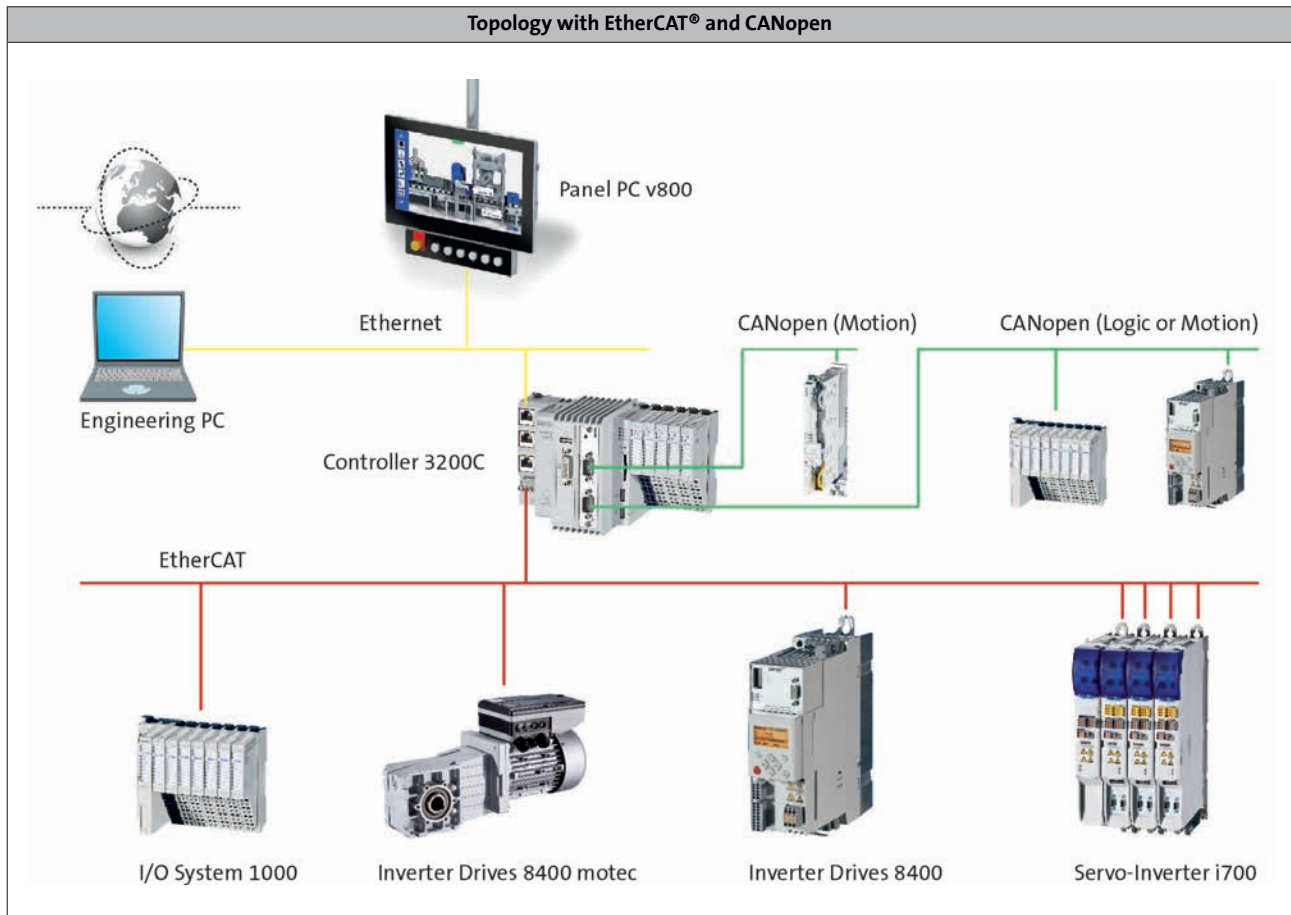

Controller-based Automation

Topologies



Advanced topology with PROFIBUS

PROFIBUS is the most widely used fieldbus in today's automation technology industry. The choice of available field devices is immense. The expansion of control technology to include PROFIBUS means that this diversity is now also available within FAST Runtime.



1.1

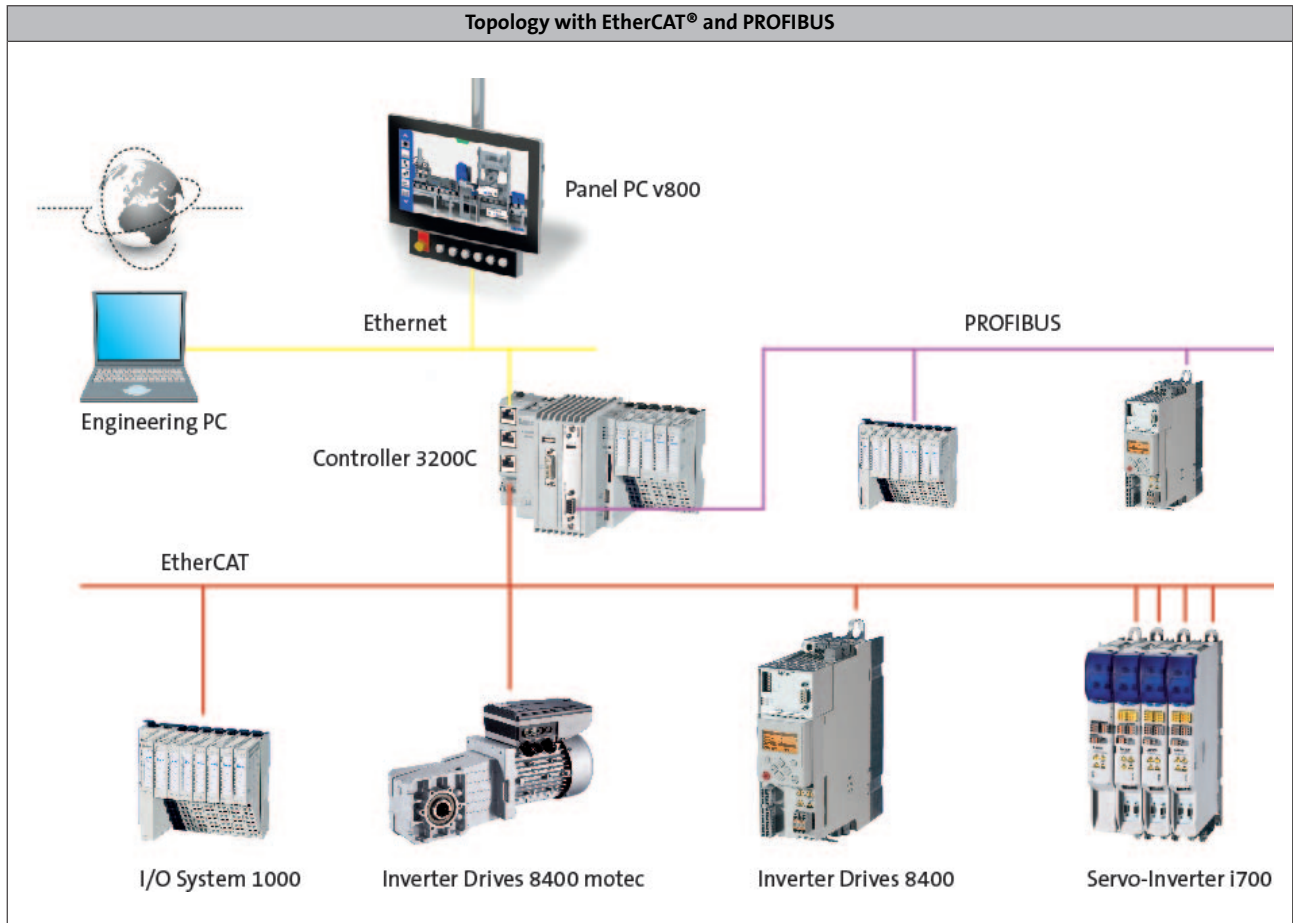

Controller-based Automation

Topologies



Extended topology with PROFINET

As a direct successor of PROFIBUS, PROFINET is becoming increasingly important. With this new generation, we are now also focusing on TCP/IP and Ethernet Standard in the field of communication. The direct integration of this interface makes it possible to integrate Lenze controllers quickly and easily into PROFINET systems.



1.1

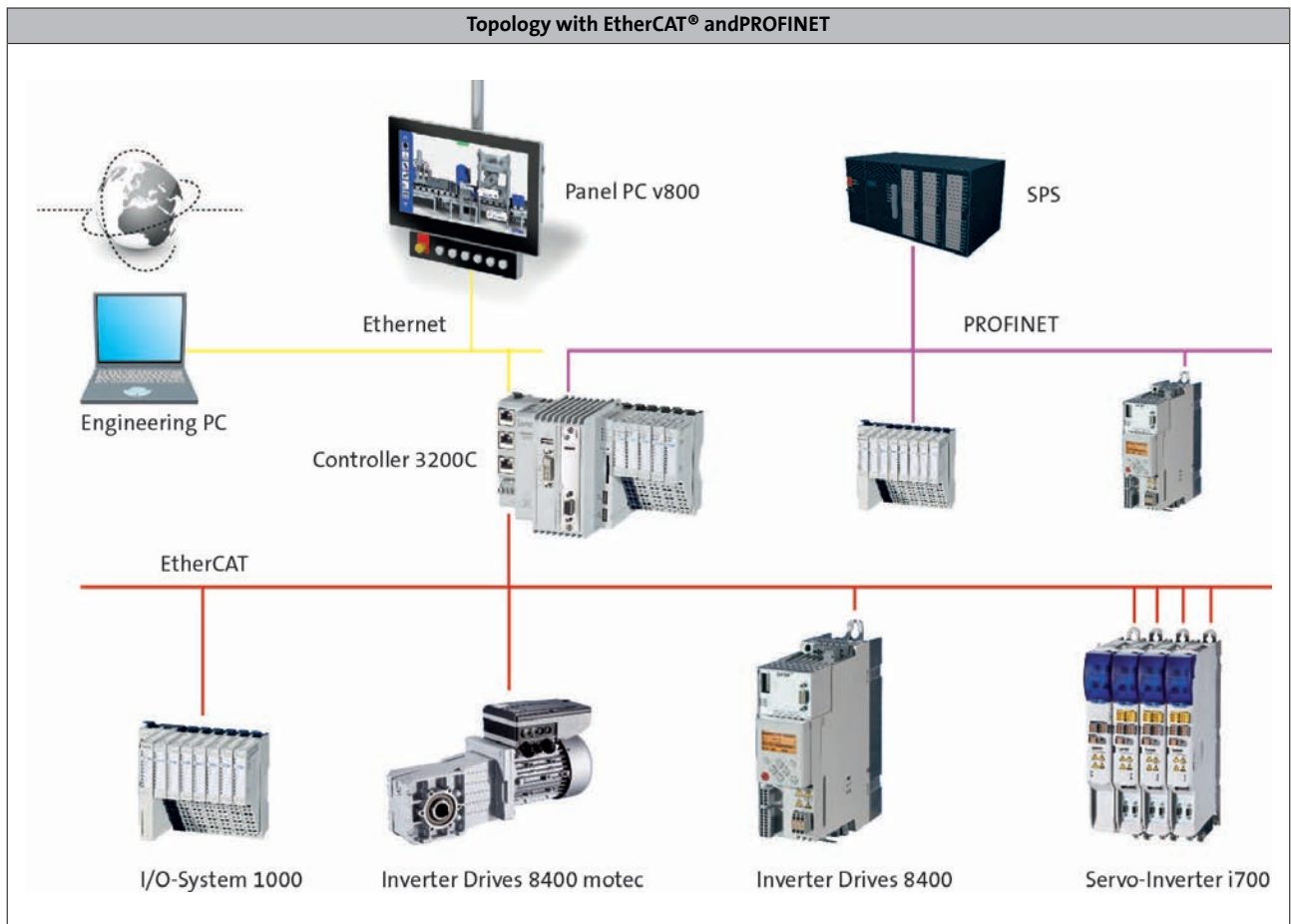

Controller-based Automation

Application Software



The basis

The runtime software in a Controller determines the type of functions to be executed. The runtime software is available in the "FAST Runtime" and "Visu" versions.

FAST Runtime

The "FAST Runtime" runtime software enables the Controller to execute a sequence control (PLC functionality according to IEC 61131-3).

Moreover, Lenze FAST features licenced, predefined and already tested standard software modules (FAST technology modules) for an easy development of a modular machine control. FAST Motion modules (based on "PLCopen motion control) can be used to individually extend the functionalities of the FAST technology modules. – With Lenze FAST you only pay the functionalities you really need!

The PLC programming is carried out with the »PLC Designer« engineering tool. The FAST technology modules and FAST Motion modules are contained in »PLC Designer« function libraries and can be easily integrated into the machine program.

Controller-based Automation

Application Software



FAST Application Software

The topic of software is becoming increasingly important in developing machines as mechanical engineers are focusing more attention on efficient processes for creating the applications they need.

Lenze FAST (Feasibly Applicable Software Toolbox) provides Lenze standard software modules for easily developing a modular machine control.

For this purpose, the »PLC Designer« engineering tool with the "FAST Application Template" provides for an easy programming and commissioning as standardised software structure and with predefined technology modules. FAST Motion functions serve to implement individual extensions.

Highlights

- Up to 80 % of the software engineering for the motion control of the machine can be covered by standards.
- Considerable reduction of the development times for the basic drive functions
- Saved time can be invested in the further development of the special features of the machine.
- Predefined and tested software modules
- Structured programming
- Easier reuse and extension of programming segments
- Error reduction by tested software

1.1

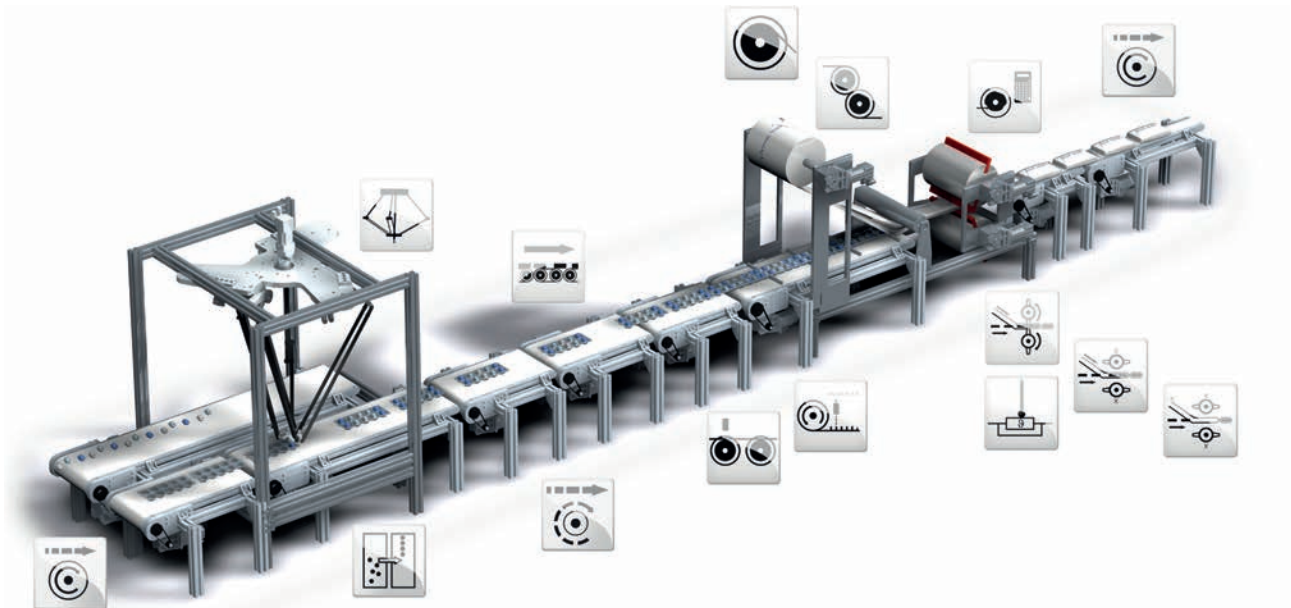

Controller-based Automation

Application Software



FAST Application Template

The FAST Application Template is standardised by Lenze for a modularised and clear programming in the »PLC Designer«.

For a modular implementation of the mechatronic structure of an automation system, ready-made and reusable machine modules and module applications (e.g. a cross cutter) can be generated in the FAST Application Template.

The FAST Application Template can be used via a library in the »PLC Designer« (from version 3.3). The library contains the structure and basic functionality of the FAST Application Template (as, for instance, state machine and error handling).

FAST Application Template elements

In order to map the automation system based on the FAST Application Template in the »PLC Designer«, the structure of the entire machine application has to be divided into machine modules. Each subfunction or drive function of the machine (e.g. "cross cutter" or "conveying belt") is mapped in one machine module.

A machine module always comes with at least one module application. Up to three module applications per machine module are possible.

The FAST Application Template supports two up to five hierarchy levels with up to 30 machine modules.

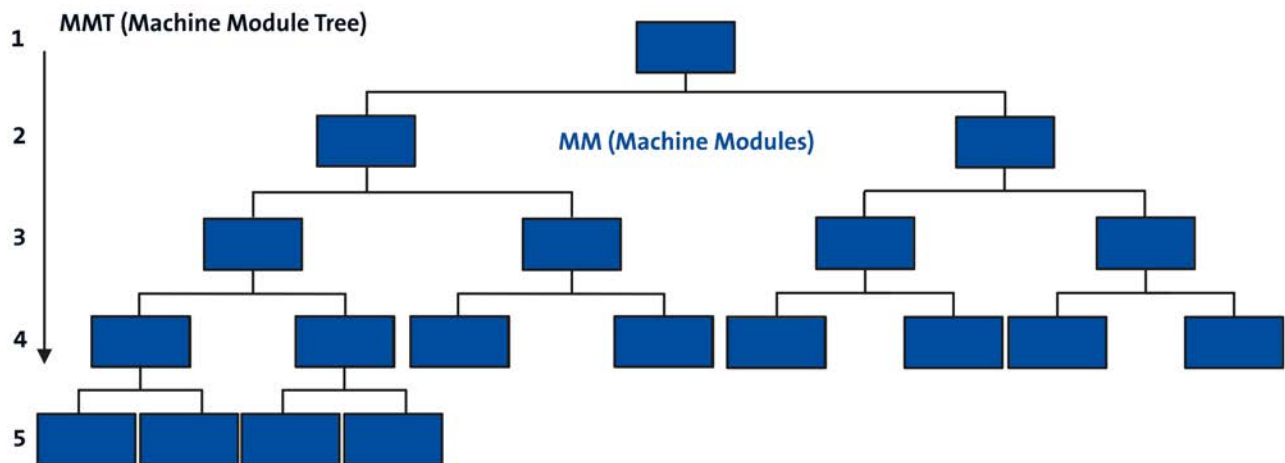

Example of a machine structure tree (MMT) with five levels

PackML standard

The FAST Application Template PackML standard is an extension that fulfils the requirements of the OMAC (Organization for Machine Automation and Control) user organisation for open and modular automation solutions for packaging machines according to the "PackML" standard.

Controller-based Automation

Application Software



FAST technology modules

The predefined FAST technology modules serve to easily implement the desired machine functions.

The FAST technology modules are standardised software modules for a modular programming of the machine control. A FAST technology module features a complete and pre-tested drive function.

Integrated basic functions and an integrated visualisation provide for an easy commissioning and testing of the modules. The reusability of the modules increases the quality of the software and considerably reduces the time required for programming, commissioning and testing.

1.1

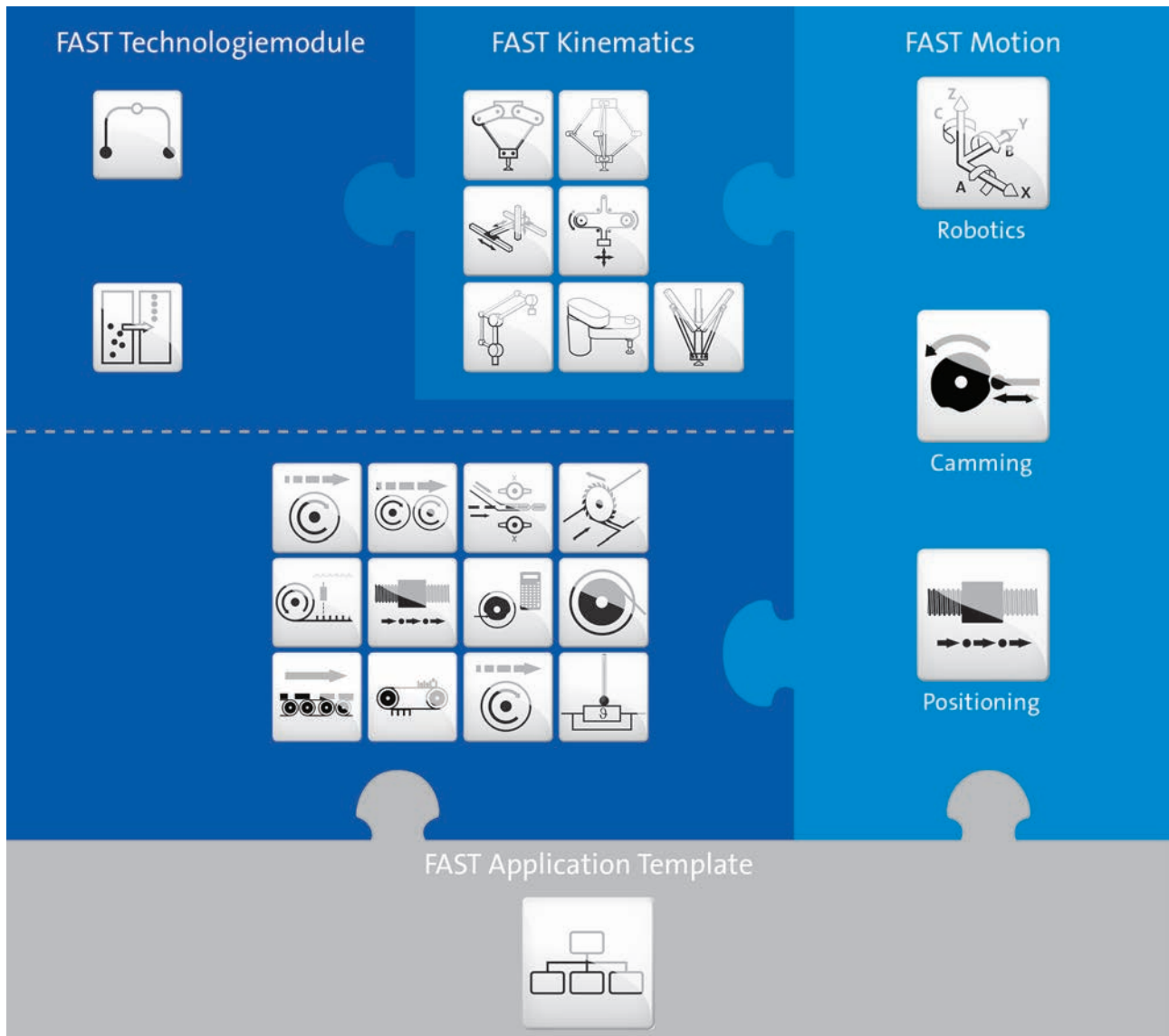

The FAST technology modules are contained in the »PLC Designer« as independent function blocks in a library. They use the standardised interfaces and can thus be easily integrated into the machine program, combined in any way and extended individually with FAST Motion functions.

Using the FAST technology modules requires a licencing via Application Credit, see controller accessories.

Controller-based Automation

Application Software



FAST technology modules

Each FAST technology module contains the basic functions manual jog, homing and positioning for the drives.

The following technology modules are available for applications with the motion control of a single drive axis:



Single drives

1.1

Technology module		Function
Virtual Master		Implementation of a virtual master axis in the machine
Basic Motion		Provides easy basic motion functions: Manual jog, homing, absolute and relative positioning, continuous travel
Electrical Shaft		Synchronisation and coupling of drives with precise speed and positioning.
Flex Cam		Implementation of one or several electric cams. Flexible management of curves created online and offline.
Cross Cutter		Synchronised movements of drives for cross-sealing and/or cross-cutting of products.
Register control		Implementation of a clock-synchronised drive for generating a register control with print mark detection.
Winder Dancer		Implementation of a winding drive with dancer position control and/or a winding drive with tensile force/speed control
Table Positioning		Positioning profiles for single axes with smoothing and touch probe positioning
Flying Saw		Cutting and processing of material while moving
Temperature Control		Control of the temperature of a system that is provided with a heating element and a thermal sensor.
Smart Track		Distribution of products via several conveying belts. An intelligent distribution results in optimum packaging of products.
Magic Track		The preparation of single products to package them in groups. Is implemented comfortably with the two-pass conveyor.

Controller-based Automation

Application Software



FAST technology modules



Coordinated multi-axes drives

1.1

Technology module		Function	Kinematics		Function
Pick&Place		Implementation of complex three-dimensional movements by means of profiles for up to four drives with different kinematics.	Portal		Universal Cartesian portal kinematics with 2, 3 and 4 degrees of freedom for Pick&Place with high load capacities and big workspaces
			Belt		Universally usable belt kinematics with 2 degrees of freedom *
			Delta 2		Parallel kinematics with 2 degrees of freedom * for highly dynamic Pick&Place tasks
			Delta 3		Parallel kinematics with 3 degrees of freedom * for highly dynamic Pick&Place tasks
			LinearDelta 3		Parallel kinematics with 3 degrees of freedom with linear axes for dynamic pick & place tasks.
			Scara		Universal serial Scara kinematics with 2 and 3 degrees of freedom
			Articulated P		Special form of an articulated arm kinematics with 4 degrees of freedom especially suitable for palletizing
Track Pick & Place		Implementation of gripper movements which, for instance, pick up workpieces from a conveying belt and place or position them onto another conveying belt			

* Further degrees of freedom in preparation.

Controller-based Automation

Application Software



FAST Motion

FAST Motion provides full flexibility and scalability for machine programming and comprises optimised function blocks based on "PLCopen motion control":

- "Motion Control" modules (based on PLCopen Motion Control (formerly part 1+2) are optimised for the basic functions "positioning" and "cams" (synchronising).
- "Coordinated Motion" modules (based on PLCopen Coordinated Motion (part 4) are optimised for multi-axis coordinated three-dimensional movements – which can also be controlled via the FAST technology modules "Pick & Place".

1.1

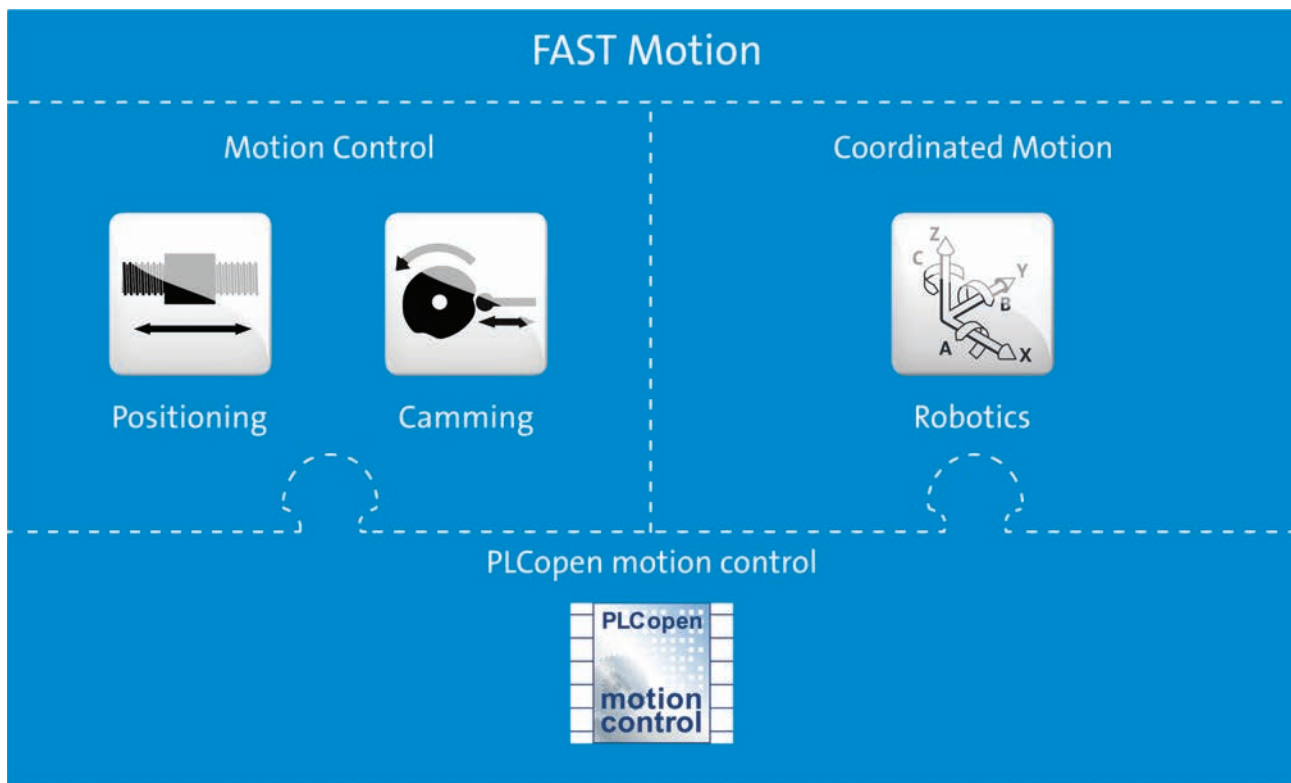

If the functionalities of the FAST technology modules are not sufficient, they can be supplemented individually with FAST Motion modules. This serves to easily create the machine function with pre-planned standards. Thus, FAST frees up time for what really matters.

The »PLC Designer« contains the "Motion Control" module in two libraries and the "Coordinate Motion" modules in one library. Detailed information on the library functions and the functional range of the technology modules can be found in the online help of the PLC Designer.

Controller-based Automation

Application areas



Functions and features

Servo-Inverter i700

The Servo-Inverter i700 is implemented into the Controller-based Automation solution via the Ethernet-based EtherCAT® bus system. Thus, a large variety of technology applications can be adopted via the implemented controller. The »PLC Designer« engineering tool serves to program the FAST Motion functions.

1.1

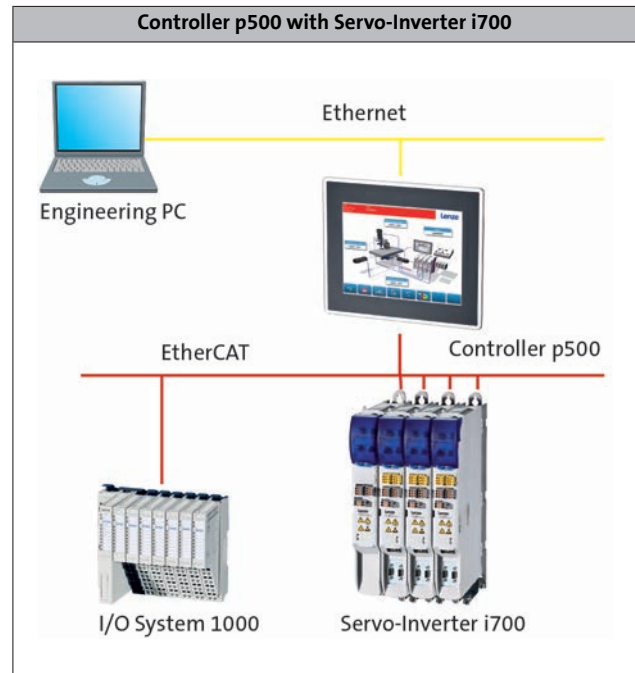
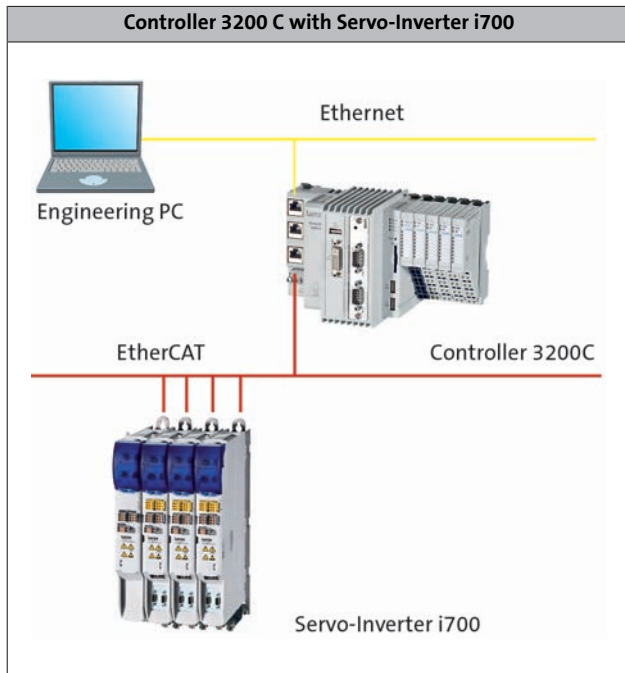

For the different controllers, cycle times of the setpoint selection depend on the number of axes and the functionalities. The following table shows typical values for "Motion Control" (based on PLCopen Motion Control, formerly Part 1+2) and "Coordinated Motion" (based on PLCopen Coordinated Motion, Part 4).

Mode			3221 C	3231 C	3251 C	p500
Controller						
Min. cycle time PLCopen part 1,2: Motion Control						
1 - 4 axes	t	[ms]	1	1	1	1
8 axes	t	[ms]	2	1	1	1
12 axes	t	[ms]	2	2	1	2
16 axes	t	[ms]	2	2	2	2
32 axes	t	[ms]	4	3	3	4
64 axes	t	[ms]	8	6	5	6
Min. cycle time PLCopen part 4: Coordinated Motion						
4 axes	t	[ms]	1	1	1	1
8 axes	t	[ms]	2	2	1	2
16 axes	t	[ms]	3	3	2	3



Handling, commissioning and diagnostics

The Controller-based Automation solution can be easily commissioned and optimised with the PLC Designer and »EASY Starter« engineering tools.

The entire plant is commissioned via the Ethernet terminal of the Controller. By this means, the entire plant will be made available. When the plant is used for the first time, it can be subsequently optimised using the »EASY Starter«.

Drafting concepts



Finding the right solution together

- Individual consulting service by the Lenze field service.
- Joint analysis and definition of the machine topology.
- Basic functions of the FAST modules as basis.
- Consistent automation and drive solution.

Implementing solutions



Consistent engineering using the »PLC Designer«

- Control and drive application with only one tool.
- Creating an application easily using the FAST modules.
- All Lenze motor data is available.
- The oscilloscope function within the inverter supports the assessment and optimisation of the settings.

Manufacturing machines



Commissioning via USB stick

- The prepared USB stick provides for the
 - transfer of the control software.
 - parameter setting and firmware download for connected field devices.
- The complete machine can be prepared, configured and parameterised in an automated fashion.
- Plug in USB stick, start machine, wait, finished.

Ensuring productivity



Easy diagnostics - »EASY Starter«

- Support by the service technicians in commissioning and maintenance.
- Easy parameter setting and commissioning.
- Online diagnostics without the risk of an accidental application change.

Device exchange without tools

- Thanks to automated firmware and parameter download.
- The SD card of the Controller provides for an easier device exchange.
- Possible without any specific know how and software.
- No data of the machine gets lost.

Controls

Visualisation

Industrial PC v800
Monitor v200
VisiWinNET®



Visualisation

Contents



General information

Product key	3.1-4
Features	3.1-5
Product information	3.1-6

Technical data

Standards and operating conditions	3.1-8
Rated data v800 and v200- Protec	3.3-9
Rated data v800 and v200-Cabinet	3.1-10

Accessories

DBaseT Extender kit	3.1-12
T-Adapter	3.1-13
T-Adapter with switch box	3.1-13

Visualisation software

VisiWinNET® Smart	3.1-14
VisiWinNET® Smart development system	3.1-15
VisiWinNET® Runtime licences	3.1-15

Visualisation

General information



Product key

v200 and v800, 2nd generation

	V80	G	B	S	J	7	5	0	H	4	R	XXXX	-00009000000
Device series													
V20 - Monitor													
V80 - Industrial PC													
Version													
S - Protec (industrial PC)													
D - Protec (monitor)													
P - Cabinet (industrial PC)													
M - Cabinet (monitor)													
Screen diagonal/resolution													
J - 43.9 cm (17.3")													
L - 61.0 cm (24")													
USB IP65 on rear (Protec only)													
0 - Without													
5 - 1x USB													
Processor type													
0 - Without (monitor)													
H - Mobile Intel Celeron 1.6 GHz													
K - Mobile Intel Core i5 1.9 (max.2.9) GHz													
Main memory													
0 - Without (monitor)													
6 - 4 GB (Celeron only)													
7 - 8 GB (i5 only)													
Mass storage													
0 - Without (monitor)													
R - Solid State Disk (SSD) 120GB													
Operating system													
0 - Without (monitor)													
9 - Windows Embedded Standard 7 P 64 Bit													

v200 and v800, 1st generation

	V80	G	A	P	G	7	0	0	G	6	R	XXXX	-00009000000
Device series													
V80 - Panel PC													
Version													
P - Cabinet (panel PC)													
Screen diagonal/resolution													
G - 33.8 cm (13.3")													
H - 39.1 cm (15.4")													
K - 54.6 cm (21.5")													
Processor type													
G - Intel® Celeron 1.5 GHz													
J - Intel® Core i5 2.7 (max. 3.3) GHz													
Main memory													
6 - 4 GB													
Mass storage													
R - Solid State Disk (SSD) 120GB													
Operating system													
9 - Windows Embedded Standard 7 P 64 Bit													

Visualisation

Features



Features

The v800 visualisations are compact and designed with a high degree of protection. The connections are protected and integrated into the housing.



v800-Protoc front view with switch box



Rear view with support arm

Visualisation

General information



Product information

Visualisation solutions with the industrial PC v800

Machine visualisations with the v800 industrial PCs can be easily scaled and realised in an optimal manner for the machine. The various screen diagonals and processor capacities are tailored to the requirements of modern machine control. As a stand-alone type (Protec) or embedded panel (Cabinet), they will fit into any machine concept. All devices are equipped with cutting-edge multi-touch glass sensors that can be operated even with gloves on and the operating program can be set up intuitively using the engineering software VisiwinNet.

3.1

The high-quality solution – v800-protec

An appealing, elegant device design with IP65 degree of protection and a shape that ensures ease of cleaning results in a product that offers simple elegance with maximum functionality and the best possible platform for demanding user interface concepts. A high degree of standardisation guarantees maximum availability and protection of software investments over a long period of time.

The highlights

- High-resolution full HD displays in 17.3" and 24.0"
- Maintenance-free thanks to no rotary components
- IPC type with low-power Intel Mobile processors
- Complies with hygienic design guidelines, no visible screws, IP65 degree of protection
- Individualisation via optional switch box

High-quality, integrated into machine housing – v800-Cabinet

The Cabinet version is intended for installation in machine housing. With the same technical specifications as the v800-Protec, this version is an equivalent alternative. The frameless design with narrow edge ensures a streamlined and visually appealing integration thanks to the circumferential seal on the multi-touch glass pane.

The highlights

- High-resolution full HD displays in 17.3" and 24.0"
- Maintenance-free thanks to no rotary components
- IPC type with low-power Intel Mobile processors
- Complies with hygienic design guidelines, no chamfering, front panel, IP65 degree of protection

The high-performance industrial PC – the v800-Cabinet

The devices in this range are ideal for applications that require even more power. The front panels meet the high demands regarding the degree of protection. The innovative cooling method comprising aluminium housing on the rear and durable fans guarantee optimal heat dissipation while ensuring maximum performance.

The highlights

- High-resolution displays in 13.3", 15.4" and 21.5"
- Solid-state disk
- IPC with high-performance industrial Intel processors
- Fan cooled for maximum performance, easily swappable
- Front panel IP65 degree of protection



Visualisation

General information



Product information

Visualisation solutions with monitor

The v200 monitors depict the visualisation created on the upstream IPC. All the required functions are transferred to the monitors and scaled to suit the features of the v800 industrial PC family. A visually uniform line from the industrial PC to the monitor enables uniform machine design. They are available both as embedded panel (Cabinet) or as stand-alone (Protec) versions. All devices are equipped with cutting-edge multi-touch glass sensors that can be operated even when wearing gloves.

The modern monitor – v200-Protec

An appealing, elegant device design with IP65 degree of protection and an easy-to-clean design results in sleek elegance with maximum functionality and the best possible platform for demanding user interface concepts. A high degree of standardisation guarantees maximum availability and protection of investments over a long period of time.

The highlights

- High-resolution full HD displays in 17.3" and 24.0"
- Standard HDMI or DisplayPort connection
- Optional mounting up to 100 m from control cabinet PC via integrable Extender
- Complies with hygienic design guidelines, no visible screws, IP65 degree of protection

Modern integrable monitor – v200-Cabinet

Designed for direct installation into machine housing, these devices offer an alternative platform as they have the same technical specifications and options as the v200-p series. The frameless design with narrow edge ensures a streamlined and visually appealing integration thanks to the circumferential seal on the multi-touch glass pane.

The highlights

- High-resolution full HD displays in 17.3" and 24.0"
- Standard HDMI or display port connection
- Optional installation up to 100 m from control cabinet PC via integrable Extender
- Complies with hygienic design guidelines, no chamfering, IP65 degree of protection on front panel



Visualisation

Technical data



Standards and operating conditions

Type	Protec	Cabinet
Conformity	CE	
RoHS	2011/65/EU	
EN50581	2011/65/EU	
Degree of protection	IP65	IP65 on front IP20 on rear
Vibration resistance	3M4	
Vibration (IEC/EN 60721-3-3)	3M4	3M5
Shock (IEC/EN 60721-3-3)	3M4	3M5
Climatic conditions	-20 °C – 60 °C, 10% - 85% air humidity without condensation	
Storage (IEC/EN 60068-2-1)	-20 °C – 60 °C, 10% - 85% air humidity without condensation	-20 °C – 60 °C, 10% - 85% air humidity without condensation
Transport (IEC/EN 60068-2-2)	-20 °C – 60 °C, 10% - 85% air humidity without condensation	-20 °C – 60 °C, 10% - 85% air humidity without condensation
Operation (IEC/EN 60068-2-14)		
13.3 "		0 °C – 55 °C, 10% - 85% air humidity without condensation
15.4 "		0 °C – 55 °C, 10% - 85% air humidity without condensation
17 "	0 °C – 55 °C, 10% - 85% air humidity without condensation	0 °C – 55 °C, 10% - 85% air humidity without condensation
21.5 "		5 °C – 45 °C, 10% - 85% air humidity without condensation
24 "	0 °C – 45 °C, 10% - 85% air humidity without condensation	0 °C – 45 °C, 10% - 85% air humidity without condensation
Site altitude	< 12000 m amsl	
Transport	< 12000 m amsl	< 12000 m amsl
	< 3000 m amsl	< 3000 m amsl
Degree of pollution	2	
IEC/EN 61131-2	2	2

3.1

Visualisation

Technical data



Rated data v800 and v200-Protoc

Version			v800-P				v200-P	
Screen diagonal			43.9 cm (17.3")	61 cm (24")	43.9 cm (17.3")	61 cm (24")	43.9 cm (17.3")	61 cm (24")
Resolution		Pixel	1920 x 1080		1920 x 1080		1920 x 1080	
Touch			Capacitive glass surface, Multi-Touch		Capacitive glass surface, Multi-Touch		Capacitive glass surface, Multi-Touch	
Processor type			Intel® Celeron® Processor 2980U (2M Cache, 1.60 GHz)		Intel® Core™ i5-4300U Processor (3M Cache, 1.90 up to 2.90 GHz)			
Graphics processor			Intel® HD Graphics		Intel® HD Graphics 4400			
Operating system			Windows Embedded Standard 7 P 64 Bit		Windows Embedded Standard 7 P 64 Bit			
Storage medium								
Mass storage		[GB]	120 (2.5" SSD)		120 (2.5" SSD)			
Internal memory		[GB]	4		8			
Interfaces								
USB host 3.0/2.0 1x external access point			2 / 1		2 / 1		-	/2
USB Device 2.0			2		2		1	
Ethernet (10/100/1000 Mbit/s)			2		2			
HDMI / display port							1/1	
Rated voltage DC	U _{N, DC}	[V]	24 (+/- 20%)		24 (+/- 20%)		24 (+/- 20%)	
Max. current consumption (incl. USB)	I	[A]	3	4	3	4	2	2
Maximum starting current	I	[A]	4	4	4	4	3	3
Fusing of supply voltage	I	[A]	4 slow-blow	6 slow-blow	4 slow-blow	6 slow-blow	4 slow-blow	4 slow-blow
Weight	m	[kg]	4.8	7.7	4.8	7.7	4.6	7.5
Dimensions incl. switch box	Wx-HxD	[mm]	431x351x216	578x436x216	431x351x216	578x436x216	431x351x216	578x436x216
Dimensions without switch box	Wx-HxD	[mm]	431x261x216	578x347x216	431x261x216	578x347x216	431x261x216	578x347x216

3.1

Visualisation

Technical data



Rated data v800 and v200-Cabinet, 2nd generation

								
Version			v800-C				v200-C	
Screen diagonal			43.9 cm (17.3")	61 cm (24")	43.9 cm (17.3")	61 cm (24")	43.9 cm (17.3")	61 cm (24")
Resolution		Pixel	1920 x 1080		1920 x 1080		1920 x 1080	
Touch			capacitive glass surface, Multi-Touch		capacitive glass surface, Multi-Touch		capacitive glass surface, Multi-Touch	
Processor type			Intel® Celeron® Processor 2980U (2M Cache, 1.60 GHz)		Intel® Core™ i5-4300U Processor (3M Cache, 1.90 up to 2.90 GHz)			
Graphics processor			Intel® HD Graphics		Intel® HD Graphics 4400			
Operating system			Windows Embedded Standard 7 P 64 Bit		Windows Embedded Standard 7 P 64 Bit			
Storage medium								
Mass storage		[GB]	120 (2.5" SSD)		120 (2.5" SSD)			
Internal memory		[GB]	4		8			
Interfaces								
USB host 3.0/2.0 1x external access point			2 / 1		2 / 1		-	/2
USB Device 2.0			2		2		1	
Ethernet (10/100/1000 Mbit/s)			2		2			
HDMI / DisplayPort							1/1	
Rated voltage DC	U _{N, DC}	[V]	24 (+/- 20%)		24 (+/- 20%)		24 (+/- 20%)	
Max. current consumption (incl. USB)	I	[A]	3	4	3	4	2	2
Maximum starting current	I	[A]	4	4	4	4	3	3
Fusing of supply voltage	I	[A]	4 slow-blow	6 slow-blow	4 slow-blow	6 slow-blow	4 slow-blow	4 slow-blow
Dimension	Wx- HxD	[mm]	433x263x 89	580x349x 89	433x263x 89	580x349x 89	433x263x 89	580x349x 89
Mounting depth	D	[mm]	79	79	79	79	62	62
Mounting cutout	WxH	[mm]	422x252	569x338	422x252	569x338	422x252	569x338

3.1

Visualisation

Technical data



Rated data v800-Cabinet, 1st generation

								
Version			v800-C					
Screen diagonal			33.8 cm (13.3")	39.1 cm (15.4")	54.6 cm (21.5")	33.8 cm (13.3")	39.1 cm (15.4")	54.6 cm (21.5")
Resolution			1280 x 800	1280 x 800	1920 x 1080	1280 x 800	1280 x 800	1920 x 1080
Touch			capacitive glass surface, Multi-Touch			capacitive glass surface, Multi-Touch		
Processor type			Intel® Celeron® Processor 2002E (2M Cache, 1.50 GHz)			Intel® Core™ i5-4400E Processor (3M Cache, 2.70 up to 3.30 GHz)		
Graphics processor			Intel® HD Graphics			Intel® HD Graphics 4600		
Operating system			Windows® Embedded Standard 7 P 64 bit			Windows® Embedded Standard 7 P 64 bit		
Storage medium								
Mass storage		[GB]	120 (2.5" SSD)			120 (2.5" SSD)		
Internal memory		[GB]	4			8		
Interfaces								
COM (RS232)			1			1		
USB Device 2.0			2/2 on rear			2/2 on rear		
Ethernet (10/100/1000 Mbit/s)			3			3		
Rated voltage DC	U _{N, DC}	[V]	24 (+/- 20%)		24 (+/- 20%)		24 (+/- 20%)	
Max. current consumption (incl. USB)	I	[A]	3	4	3	4	3	4
Maximum starting current	I	[A]	8	8	8	8	8	8
Fusing of supply voltage	I	[A]	4 slow-blow	4 slow-blow	4 slow-blow	4 slow-blow	6 slow-blow	6 slow-blow
Weight	m	[kg]	3.6	4.9	8.6	3.6	4.9	8.6
Dimension	Wx- HxD	[mm]	353 x 261 x 63	426 x 261 x 66	567 x 369 x 66	353 x 261 x 63	426 x 261 x 66	567 x 369 x 66
Mounting depth	D	[mm]	51	54	54	51	54	54
Mounting cutout	WxH	[mm]	332 x 240	392 x 269	532 x 334	332x240	392 x 269	532 x 334

3.1

Visualisation

Accessories



DBaseT Extender kit

The HDBaseT Extender can be optionally retrofitted to the monitors v200-C and v200 –P. This expansion in the form of a transmitter and receiver module enables digital image and USB 2.0 signals to be transferred up to 100 m via a network cable using the HDBaseT standard.

Transmission of DisplayPort / HDMI / DVI video and USB (2.0) signal

- Transmission length: max. 100 m
- Easy installation: plug and play, no software driver required
- Easy installation: TX module on DIN rail, RX module is inserted into module slot on the rear of the monitor

3.1

Version	Characteristics	Product key
HD BaseT Extender kit	HDBase-T transmitter (TX) <ul style="list-style-type: none"> • Control cabinet mounting via DIN rail • 1 x HD Base-T transmitter (TX) • 1 x DisplayPort > HDMI cable (100 cm) • 1 x USB host > USB slave cable (100 cm) • 1 x 24 VDC connector 	EPCZEBE1
	HDBase-T receiver (RX) <ul style="list-style-type: none"> • Snap-in installation slot in monitor • 1 x HD Base-T receiver (RX) • 1 x HDMI > HDMI cable (25cm) • 1 x USB host > USB slave cable (10 cm) • 1 x 24 VDC supply cable (10 cm) • 1 x 24 VDC connector 	

Transmission cable for HDBaseT Extender

The following CAT cables are recommended for operation:

- CAT6a cable, maximum cable length up to 80 m, 24AWG/27AWG, shielded
- CAT7 cable, maximum cable length up to 100 m, 24AWG, shielded

Transmission cable for v200 monitor

A Display Port (DP) or HDMI cable and USB cable can be used to connect the v200 monitors:

Version	Characteristics	Product key
DP/DP cable	• Length: 3 m for connection via DisplayPort	EWL0091
	• Length: 5 m for connection via DisplayPort	EWL0092
HDMI/HDMI cable	• Length: 3 m for video connection via HDMI	EWL0093
	• Length: 5 m for video connection via HDMI	EWL0094
USB (host/slave)	• Length: 3 m for touch and external devices on monitor	EWL0095
	• Length: 5 m for touch and external devices on monitor	EWL0096

Visualisation

Accessories



T-Adapter

The support arm is required to mount the v800-Protoc and v200-Protoc on a standard 48 mm stainless steel tube. It has an integrated tilting device to tilt the display unit and can be rotated +/- 90° using the quick release clamping screw. This type is designed for use in support arm constructions with the IP65 degree of protection. The support arm adapter is supplied in series for hanging mounting but can be adapted for vertical mounting in just a few steps.



T-Adapter with switch box

The switch box is designed to expand the T-Adapter with standard 22 mm command elements. Like the console, the switch box has a screwless design. Thanks to easy removal of the front unit and by tearing the perforated installation opening, up to seven standard command elements (e.g. for 6 pushbuttons and 1x emergency-off switch) can be fitted. The labelling on the command elements can be individualised using slide-in strips.



3.1

Version	Characteristics	Product key
T-Adapter	<ul style="list-style-type: none"> • Mounting on 48 mm tube, either hanging or vertical 	EPCZMP1
T-Adapter 17" with switch box	<ul style="list-style-type: none"> • Mounting on 48 mm tube, either hanging or vertical • 7x command elements • The switch box is prepared for the recording of standard 22.5-mm command elements. • Standard pushbuttons and switches can be installed. • The command elements are not included in the scope of supply. 	EPCZEBT801-000
T-Adapter 24" with switch box	<ul style="list-style-type: none"> • Mounting on 48 mm tube, either hanging or vertical • 7x command elements • The switch box is prepared for the recording of standard 22.5-mm command elements. • Standard pushbuttons and switches can be installed. • The command elements are not included in the scope of supply. 	EPCZEBT901-000
Tool for T-Adapter mounting	<ul style="list-style-type: none"> • Rotates the mounting tube 180°. 	EPCZMB5



VisiWinNET® Smart

Machines are almost exclusively equipped with visual operating units. Creating a machine visualisation used to be a subtask of control programming, but today it has developed into a core autonomous discipline. Interfaces that were often technically overloaded and could only be operated by experts have given way to user-oriented visual machine operation and have therefore become an important sales argument. VisiWinNET® Smart is the ideal tool for this task.

3.1

Advantages of visualisation software:

- Intuitive project planning:
the integrated development environment of VisiWinNET Smart offers all functions under one roof. The graphics designer for visualisation pages and all other editors and tools are grouped into a flexible, modern window layout with dockable elements that also enables the use of multiple monitors.
- Intelligent data exchange
Project data such as variables, texts or alarms can easily be exchanged with other programs. The transfer of variables directly from the control project goes hand-in-hand with easy exchange of data with Microsoft Excel using the Windows clipboard.
- Parallel installation
Various VisiWinNET versions can be installed alongside one another on one computer. New projects can always be developed using the latest version and older ones are supported.
- Modern software architecture
VisiWinNET® SMART comprises a development system with a full-graphics integrated development environment and a runtime licence scalable to the scope of the project. For the v800 industrial PCs, single user and client server solutions can be realised with the standard framework.
- ... and if you need a bit more:
For tasks that go beyond the scope of VisiWinNET® Smart, it is possible to expand the software to suit your individual needs with the expert tools VisiWinNET® Professional. If you require this, please get in touch with your Lenze contact person. We would be happy to make you an offer for a solution that meets your needs.

VisiWinNET® Smart main components:

- Process communication for technical process monitoring
- Language options for international use
- Alarm management, data logging and trend recording for plant controlling
- Recipe management and user management

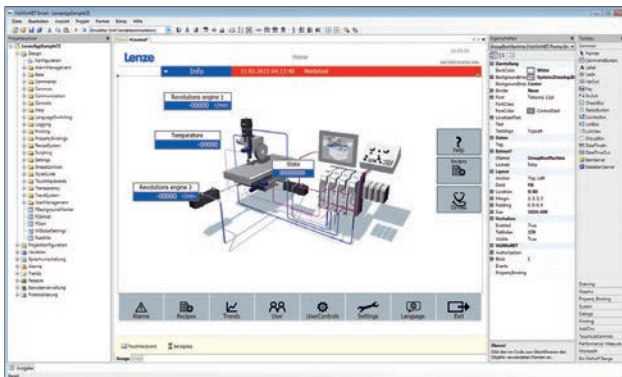

Visualisation

Visualisation software



VisiWinNET® Smart development system

The integrated development environment of VisiWinNET® SMART is offered in the form of single user and client/server applications for the creation of visualisations. Please specify the respective option when ordering the engineering software.

Version	Development system	Target system	Product key
VisiWinNET® SMART	<ul style="list-style-type: none"> • Single user licence • Operating system engineering software: Windows® 7, Windows® 8 • Licencing: USB dongle 	<ul style="list-style-type: none"> • Single user licence Windows® 7, Windows® 8 	7710120065
	<ul style="list-style-type: none"> • Single user licence • Operating system engineering software: Windows® 7, Windows® 8 • Licencing: USB dongle 	<ul style="list-style-type: none"> • Client/Server Windows® 7, Windows® 8 	7710130065
	<ul style="list-style-type: none"> • Upgrade 	Single user licence on client/server	7710131065
VisiWinNET® Professional			On request

3.1

VisiWinNET® Runtime licences

To realise your machine visualisation developed with VisiWinNET® Smart, your Lenze industrial PC requires the respective VisiWinNet® Runtime. The number of power tags, i.e. the data that needs to be exchanged with the control system, should be selected depending on the scope of the project.

For data exchange in networked environments, the runtime system also has an additional OPC server interface. Via this interface, higher-level systems can access process variables within the visualisation application and exchange relevant data, making connections to e.g. an ERP system or data exchange between multiple machines easier.

Single user licences

Item description			Order code		
VisiWinNET® 250	250 power tags	Windows® 7, Windows® 8	7700	4430	025
VisiWinNET® 500	500 power tags	Windows® 7, Windows® 8	7700	4430	050
VisiWinNET® 1000	1000 power tags	Windows® 7, Windows® 8	7700	4430	100
VisiWinNET® 2000	2000 power tags	Windows® 7, Windows® 8	7700	4430	200
VisiWinNET® 4000	4000 power tags	Windows® 7, Windows® 8	7700	4430	400
VisiWinNET® 64000	64000 power tags	Windows® 7, Windows® 8	7700	4430	999
Licencing		USB dongle Licence file with mandatory hardware			5 6

Client/server licences

Item description			Order code		
VisiWinNET® 250	250 power tags	Windows® 7, Windows® 8	7700	4440	025
VisiWinNET® 500	500 power tags	Windows® 7, Windows® 8	7700	4440	050
VisiWinNET® 1000	1000 power tags	Windows® 7, Windows® 8	7700	4440	100
VisiWinNET® 2000	2000 power tags	Windows® 7, Windows® 8	7700	4440	200
VisiWinNET® 4000	4000 power tags	Windows® 7, Windows® 8	7700	4440	400
VisiWinNET® 64000	64000 power tags	Windows® 7, Windows® 8	7700	4440	999
VisiWinNET® Client	Operate and monitor (client)	Windows® 7, Windows® 8	7700	4440	001
VisiWinNET® Viewer	Monitor (viewer)	Windows® 7, Windows® 8	7700	4440	002
Licencing		USB dongle Licence file with mandatory hardware			5 6

Controller 3200 C



Controller 3200 C

Contents



General information	Product key	3.3 - 4
	Equipment	3.3 - 5
	Product information	3.3 - 6
	Lenze FAST	3.3 - 8
Technical data	Standards and operating conditions	3.3 - 10
	Rated data	3.3 - 11
	Dimensions	3.3 - 12
Interfaces	Connection plan	3.3 - 13
	Mains connection	3.3 - 13
Accessories	Safety Controller	3.3 - 14
	Application Credit	3.3 - 15
	SD card and USB flash drive	3.3 - 19
	24 V power supply unit	3.3 - 19
	CAN bus connector	3.3 - 20
MC cards	3.3 - 20	

Controller 3200 C

General information



Product key

Product

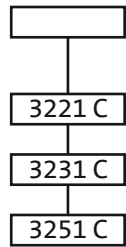

Product key

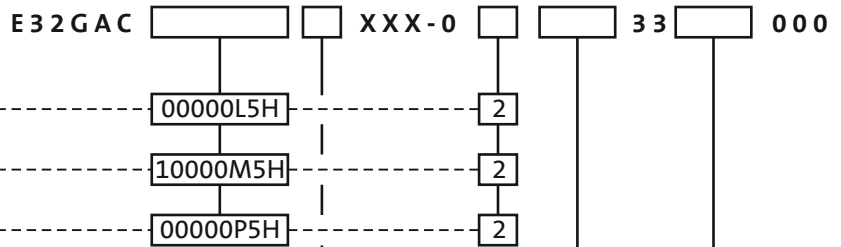

Option interface MC 1

- 0 – No
- 5 – MC-PBM (PROFIBUS Master)
- 6 – MC-PBS (PROFIBUS Slave)
- 8 – MC-PND (PROFINET Device)
- 9 – MC-CAN2 (CANopen)

Application Credit

- | | |
|------------------------------|------------------------------|
| S1 - Application Credit 0 | AA - Application Credit 1200 |
| A1 - Application Credit 100 | AB - Application Credit 1500 |
| A2 - Application Credit 150 | AC - Application Credit 2000 |
| A3 - Application Credit 200 | AD - Application Credit 2500 |
| A4 - Application Credit 300 | AE - Application Credit 3000 |
| A5 - Application Credit 400 | AF - Application Credit 4000 |
| A6 - Application Credit 500 | |
| A7 - Application Credit 600 | |
| A8 - Application Credit 700 | |
| A9 - Application Credit 1000 | |

Runtime Software visualisation (3231 C only)

- 00 – Visu: without runtime
- 14 – Visu: VisiWinNET® Compact CE, 500 power tags

3.3



Controller 3221 C and 3251 C



Controller 3231 C

Controller 3200 C

General information



Equipment

USB 3

Touchscreen connection
(not with 3221 C, 3251 C)

LAN 1a

Ethernet 10/100 MBits/s
with integrated switch

LAN 1b

Ethernet 10/100 MBits/s
with integrated switch

EtherCAT

DVI-D

External monitor connection
(not with 3221 C, 3251 C)

Supply voltage

24V DC

Option interface

Bus system extensions

4 LEDs

Status display

Supply module

Supply for stacked I/O modules

I/O system 1000

Up to 64 modules
Analog and digital
inputs and outputs

SD card

Data memory for project data
Accessories: application credit

USB 1

Keyboard connection (optional)

USB 2

USB stick connection
for backup (optional)



3.3

Safety topology extension

Safety-Controller c250-Sx

Safety-bus coupler

Unlocking mechanism

Status-LEDs

Network Out

Network In

24-V-connection

Additional shield connection

Safety-I/O-Modul

E-Bus

(covered)

Status-LEDs

Terminal strip

IO-LEDs

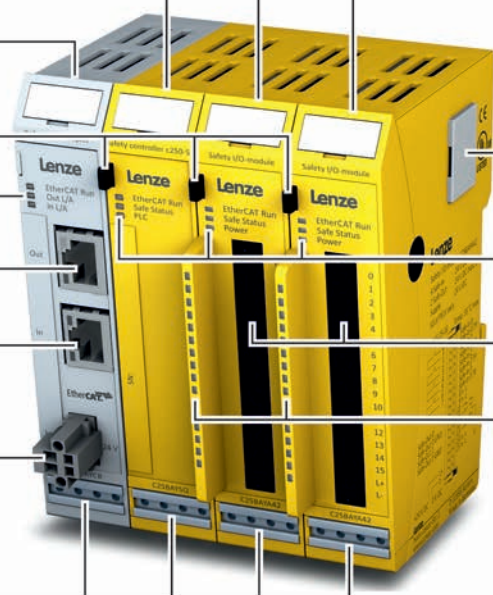

Controller 3200 C

General information



Product information

The Controller 3200 C is the ideal platform for automation systems in the control cabinet. It is based on the Intel® processor Atom™, which makes it possible to implement a powerful computer architecture without force-cooling and other moving components even in the smallest of spaces. As a special touch it is possible to directly attach the I/O system 1000 without taking the detour via fieldbuses.

Variants

The Controller 3200 C comprises three versions. Together with our system modules, the variants 3221 C, 3231 C and 3251 C provide the basis for a powerful Motion controller – with and without an integrated visualisation! The controller version 3231 C is provided with an integrated DVI interface to which external monitors or monitor panels can be connected.



Integrated Ethernet switch

The integrated switch allows line topologies to be established using Ethernet without the need for a separate switch as an infrastructure component. In addition to this, a free interface provides allows a diagnostics device such as a service technician's laptop to be connected without having to access the bus physics.

I/O System 1000 as local I/Os

The extremely fast communication (48 Mbps) between the L-force Controller 3200 C and the I/O modules takes place via a proprietary, yet extremely efficient backplane bus. This allows individual and group access to the inputs and outputs and also enables precise synchronisation of the input modules, which attach a time stamp to the input signals with a resolution of 1µs and thereby ensure high-precision.

Safety topology with EtherCAT®

The Safety Controller c250-S clears the way for planning the complete drive and safety technology from one single source. The entire machine safety can be programmed with only one engineering tool, based on the PLCOpen standard - irrespective whether it is about "grey" or "yellow" control technology.

The deep integration of the functional safety into the automation system makes the engineering easier, improves the diagnostics options and reduces the number of interfaces and components. This saves time and money and finally increases the availability and flexibility of the machine.

Controller 3200 C

General information



Product information



Logic (PLC), motion and visualisation in a single device

- Optimised for machine(modules) with central motion control
- Easy engineering thanks to central data storage



Easy to use

- Easy use of FAST via pluggable SD card with Application Credit for Motion Control or Coordinated Motion
- Automated standard set-up and data backup via USB stick
- Easy device replacement by means of the pluggable SD card with the corresponding Application Credit
- Diagnostics by implemented web server or EASY Starter



Communicative

- EtherCAT® as a fast bus system directly on board (in preparation)
- CANopen on board
- Precisely tailored by modular extension option



High-precision control for optimum manufacturing results

- Touch probe-compatible inputs
- High-precision output control
- Highly deterministic backplane bus with precise 1 µs time stamp

IEC 61131-3



Prepared for the future thanks to compliance with industrial standards

- Programming in IEC61131-3
- Motion Control as per PLCopen
- PLC Designer based on CODESYS3



I/O system 1000 as local I/Os

- Permanent wiring due to separation of electronics and base module
- Fast diagnostics achieved thanks to clear labelling of the LEDs assigned to each channel
- Easy connection thanks to inclusion of printed circuit diagram
- Fully integrated shield connection without special shield terminals

Controller 3200 C

General information



Lenze FAST

Lenze FAST (Feasibly Applicable Software Toolbox) provides Lenze standard software modules for easily developing a modular machine control.

FAST Motion functions serve to implement individual extensions. The »EASY Starter« can be used to subsequently optimise and diagnose the system.

For this purpose, the »PLC Designer« engineering tool with the "FAST Application Template" provides for an easy programming and commissioning as standardised software structure and with predefined technology modules.

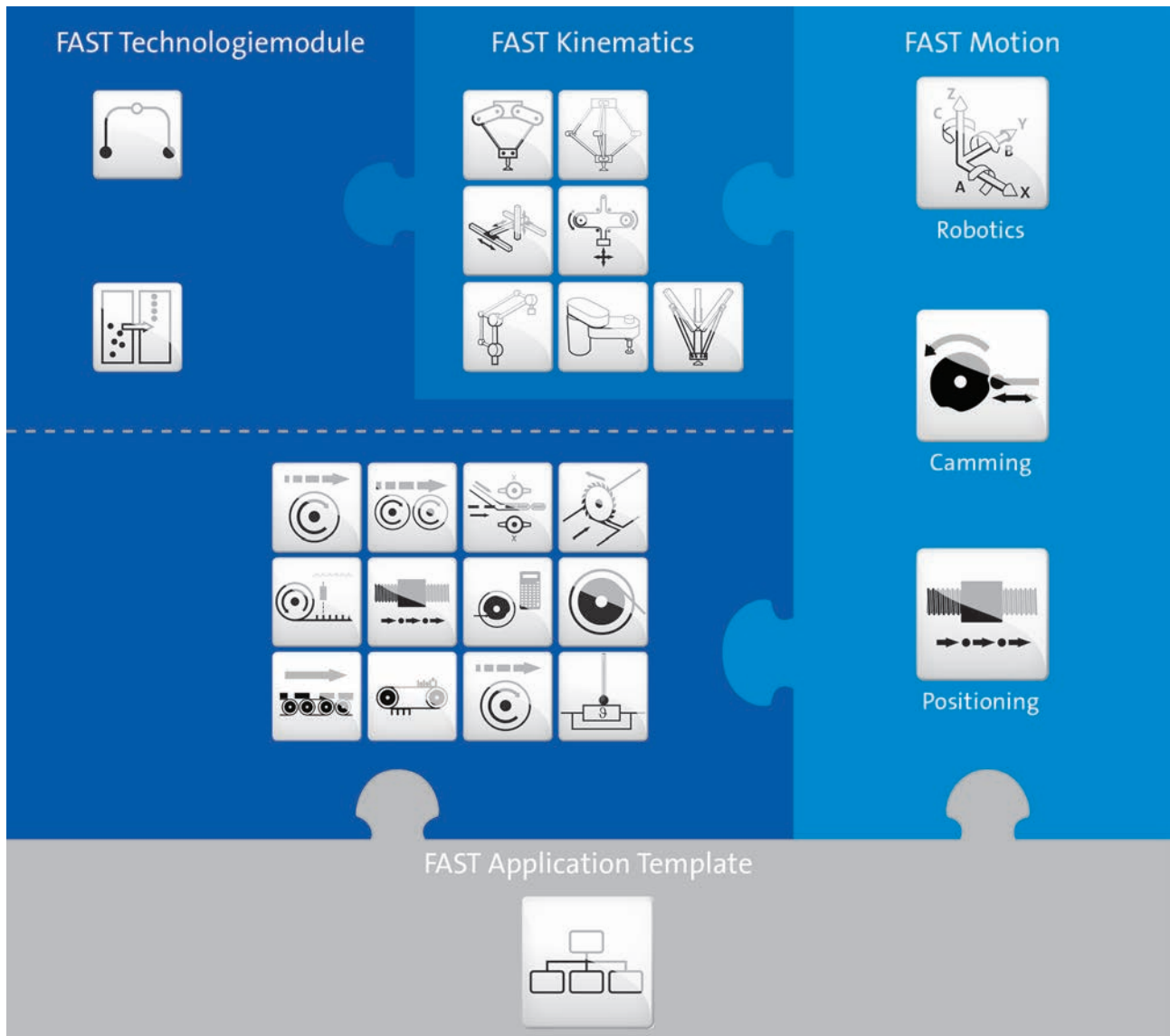

3.3

FAST Application Template

The FAST Application Template is standardised by Lenze for a modularised and clear programming in the »PLC Designer«.

The FAST Application Template can be used via a library in the »PLC Designer«. The library contains the structure and basic functionality of the FAST Application Template (as, for instance, state machine and error handling).

Controller 3200 C

General information



Lenze FAST

FAST technology modules

The predefined FAST technology modules serve to easily implement the desired machine functions.

The FAST technology modules are standardised software modules for a modular programming of the machine control. A FAST technology module features a complete and pre-tested drive function. Integrated basic functions and an integrated visualisation provide for an easy commissioning and testing of the modules. The reusability of the modules increases the quality of the software and considerably reduces the time required for programming, commissioning and testing.

FAST Motion

FAST Motion provides full flexibility and scalability for machine programming and comprises optimised function blocks based on "PLCopen motion control":

- "Motion Control" modules (based on PLCopen Motion Control (formerly part 1+2) are optimised for the basic functions "positioning" and "cams" (synchronising).
- "Coordinated Motion" modules (based on PLCopen Coordinated Motion (part 4) are optimised for multi-axis coordinated three-dimensional movements – which can also be controlled via the FAST technology modules "Pick & Place".

The FAST technology modules are contained in the »PLC Designer« as independent function blocks in a library. They use the standardised interfaces and can thus be easily integrated into the machine program, combined in any way and extended individually with FAST Motion functions.

If the functionalities of the FAST technology modules are not sufficient, they can be adapted and extended individually using the FAST Motion modules. These modules are capable to program any number of functions.

The »PLC Designer« contains the "Motion Control" modules in two libraries and the "Coordinated Motion" modules in one library.

Controller 3200 C

Technical data



Standards and operating conditions

Mode			3221 C	3231 C	3251 C
Controller					
Conformity					
CE			Low-Voltage Directive		
			2014/30/EU		
EAC			TP TC 020/2011 (TR CU 020/2011)		
Approval					
UL 508C			Process Control Equipment (File-No. E236341)		
UL/CSA			CSA 22.2 No.142		
Degree of protection					
EN 60529			IP20		
NEMA 250			Type 1		
Climatic conditions					
Storage (EN 60721-3-1)			1K3 (Temperature: -5 °C ... +45 °C)		
Transport (EN 60721-3-2)			2K3 (temperature: -25 °C ... +70 °C)		
Operation (EN 60721-3-3)			3K3 (temperature: 0 °C ... +55 °C) ¹⁾ 3K3 (temperature: 0 °C ... +50 °C) ²⁾	3K3 (temperature: 0 °C ... +50 °C) ¹⁾ 3K3 (temperature: 0 °C ... +45 °C) ²⁾	
Degree of pollution					
EN 61131-2			2		
Site altitude					
Amsl	H _{max}	[m]	3000		
Vibration resistance					
Vibration (EN 61131-2)			1 g		
Mechanical shock (EN 61131-2)			15 g		
Operation (Germanischer Lloyd)			5 Hz ≤ f ≤ 13.2 Hz: ± 1 mm amplitude 13.2 Hz ≤ f ≤ 100 Hz: 0.7 g		
Noise emission					
EN 61000-6-4			Industrial premises		
Noise immunity					
EN 61000-4-2			ESD: Severity 3		
EN 61000-4-6			150 kHz ... 80 MHz, 10 V/m 80 % AM (1 kHz)		
EN 61000-4-3			80 kHz ... 1000 MHz, 10 V/m 80 % AM (1 kHz) 1.4 GHz ... 2.0 GHz, 3 V/m, 80 % AM (1kHz) 2.0 GHz ... 2.7 GHz, 1 V/m, 80 % AM (1kHz)		
EN 61000-4-4			Burst: Severity 3		

¹⁾ Horizontal mounting



²⁾ Vertical mounting

Controller 3200 C

Technical data



Rated data

					
Mode			3221 C	3231 C	3251 C
Controller			3221 C	3231 C	3251 C
Processor type			Intel® Atom™ 1.46 GHz		
Fanless			Intel® Atom™ 1.46 GHz	Intel® Atom™ 1.75 GHz	Intel® Atom™ 1.91 GHz
Storage medium					
SD card ¹⁾		[MB]	512		
Interfaces					
Ethernet (integrated switch)			2		
EtherCAT Master			1		
USB			2	3	2
DVI-D			1		
Option			Interface connection for CANopen (MC-CAN2) Interface connection for PROFIBUS Master (MC-PBM) Interface connection for PROFIBUS Slave (MC-PBS) Interface connection for PROFINET-Device (MC-PND) Interface connection for EtherNet (MC-ETH) Interface connection for RS232, 422, 485 (MC-ISI)		
Rated voltage					
DC	$U_{N,DC}$	[V]	24		
Max. current consumption					
With connected I/Os	I_{max}	[A]	1.00	1.20	
Without connected I/Os	I_{max}	[A]	0.60	0.80	
Operating system			Windows® CE 6.0		
Memory size					
Program memory		[MB]	512		
Data memory		[MB]	512		
Flags		[kB]	4		
Retain data		[kB]	60		
Main memory (RAM)		[GB]	2		
Min. internal flash memory		[GB]	4		
Runtime					
FAST Runtime			●		
Visualisation ²⁾			●		
Dimensions					
	h x b x t	[mm]	112 x 136 x 105		
Mass					
	m	[kg]	0.70		

3.3

¹⁾ 1 x SD card included in the scope of supply.

²⁾ Controller 3231 C with external monitor at the DVI-D interface. For operation, power tags are required.

Controller 3200 C

Technical data



Dimensions

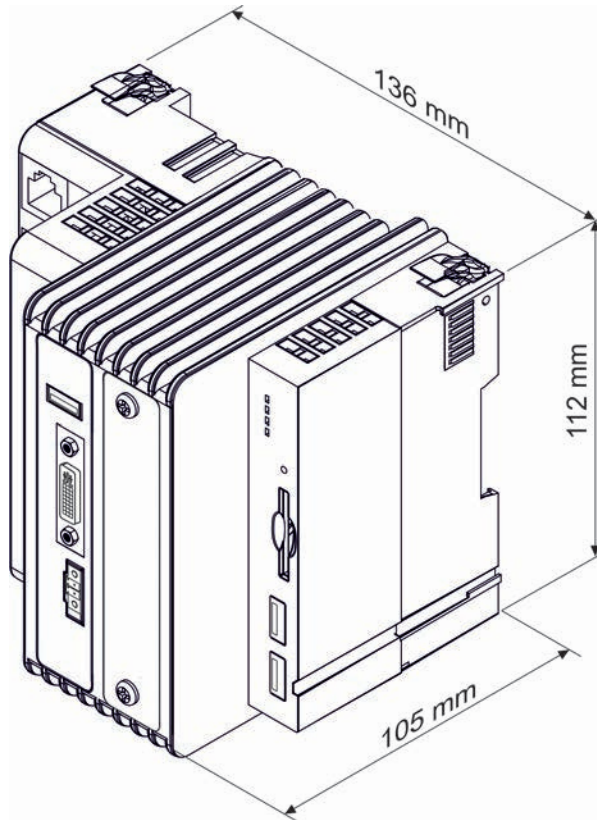

3.3

Controller 3200 C

Interfaces



Connection plan

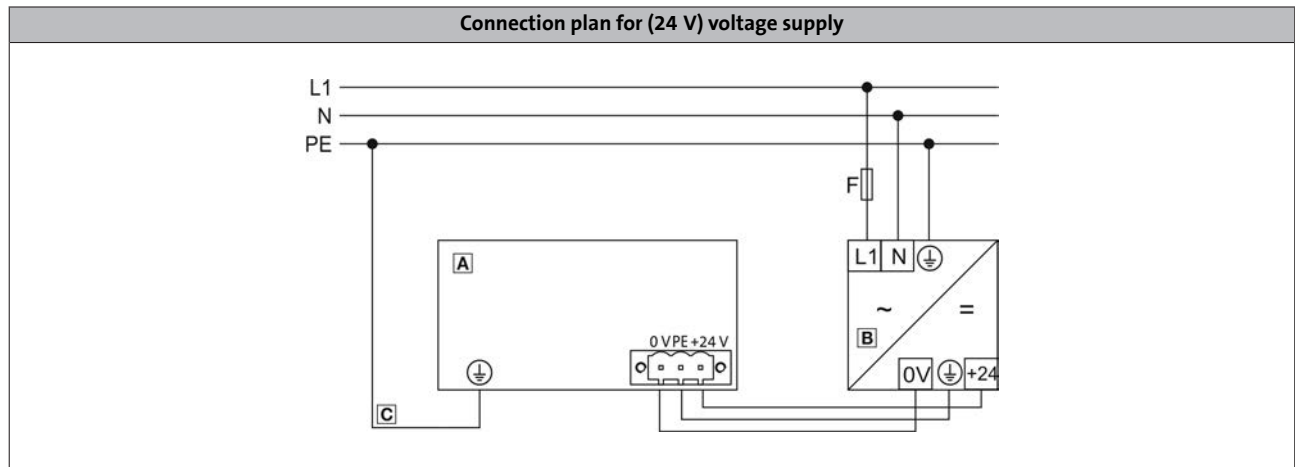

3.3

Position	Meaning
A	Controller
B	Power supply unit
C	Protective earth connection on the supply side via DIN rail

Mains connection

	Connection	Connection type	Cable type
	DC supply (24 V)	3-pole Combicon socket	Cable with Combicon-plug (cable cross-section max. 2.5 mm ²)

Controller 3200 C

Accessories



Safety Controller

Safety in the system does not begin with the drives first, but at the control level.

With the expansion of the controller software to include the Safety Controller c250-S a complete automation solution is provided for safety engineering and control and drive tasks. Topped with the safety I/O module, all the safety aspects in the machine module can be evaluated. EtherCAT is used for data transfer.



3.3

Mode		Features	Product key
Safety Controller c250-S	-	<ul style="list-style-type: none"> Compact Controller c250-S for easy mounting using the DIN rail High-quality safety solution thanks to PL e/SIL 3 	C25BAYSQ
Safety bus coupler	-	<ul style="list-style-type: none"> Supported network: EtherCAT with safety-over EtherCAT (FSoE = Fail Safe over EtherCAT) 	C25BAYCB
Safety I/O module	-	<ul style="list-style-type: none"> Expansion of the Safety Controller with 4 safe inputs and 2 safe outputs 	C25BAYA42

Safety Controller	
Functions	Implementation according to PLCopen, TC 5
Equivalence / antivalence test	SF_Equivalent SF_Antivalent
Operation mode selector	SF_ModeSelector
Emergency stop, emergency off	SF_EmergencyStop
Monitoring of electro-sensitive protective equipment (ESPE)	SF_ESPE (electro-sensitive protective equipment)
Guard monitoring	SF_GuardMonitoring
Guard monitoring with locking	SF_GuardLocking
Two-hand control	SF_TwoHandControlTypeII SF_TwoHandControlTypeIII
Muting	SF_MutingSeq SF_MutingPar SF_MutingPar_2Sensors
Cyclic test of ESPE	SF_TestableSafetySensor
Enable switch	SF_EnableSwitch
Controlling safety output with standard controller and safety controller	SF_OutControl
Monitoring of feedback loop	SF_EDM (external device monitoring)

Technical data	
Rated current	240 mA via E-bus connection
DC supply voltage	5 V via E-bus connection 24 V via safety bus coupler
Dimensions h x w x d	120 mm x 25 mm x 90 mm
Degree of protection	IP20

Controller 3200 C

Accessories



Application Credit

With Lenze FAST, technology modules are provided for Motion Control and Coordinated Motion. In order that these modules are used, the following Application Credit is required. If different technology modules are used, the demand for Application Credit must be added for all modules used.





Mode		Features	Product key
Application Credit		• Licence for use of FAST Application Software, 100 points	EPCZEMSD0L1010
		• Licence for use of FAST Application Software, 150 points	EPCZEMSD0L1015
		• Licence for use of FAST Application Software, 200 points	EPCZEMSD0L1020
		• Licence for use of FAST Application Software, 300 points	EPCZEMSD0L1030
		• Licence for use of FAST Application Software, 400 points	EPCZEMSD0L1040
		• Licence for use of FAST Application Software, 500 points	EPCZEMSD0L1050
		• Licence for use of FAST Application Software, 600 points	EPCZEMSD0L1060
		• Licence for use of FAST Application Software, 700 points	EPCZEMSD0L1070
		• Licence for use of FAST Application Software, 1000 points	EPCZEMSD0L1100
		• Licence for use of FAST Application Software, 1200 points	EPCZEMSD0L1120
		• Licence for use of FAST Application Software, 1500 points	EPCZEMSD0L1150
		• Licence for use of FAST Application Software, 2000 points	EPCZEMSD0L1200
		• Licence for use of FAST Application Software, 2500 points	EPCZEMSD0L1250
		• Licence for use of FAST Application Software, 3000 points	EPCZEMSD0L1300
• Licence for use of FAST Application Software, 4000 points	EPCZEMSD0L1400		

3.3

FAST technology modules



Single drives

Technology module		Function	Points for use
Virtual Master		Implementation of a virtual master axis in the machine	25
Basic Motion		Provides easy basic motion functions: Manual jog, homing, absolute and relative positioning, continuous travel	
Electrical Shaft		Synchronisation and coupling of drives with precise speed and positioning.	
Flex Cam		Implementation of one or several electric cams. Flexible management of curves created online and offline.	50
Cross Cutter		Synchronised movements of drives for cross-sealing and/or cross-cutting of products.	100







Controller 3200 C

Accessories



Application Credit

FAST technology modules

Technology module		Function	Points for use
Register control		Implementation of a clock-synchronised drive for generating a register control with print mark detection.	100
Winder Dancer		Implementation of a winding drive with dancer position control and/or a winding drive with tensile force/speed control	
Table Positioning		Positioning profiles for single axes with smoothing and touch probe positioning	50
Flying Saw		Cutting and processing of material while moving	100
Temperature Control		Control of the temperature of a system that is provided with a heating element and a thermal sensor.	50
Smart Track		Distribution of products via several conveying belts. An intelligent distribution results in optimum packaging of products.	
Magic Track		The preparation of single products to package them in groups. Is implemented comfortably with the two-pass conveyor.	

3.3

Controller 3200 C

Accessories



Application Credit

FAST technology modules



Coordinated multi-axes drives

3.3

Technology module		Function	Kinematics		Function	Points for use
Pick&Place		Implementation of complex three-dimensional movements by means of profiles for up to four drives with different kinematics.	Portal		Universal Cartesian portal kinematics with 2, 3 and 4 degrees of freedom for Pick&Place with high load capacities and big work-spaces	100
			Belt		Universally usable belt kinematics with 2 degrees of freedom *	
			Delta 2		Parallel kinematics with 2 degrees of freedom * for highly dynamic Pick&Place tasks	200
			Delta 3		Parallel kinematics with 3 degrees of freedom * for highly dynamic Pick&Place tasks	
			LinearDelta 3		Parallel kinematics with 3 degrees of freedom with linear axes for dynamic pick & place tasks.	
			Scara		Universal serial Scara kinematics with 2 and 3 degrees of freedom	
			Articulated P		Special form of an articulated arm kinematics with 4 degrees of freedom especially suitable for palletizing	
Track Pick & Place		Implementation of gripper movements which, for instance, pick up workpieces from a conveying belt and place or position them onto another conveying belt				300

FAST dimensioning

The FAST modules can be connected easily with the PLC Designer. Which module is to be selected, depends on the automation dimensioning of the machine. In order to define the correct Application Credit, the points of each module simply have to be added up. The required Application Credit is deducted each time a technology module is called.

Example 1:

- 1x Virtual Master (25 points)
- 1x Electrical Shaft (25 points)
- 2x Winder Dancer (200 points)
- 1x Cross Cutter (100 points)

Result: 350 points

Example 2:

- 1x Virtual Master (25 points)
- 1x Electrical Shaft (25 points)
- 2x Flex Cam (100 points)

Result: 150 points

Controller 3200 C

Accessories



Application Credit



FAST Motion

FAST Motion provides a scalable programming of function blocks based on "PLCopen Motion Control".

If you use the technology modules in the application, the basic functions of the FAST Motion are accessed both for single axes and for coordinated multi-axes systems.

If you do not want to use the technology modules for the motion control in your application, the application can, for instance, be implemented as well with your own program code on the basis of the FAST Motion.

3.3

Fast Motion		Function	Points for use
Motion Control		Positioning: FAST Motion basic functions for single-axis movements according to PLCopen Motion Control (formerly part 1) for positioning. This serves to freely program flexible positioning modes and further single-axis movements in IEC 61131.	150
		Camming: FAST Motion basic functions for synchronisation and cam movements according to PLCopen Motion Control (formerly part 2). This serves to freely program flexible axis synchronisations and cams for single axes in IEC 61131.	
Coordinated Motion		Robotics: FAST Motion basic functions for coordinated three-dimensional movements according to PLCopen Coordinated Motion Control (part 4). This serves to interpolate flexible axis groups as, for instance, robot kinematics in a multidimensional space. Programming is made in IEC 61131. Also contains "Positioning" and "Camming".	300

If you use FAST technology modules, the Application Credit already includes the required function of the FAST Motion. In this case, no additional points have to be considered for the use of the FAST Motion.

If you use the FAST Motion as a basic function for the motion control, the points according to the FAST Motion table apply.

Controller 3200 C

Accessories



SD card and USB flash drive

SD cards and USB flash drives are available for data storage and data backups.

- ▶ A SD card is part of the scope of supply of the controller.
- ▶ SD card without Application Credit.

Mode		Features	Product key
Application Credit 0		<ul style="list-style-type: none"> • 512 MB 	
USB flash drive		<ul style="list-style-type: none"> • 1 GB 	EPCZEMUS4
		<ul style="list-style-type: none"> • 4 GB 	EPCZEMUS6

3.3

24 V power supply unit

An external power supply unit is also available as an alternative for powering the controller's control electronics.



24 V power supply unit

Rated data

Product key				EZV2400-000
Rated voltage				
AC	$U_{N, AC}$	[V]		230
Rated mains current				
	$I_{N, AC}$	[A]		1.20
Output voltage				
	U_{out}	[V]		DC 22.5 ...28.5
Rated current				
	I_N	[A]		10.0
Dimensions				
	h x b x t	[mm]		130 x 85 x 125
Mass				
	m	[kg]		1.24





Controller 3200 C

Accessories



CAN bus connector

The connector is used to connect the CAN to inverters which are provided with a Sub-D connection for the CAN bus. An integrated CAN terminating resistor can be switched on/off. Internal spring terminals make the use of special mounting tools superfluous. The switch setting can be read from two sides.

Mode		Features	Product key
CAN bus connector: Node		<ul style="list-style-type: none"> • Sub-D, 90° • Screw terminals 	EPM-T950
CAN bus connector: Terminating		<ul style="list-style-type: none"> • Sub-D, 90° • Screw terminals • Integrated terminating resistor 	EPM-T951
CAN bus connector: Straight		<ul style="list-style-type: none"> • Sub-D, 180° • Screw terminals • Switchable terminating resistor 	EPM-T952
CAN bus connector: Switch		<ul style="list-style-type: none"> • Sub-D, 90° • Spring-loaded terminal • Switchable terminating resistor 	EWZ0046

MC cards

In addition to the available standard interfaces, the Controllers can be optionally extended with further fieldbuses. This enables a very universal implementation into the machine control. These fieldbuses can be ordered or retrofitted as MC cards.

Mode	Features	Product key
MC card	• 2 x CAN interface (MC-CAN2)	EPCZEBKM9
	• 1 x PROFIBUS master (MC-PBM)	EPCZEBKM5
	• 1 x PROFIBUS slave (MC-PBS)	EPCZEBKM6
	• 1 x PROFINET device (MC-PND)	EPCZEBKM8
	• 1 x RS232, RS422, RS485 (MC-ISI)	EPCZEBKMD
	• 1 x EtherNet (MC-ETH)	EPCZEBKM1

Controller c300



Controller c300

Contents



General information	Product key	3.4 - 4
	Equipment	3.4 - 5
	Product information	3.4 - 6
	Lenze FAST	3.4 - 8
Technical data	Standards and operating conditions	3.4 - 11
	Rated data	3.4 - 12
	Dimensions	3.4 - 13
Interfaces	Connection plan	3.4 - 14
	Mains connection	3.4 - 14
Accessories	Safety Controller	3.4 - 15
	Application Credit	3.4 - 16
	SD card and USB flash drive	3.4 - 19
	24 V power supply unit	3.4 - 19

Controller c300

General information



Product key

Product

c 3 0 0

Product key

C 3 0 G A C 0 0 0 0 0 F 3 G XXX - 0 2 S 3 0 0 0 0 0

Option interface MC 1

0 – No
8 – MC-PND (PROFINET Device)

Operating system

C – WEC7 Core

Runtime software control technology

3 – FAST Runtime

3.4



Controller c300

Controller c300

General information



Equipment

4 LEDs

Status display

CANopen Master and Slave

Status display

I/O System 1000

- up to 64 modules
- Analog and digital inputs and outputs
- additional modules

USB

USB flash drive connection for backup and maintenance

SD card

Data memory for project data

Option interface

Bus system extension

LAN 1

Ethernet 10/100 Mbps

Supply voltage

DC 24 V

EtherCAT Master



3.4

Safety topology extension

Safety-Controller c250-Sx

Safety-I/O-Modul

Safety-bus coupler

Unlocking mechanism

Status-LEDs

Network Out

Network In

24-V-connection

Additional shield connection

E-Bus

(covered)

Status-LEDs

Terminal strip

IO-LEDs



Controller c300

General information



Product information

Based on the 3200 C, the c300 fits seamlessly into our platform which is built on a consistently modern system architecture. The benefits: within the Controller-based Automation system, the precisely tailored Controller c300 takes responsibility for all of your control tasks. It focusses primarily on basic control (PLC) and motion tasks. Space-saving and intelligent at the same time.

Highlights

- Small control system with I/O modules which can be connected in series and integrated master interfaces for EtherCAT and CanOpen
- Easy standard set-up and data backup via USB flash drive
- Can be extended with communication interface PROFINET-Device)
- Future-proof due to compliance with industrial standards
- High system-availability
 - Integrated UPS solution
 - Easy device replacement thanks to replaceable memory card
- No maintenance required thanks to batteryless and fanless design



I/O system 1000 as local I/Os

At a speed of 48 Mbps, which is extremely fast, the c300 controller and the I/O modules communicate with each other via an extremely efficient backplane bus. Like this, it is possible to mount a great variety of configurations of the IO system directly on the controller in a flexible fashion. Precisely tailored to your application.

Safety topology with EtherCAT®

The Safety Controller c250-S clears the way for planning the complete drive and safety technology from one single source. The entire machine safety can be programmed with only one engineering tool, based on the PLCOpen standard - irrespective whether it is about "grey" or "yellow" control technology.

The deep integration of the functional safety into the automation system makes the engineering easier, improves the diagnostics options and reduces the number of interfaces and components.

This saves time and money and finally increases the availability and flexibility of the machine.

Controller c300

General information



Product information



Logic (PLC) and motion in a single device

- Optimised for machines/machine modules with central motion control
- Easy engineering thanks to central data storage



High-precision control for optimum manufacturing results

- Touch probe-compatible inputs
- High-precision output control
- Highly deterministic backplane bus with precise 1 μ s time stamp



Easy to use

- Automated standard set-up and data backup via USB stick
- Easy device replacement by the pluggable SD card Application Credit 0
- Diagnostics via implemented web server or EASY Starter

IEC 61131-3



Prepared for the future thanks to compliance with industrial standards

- Programming in IEC61131-3
- Motion Control as per PLCopen
- PLC Designer based on CODESYS3



Communicative

- EtherCAT® as a fast bus system directly on board (in preparation)
- CANopen on board
- Precisely tailored by modular extension option



I/O system 1000 as local I/Os

- Permanent wiring due to separation of electronics and base module
- Fast diagnostics achieved thanks to clear labelling of the LEDs assigned to each channel
- Easy connection thanks to inclusion of printed circuit diagram
- Fully integrated shield connection without special shield terminals

Controller c300

General information



Lenze FAST

Lenze FAST (Feasibly Applicable Software Toolbox) provides Lenze standard software modules for easily developing a modular machine control.

For this purpose, the »PLC Designer« engineering tool with the "FAST Application Template" provides for an easy programming and commissioning as standardised software structure and with predefined technology modules.

FAST Motion functions serve to implement individual extensions. The »EASY Starter« can be used to subsequently optimise and diagnose the system.

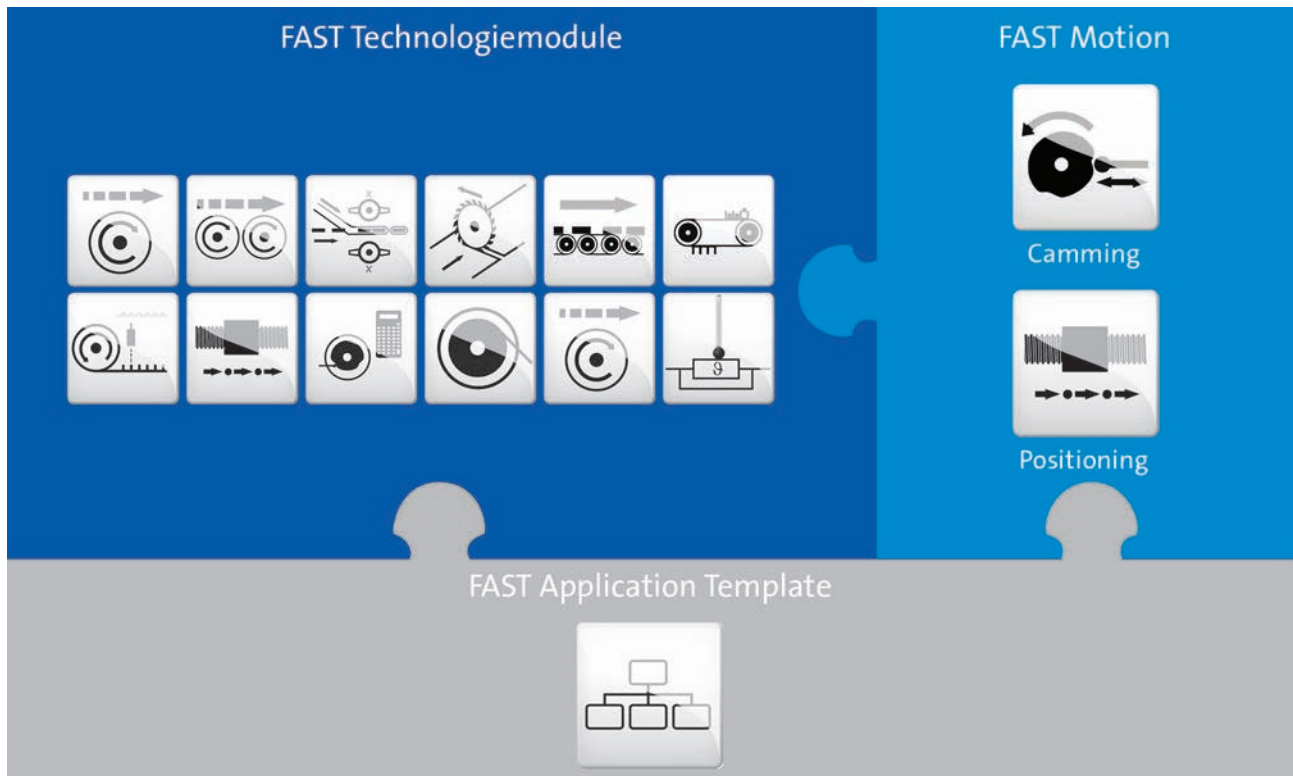

3.4

FAST Application Template

The FAST Application Template is standardised by Lenze for a modularised and clear programming in the »PLC Designer«.

The FAST Application Template can be used via a library in the »PLC Designer«. The library contains the structure and basic functionality of the FAST Application Template (as, for instance, state machine and error handling).

Controller c300

General information



Lenze FAST

FAST technology modules

The predefined FAST technology modules serve to easily implement the desired machine functions.

The FAST technology modules are standardised software modules for a modular programming of the machine control. A FAST technology module features a complete and pre-tested drive function. Integrated basic functions and an integrated visualisation provide for an easy commissioning and testing of the modules. The reusability of the modules increases the quality of the software and considerably reduces the time required for programming, commissioning and testing.

FAST Motion

FAST Motion provides full flexibility and scalability for programming and comprises optimised function blocks based on "PLCopen motion control":

- "Motion Control" modules (based on PLCopen Motion Control (formerly part 1+2) are optimised for the basic functions "positioning" and "cams" (synchronising).

The FAST technology modules are contained in the »PLC Designer« as independent function blocks in a library. They use the standardised interfaces and can thus be easily integrated into the machine program, combined in any way and extended individually with FAST Motion functions.

If the functionalities of the FAST technology modules are not sufficient, they can be adapted and extended individually using the FAST Motion modules. These modules are capable to program any number of functions.

The »PLC Designer« contains the "Motion Control" modules in two libraries.

Controller c300

General information



Controller c300

Technical data



Standards and operating conditions

Mode			
Controller			c300
Conformity			
CE			Low-Voltage Directive 2014/30/EU
EAC			TP TC 020/2011 (TR CU 020/2011)
Approval			
UL 508C			Process Control Equipment (File-No. E236341)
UL/CSA			CSA C22.2 No. 61010-2-201 UL 61010-2-201
Degree of protection			
EN 60529			IP20
NEMA 250			
Climatic conditions			
Storage (EN 60721-3-1)			1K3 (Temperature: -5 °C ... +45 °C)
Transport (EN 60721-3-2)			2K3 (temperature: -25 °C ... +70 °C)
Operation (EN 60721-3-3)			3K3 (temperature: 0 °C ... +55 °C)
Degree of pollution			
EN 61131-2			2
Site altitude			
Amsl	H _{max}	[m]	2000
Vibration resistance			
Vibration (EN 61131-2)			1 g
Mechanical shock (EN 61131-2)			15 g
Noise emission			
EN 61000-6-4			Industrial premises
Noise immunity			
EN 61000-4-2			ESD: Severity 3
EN 61000-4-6			150 kHz ... 80 MHz, 10 V/m 80 % AM (1 kHz)
EN 61000-4-3			80 kHz ... 1000 MHz, 10 V/m 80 % AM (1 kHz) 1.4 GHz ... 2.0 GHz, 3 V/m, 80 % AM (1kHz) 2.0 GHz ... 2.7 GHz, 1 V/m, 80 % AM (1kHz)
EN 61000-4-4			Burst: Severity 3

3.4

Controller c300

Technical data



Rated data

			
Mode			
Controller			c300
Processor type			
Fanless			ARM Cortex A8800
Storage medium			
SD card		[MB]	512
Interfaces			
Ethernet			1
EtherCAT Master			1
CANopen			1
USB			1
Rated voltage			
DC	$U_{N,DC}$	[V]	24
Max. current consumption			
With connected I/Os	I_{max}	[A]	0.70
Without connected I/Os	I_{max}	[A]	0.60
Operating system			
			Windows® Embedded Compact 7
Memory size			
Retain data		[kB]	128
Main memory (RAM)		[MB]	512
Min. internal flash memory		[GB]	2
Runtime			
FAST Runtime			●
Visualisation			●
Dimensions			
	h x b x t	[mm]	127 x 42 x 102
Mass			
	m	[kg]	0.33

3.4

Controller c300

Technical data



Dimensions

Without PROFINET



3.4

With PROFINET



Dimensions [mm]

Controller c300

Interfaces



Connection plan

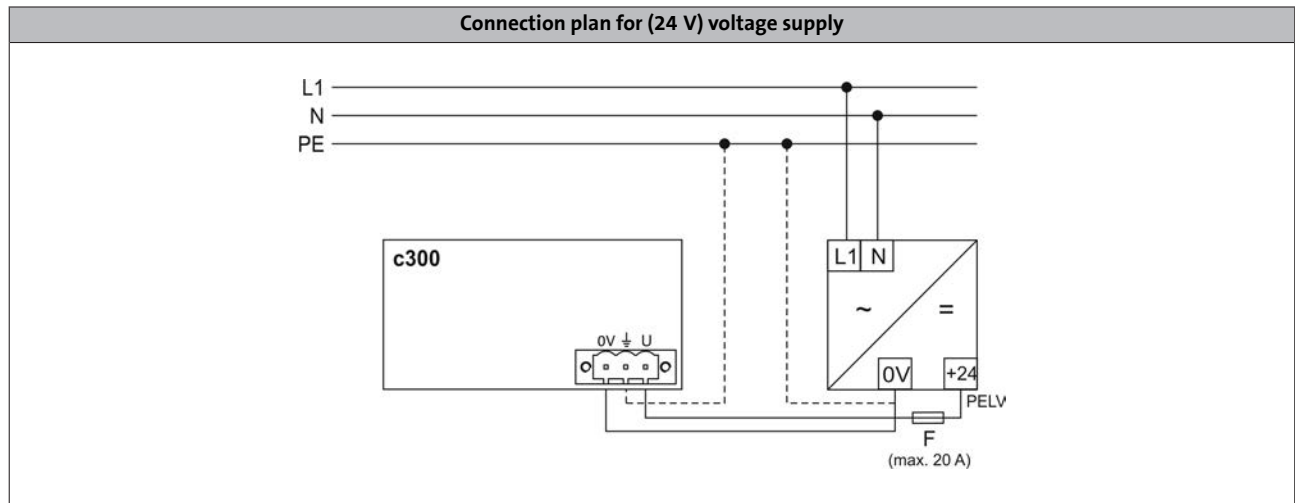

3.4

Mains connection

	Connection	Connection type	Cable type
	DC supply (24 V)	3-pole Combicon socket	Cable with Combicon-plug (cable cross-section max. 2.5 mm ²)

Controller c300

Accessories



Safety Controller

Safety in the system does not begin with the drives first, but at the control level.

With the expansion of the controller software to include the Safety Controller c250-S a complete automation solution is provided for safety engineering and control and drive tasks. Topped with the safety I/O module, all the safety aspects in the machine module can be evaluated. EtherCAT is used for data transfer.



3.4

Mode		Features	Product key
Safety Controller c250-S	-	<ul style="list-style-type: none"> Compact Controller c250-S for easy mounting using the DIN rail High-quality safety solution thanks to PL e/SIL 3 	C25BAYSQ
Safety bus coupler	-	<ul style="list-style-type: none"> Supported network: EtherCAT with safety-over EtherCAT (FSoE = Fail Safe over EtherCAT) 	C25BAYCB
Safety I/O module	-	<ul style="list-style-type: none"> Expansion of the Safety Controller with 4 safe inputs and 2 safe outputs 	C25BAYA42

Safety Controller	
Functions	Implementation according to PLCopen, TC 5
Equivalence / antivalence test	SF_Equivalent SF_Antivalent
Operation mode selector	SF_ModeSelector
Emergency stop, emergency off	SF_EmergencyStop
Monitoring of electro-sensitive protective equipment (ESPE)	SF_ESPE (electro-sensitive protective equipment)
Guard monitoring	SF_GuardMonitoring
Guard monitoring with locking	SF_GuardLocking
Two-hand control	SF_TwoHandControlTypeII SF_TwoHandControlTypeIII
Muting	SF_MutingSeq SF_MutingPar SF_MutingPar_2Sensors
Cyclic test of ESPE	SF_TestableSafetySensor
Enable switch	SF_EnableSwitch
Controlling safety output with standard controller and safety controller	SF_OutControl
Monitoring of feedback loop	SF_EDM (external device monitoring)

Technical data	
Rated current	240 mA via E-bus connection
DC supply voltage	5 V via E-bus connection 24 V via safety bus coupler
Dimensions h x w x d	120 mm x 25 mm x 90 mm
Degree of protection	IP20

Controller c300

Accessories



Application Credit

With Lenze FAST, technology modules for motion control are provided. In order that these modules are used, the following Application Credit is required. If different technology modules are used, the demand for Application Credit must be added for all modules used.





3.4

Mode		Features	Product key
Application Credit		• Licence for use of FAST Application Software, 100 points	EPCZEMSD0L1010
		• Licence for use of FAST Application Software, 150 points	EPCZEMSD0L1015
		• Licence for use of FAST Application Software, 200 points	EPCZEMSD0L1020
		• Licence for use of FAST Application Software, 300 points	EPCZEMSD0L1030
		• Licence for use of FAST Application Software, 400 points	EPCZEMSD0L1040
		• Licence for use of FAST Application Software, 500 points	EPCZEMSD0L1050
		• Licence for use of FAST Application Software, 600 points	EPCZEMSD0L1060
		• Licence for use of FAST Application Software, 700 points	EPCZEMSD0L1070
		• Licence for use of FAST Application Software, 1000 points	EPCZEMSD0L1100
		• Licence for use of FAST Application Software, 1200 points	EPCZEMSD0L1120
		• Licence for use of FAST Application Software, 1500 points	EPCZEMSD0L1150
		• Licence for use of FAST Application Software, 2000 points	EPCZEMSD0L1200
		• Licence for use of FAST Application Software, 2500 points	EPCZEMSD0L1250
		• Licence for use of FAST Application Software, 3000 points	EPCZEMSD0L1300
• Licence for use of FAST Application Software, 4000 points	EPCZEMSD0L1400		

FAST technology modules



Single drives

Technology module		Function	Points for use
Virtual Master		Implementation of a virtual master axis in the machine	25
Basic Motion		Provides easy basic motion functions: Manual jog, homing, absolute and relative positioning, continuous travel	
Electrical Shaft		Synchronisation and coupling of drives with precise speed and positioning.	
Flex Cam		Implementation of one or several electric cams. Flexible management of curves created online and offline.	50
Cross Cutter		Synchronised movements of drives for cross-sealing and/or cross-cutting of products.	100



Application Credit

FAST technology modules

Technology module		Function	Points for use
Register control		Implementation of a clock-synchronised drive for generating a register control with print mark detection.	100
Winder Dancer		Implementation of a winding drive with dancer position control and/or a winding drive with tensile force/speed control	
Table Positioning		Positioning profiles for single axes with smoothing and touch probe positioning	50
Flying Saw		Cutting and processing of material while moving	100
Temperature Control		Control of the temperature of a system that is provided with a heating element and a thermal sensor.	50
Track Pick & Place		Implementation of gripper movements which, for instance, pick up workpieces from a conveying belt and place or position them onto another conveying belt	300
Smart Track		Distribution of products via several conveying belts. An intelligent distribution results in optimum packaging of products.	50
Magic Track		The preparation of single products to package them in groups. Is implemented comfortably with the two-pass conveyor.	

3.4

FAST dimensioning

The FAST modules can be connected easily with the PLC Designer. Which module is to be selected, depends on the automation dimensioning of the machine. In order to define the correct Application Credit, the points of each module simply have to be added up. The required Application Credit is deducted each time a technology module is called.

Example 1:

- 1x Virtual Master (25 points)
- 1x Electrical Shaft (25 points)
- 2x Winder Dancer (200 points)
- 1x Cross Cutter (100 points)

Result: 350 points

Example 2:

- 1x Virtual Master (25 points)
- 1x Electrical Shaft (25 points)
- 2x Flex Cam (100 points)

Result: 150 points

Controller c300

Accessories





Application Credit

FAST Motion

FAST Motion provides a scalable programming of function blocks based on "PLCopen Motion Control".
If you use the technology modules in the application, the basic functions of the FAST Motion are accessed both for single axes and for coordinated multi-axes systems.
If you do not want to use the technology modules for the motion control in your application, the application can, for instance, be implemented as well with your own program code on the basis of the FAST Motion.

3.4

Fast Motion		Function	Points for use
Motion Control		Positioning: FAST Motion basic functions for single-axis movements according to PLCopen Motion Control (formerly part 1) for positioning. This serves to freely program flexible positioning modes and further single-axis movements in IEC 61131.	150
		Camming: FAST Motion basic functions for synchronisation and cam movements according to PLCopen Motion Control (formerly part 2). This serves to freely program flexible axis synchronisations and cams for single axes in IEC 61131.	

If you use FAST technology modules, the Application Credit already includes the required function of the FAST Motion. In this case, no additional points have to be considered for the use of the FAST Motion.

If you use the FAST Motion as a basic function for the motion control, the points according to the FAST Motion table apply.

Controller c300

Accessories



SD card and USB flash drive

SD cards and USB flash drives are available for data storage and data backups.

- ▶ A SD card is part of the scope of supply of the controller.
- ▶ SD card without Application Credit.

Mode		Features	Product key
Application Credit 0		<ul style="list-style-type: none"> • 512 MB 	
USB flash drive		<ul style="list-style-type: none"> • 1 GB 	EPCZEMUS4
		<ul style="list-style-type: none"> • 4 GB 	EPCZEMUS6

3.4

24 V power supply unit

An external power supply unit is also available as an alternative for powering the controller's control electronics.



24 V power supply unit

Rated data

Product key				EZV2400-000
Rated voltage				
AC	$U_{N, AC}$	[V]		230
Rated mains current				
	$I_{N, AC}$	[A]		1.20
Output voltage				
	U_{out}	[V]		DC 22.5 ...28.5
Rated current				
	I_N	[A]		10.0
Dimensions				
	h x b x t	[mm]		130 x 85 x 125
Mass				
	m	[kg]		1.24

Controller c300

Accessories



Controller p500



Controller p500

Contents



General information	Product key	3.5 - 4
	Equipment	3.5 - 5
	Product information	3.5 - 6
	Lenze FAST	3.5 - 8
Technical data	Standards and operating conditions	3.5 - 11
	Rated data	3.5 - 13
	Dimensions	3.5 - 15
Interfaces	Connection plan	3.5 - 16
	Mains connection	3.5 - 16
Accessories	Safety Controller	3.5 - 17
	Application Credit	3.5 - 18
	SD card and USB flash drive	3.5 - 22
	24 V power supply unit	3.5 - 22
	CAN bus connector	3.5 - 23
	Protection films	3.5 - 23
MC cards	3.5 - 23	

Controller p500

General information



Product key

Product

p 5 0 0

Product key

P 5 0 G A P 0 3 0 0 M 5 H X X X - 0 2 4 1 5 0 0 0

Display diagonal

9 – 17.8 cm (7 “)
4 – 26.4 cm (10.4 “)
6 – 38.1 cm (15 “)

Option interface MC 1

0 – No
6 – MC-PBS (PROFIBUS Slave)
8 – MC-PND (PROFINET Device)
9 – MC-CAN2 (CANopen)

Application Credit

S1 - Application Credit 0	AA - Application Credit 1200
A1 - Application Credit 100	AB - Application Credit 1500
A2 - Application Credit 150	AC - Application Credit 2000
A3 - Application Credit 200	AD - Application Credit 2500
A4 - Application Credit 300	AE - Application Credit 3000
A5 - Application Credit 400	AF - Application Credit 4000
A6 - Application Credit 500	
A7 - Application Credit 600	
A8 - Application Credit 700	
A9 - Application Credit 1000	

Runtime software control technology

0 – No
3 – FAST Runtime

3.5



Controller p500 - 17.8 cm (7")



Controller p500 - 26.4 cm (10.4")



Controller p500 - 38.1 cm (15")

Controller p500

General information



Equipment

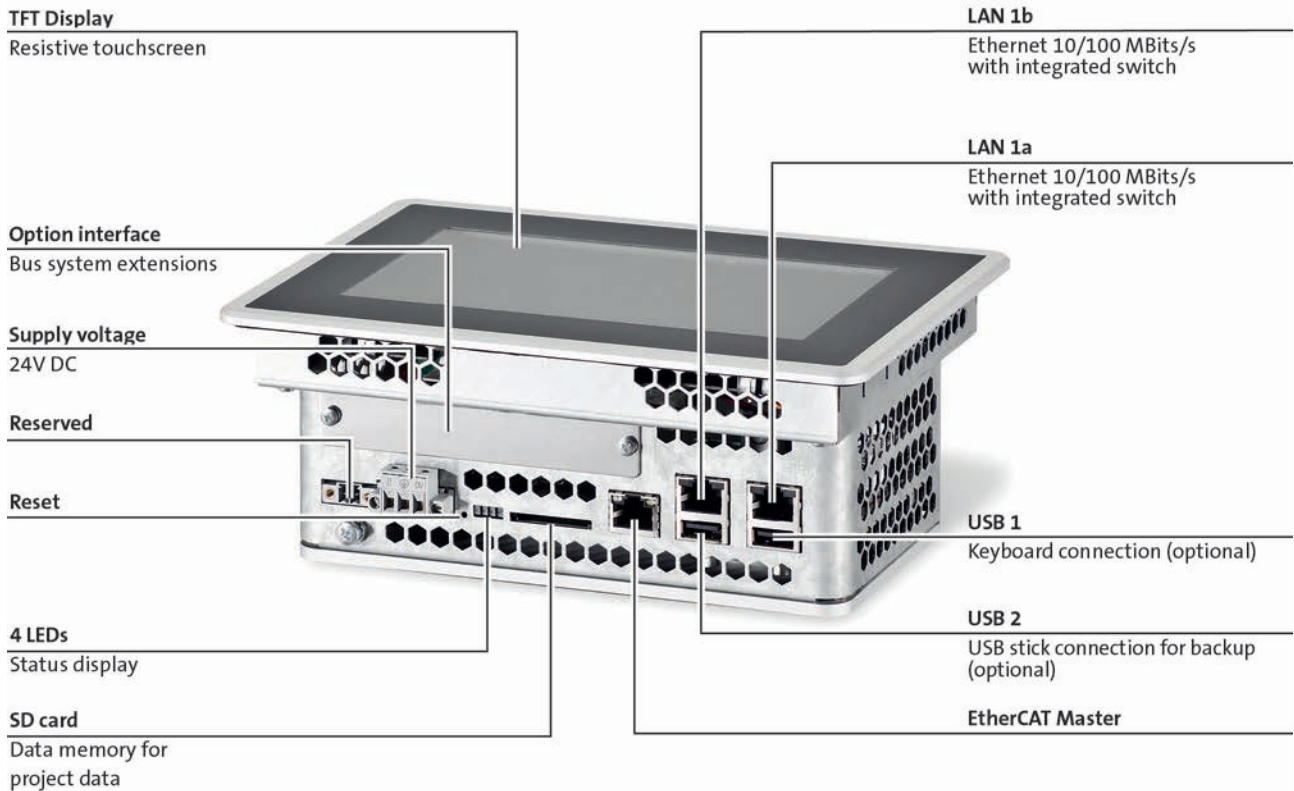

3.5

Safety topology extension

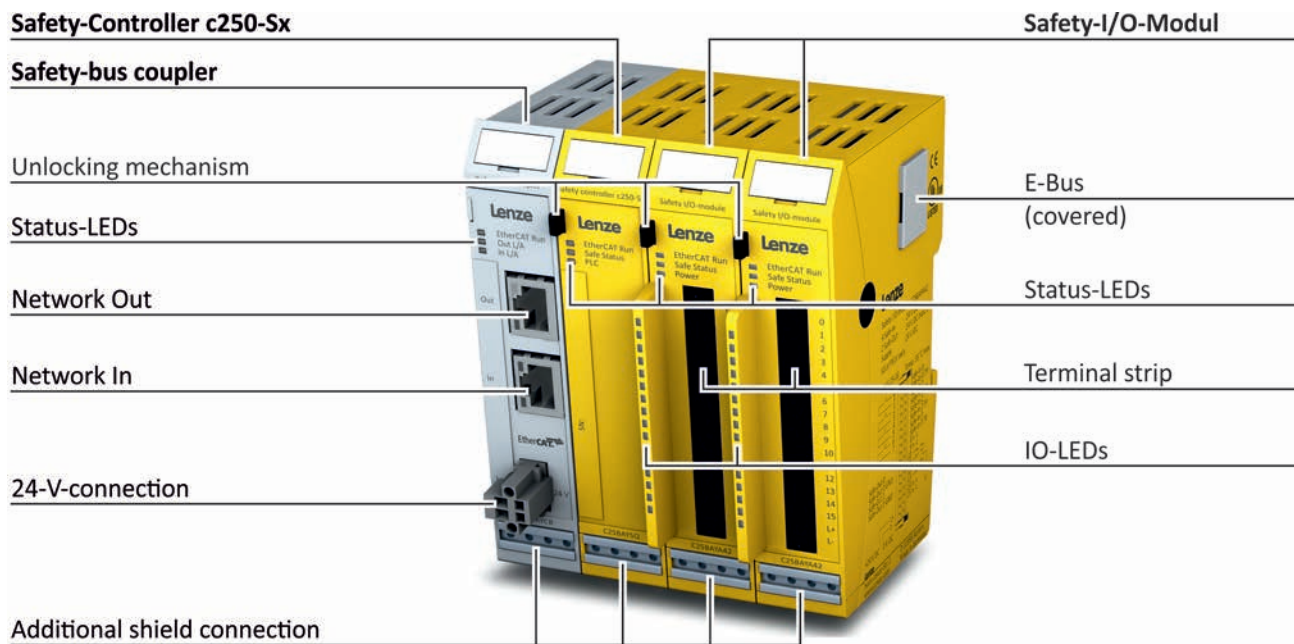

Controller p500

General information



Product information

Control and visualisation combined in a compact unit. We have taken yet another step towards creating an easier future with the p500 – a perfect combination of maintenance-free panel-mounted controller, logic (PLC), motion and visualisation in a single device. It is ideally suited for use as a control and visualisation system within Controller-based Automation systems, suiting applications with central motion control or as a visualisation device within a drive-based automation system.

Highlights

- Logic (PLC), motion and visualisation in a single device
- Machine-oriented and high-precision control for optimum manufacturing results
- Easy to use
- Prepared for the future thanks to compliance with industrial standards



Controller p500 - 38.1 cm (15")

Versions

The p500 device series encompasses 3 versions, which only differ in terms of their screen size. All other technical properties are absolutely identical.

Integrated Ethernet switch

The integrated switch allows line topologies to be established using Ethernet without the need for a separate switch as an infrastructure component. In addition to this, a free interface provides allows a diagnostics device such as a service technician's laptop to be connected without having to access the bus physics.

Safety topology with EtherCAT®

The Safety Controller c250-S clears the way for planning the complete drive and safety technology from one single source. The entire machine safety can be programmed with only one engineering tool, based on the PLCOpen standard - irrespective whether it is about "grey" or "yellow" control technology. The deep integration of the functional safety into the automation system makes the engineering easier, improves the diagnostics options and reduces the number of interfaces and components. This saves time and money and finally increases the availability and flexibility of the machine.

Controller p500

General information



Product information



Logic (PLC), motion and visualisation in a single device

- Optimised for machine(modules) with central motion control
- Easy engineering thanks to central data storage



Easy to use

- Easy use of FAST via pluggable SD card with Application Credit for Motion Control or Coordinated Motion
- Automated standard set-up and data backup via USB stick
- Easy device replacement by means of the pluggable SD card with the corresponding Application Credit
- Diagnostics by implemented web server or EASY Starter



High degree of system availability

- Maintenance-free
- Fanless
- No battery

IEC 61131-3



CODESYS

Prepared for the future thanks to compliance with industrial standards

- Programming in IEC61131-3
- Motion Control as per PLCopen
- PLC Designer based on CODESYS3



EtherCAT

Communicative

- EtherCAT® as a fast bus system directly on board (in preparation)
- CANopen on board
- Precisely tailored by modular extension option



Variable front panel concept

- Easy customizing of the front panels (foils, smart customising)

Controller p500

General information



Lenze FAST

Lenze FAST (Feasibly Applicable Software Toolbox) provides Lenze standard software modules for easily developing a modular machine control.

FAST Motion functions serve to implement individual extensions. The »EASY Starter« can be used to subsequently optimise and diagnose the system.

For this purpose, the »PLC Designer« engineering tool with the "FAST Application Template" provides for an easy programming and commissioning as standardised software structure and with predefined technology modules.

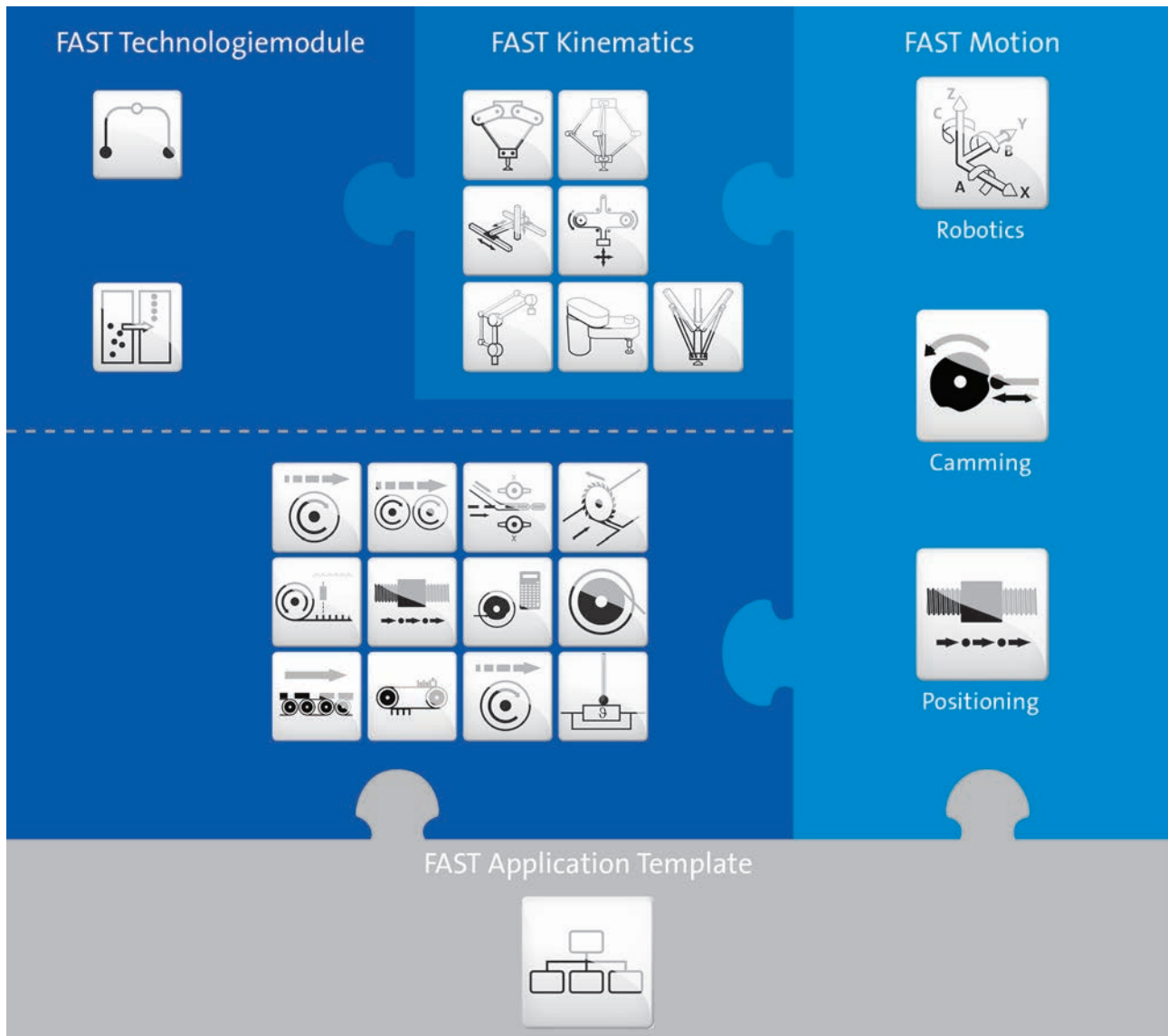

FAST Application Template

The FAST Application Template is standardised by Lenze for a modularised and clear programming in the »PLC Designer«.

The FAST Application Template can be used via a library in the »PLC Designer«. The library contains the structure and basic functionality of the FAST Application Template (as, for instance, state machine and error handling).

Controller p500

General information



Lenze FAST

FAST technology modules

The predefined FAST technology modules serve to easily implement the desired machine functions.

The FAST technology modules are standardised software modules for a modular programming of the machine control. A FAST technology module features a complete and pre-tested drive function. Integrated basic functions and an integrated visualisation provide for an easy commissioning and testing of the modules. The reusability of the modules increases the quality of the software and considerably reduces the time required for programming, commissioning and testing.

FAST Motion

FAST Motion provides full flexibility and scalability for machine programming and comprises optimised function blocks based on "PLCopen motion control":

- "Motion Control" modules (based on PLCopen Motion Control (formerly part 1+2) are optimised for the basic functions "positioning" and "cams" (synchronising).
- "Coordinated Motion" modules (based on PLCopen Coordinated Motion (part 4) are optimised for multi-axis coordinated three-dimensional movements – which can also be controlled via the FAST technology modules "Pick & Place".

The FAST technology modules are contained in the »PLC Designer« as independent function blocks in a library. They use the standardised interfaces and can thus be easily integrated into the machine program, combined in any way and extended individually with FAST Motion functions.

If the functionalities of the FAST technology modules are not sufficient, they can be adapted and extended individually using the FAST Motion modules. These modules are capable to program any number of functions.

The »PLC Designer« contains the "Motion Control" modules in two libraries and the "Coordinated Motion" modules in one library.

Controller p500

General information





Standards and operating conditions

Relative humidity

3.5

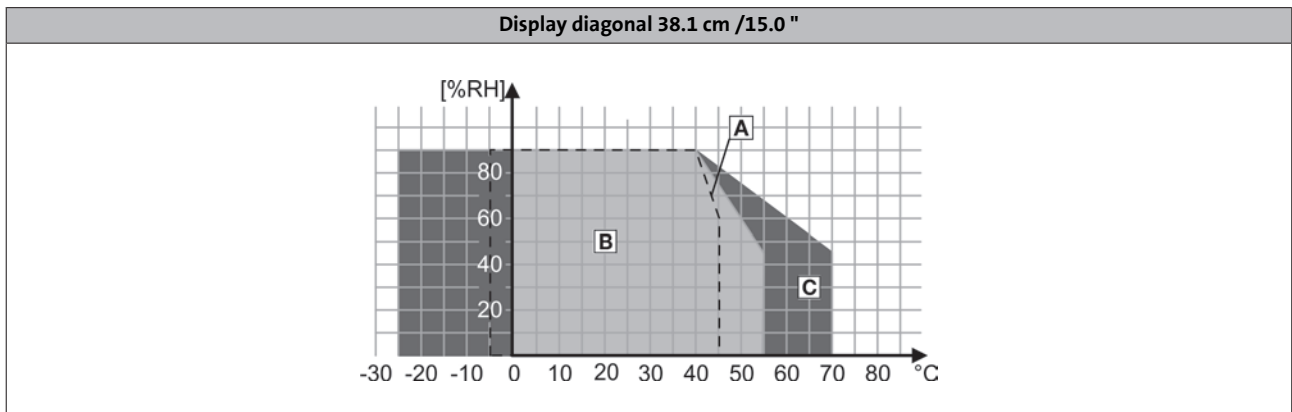
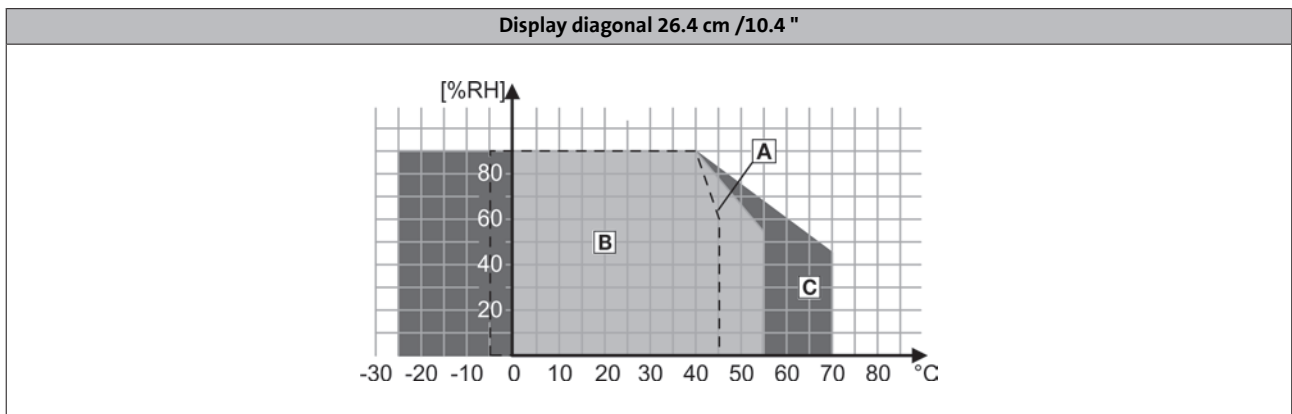
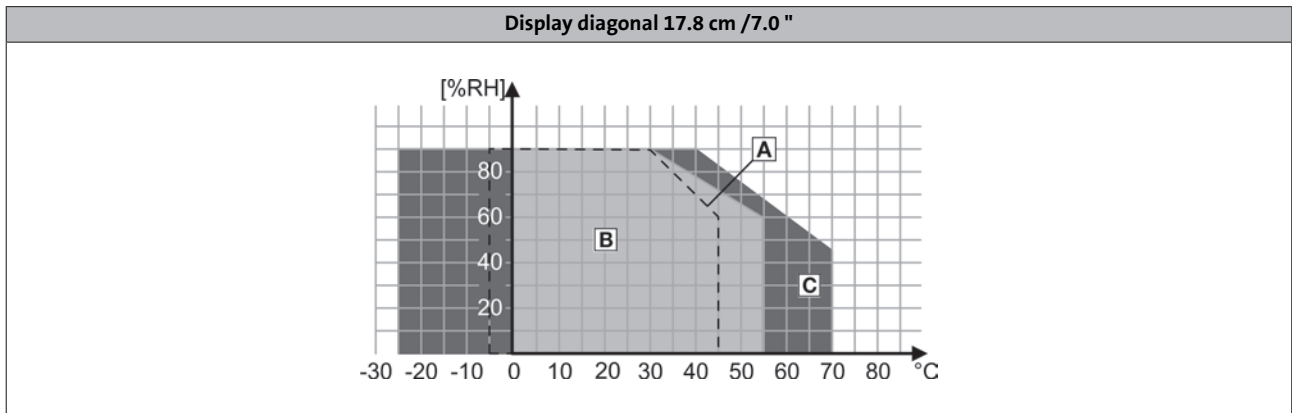



- [A] Storage
- [B] Operation
- [C] Transport

Controller p500

Technical data



Rated data

							
Mode							
Controller				p500			
Display							
Screen diagonal		[cm]	17.8	26.4	38.1		
		["]	7.0	10.4	15.0		
Display				TFT			
Design				color			
Type				Graphics			
Number of colours				262144			
Resolution				[Pixel]	800 x 480	800 x 600	1024 x 768
Brightness				[cd/m ²]	320	400	
Contrast					1 : 400	1 : 700	
Operator control							
Screen				Resistive touchscreen			
Processor type							
Fanless				Intel® Atom™ 1.75 GHz			
Storage medium							
SD card ¹⁾				[MB]	512		
Interfaces							
Ethernet (integrated switch)				2			
EtherCAT				1			
USB				2			
Option				Interface connection for CANopen (MC-CAN2) Interface connection for PROFIBUS Slave (MC-PBS) Interface connection for PROFINET-Device (MC-PND) Interface connection for EtherNet (MC-ETH) Interface connection for RS232, 422, 485 (MC-ISI)			
Supply voltage							
DC	U _{in}	± 25 %	[V]	24			
Max. current consumption							
	I _{max}		[A]	0.50 ²⁾ 1.20 ³⁾	0.60 ²⁾ 1.30 ³⁾	0.70 ²⁾ 1.50 ³⁾	
Operating system				Windows® CE 6.0			

3.5

¹⁾ 1 x SD card included in the scope of supply.

²⁾ Without optional cards and USB load.



³⁾ 2x 500 mA USB 1+2, with MC-CAN2 module, 30 s max. after switching-on.

Controller p500

Technical data



Rated data

					
Mode					
Controller			p500		
Display					
Screen diagonal		[cm]	17.8	26.4	38.1
		["]	7.0	10.4	15.0
Memory size					
Program memory			512		
Data memory			4000		
Flags			4		
Retain data			1024		
Max. number of persistently saved visualisation alarms			10000		
Main memory (RAM)			2		
Min. internal flash memory			4		
Runtime					
FAST Runtime ¹⁾			●		
Visualisation			●		
Dimensions					
	h x b x t	[mm]	155 x 210 x 86	240 x 282 x 86	310 x 390 x 93
Mass					
	m	[kg]	1.40	2.50	4.50

¹⁾ Optional

3.5

Controller p500

Technical data



Dimensions

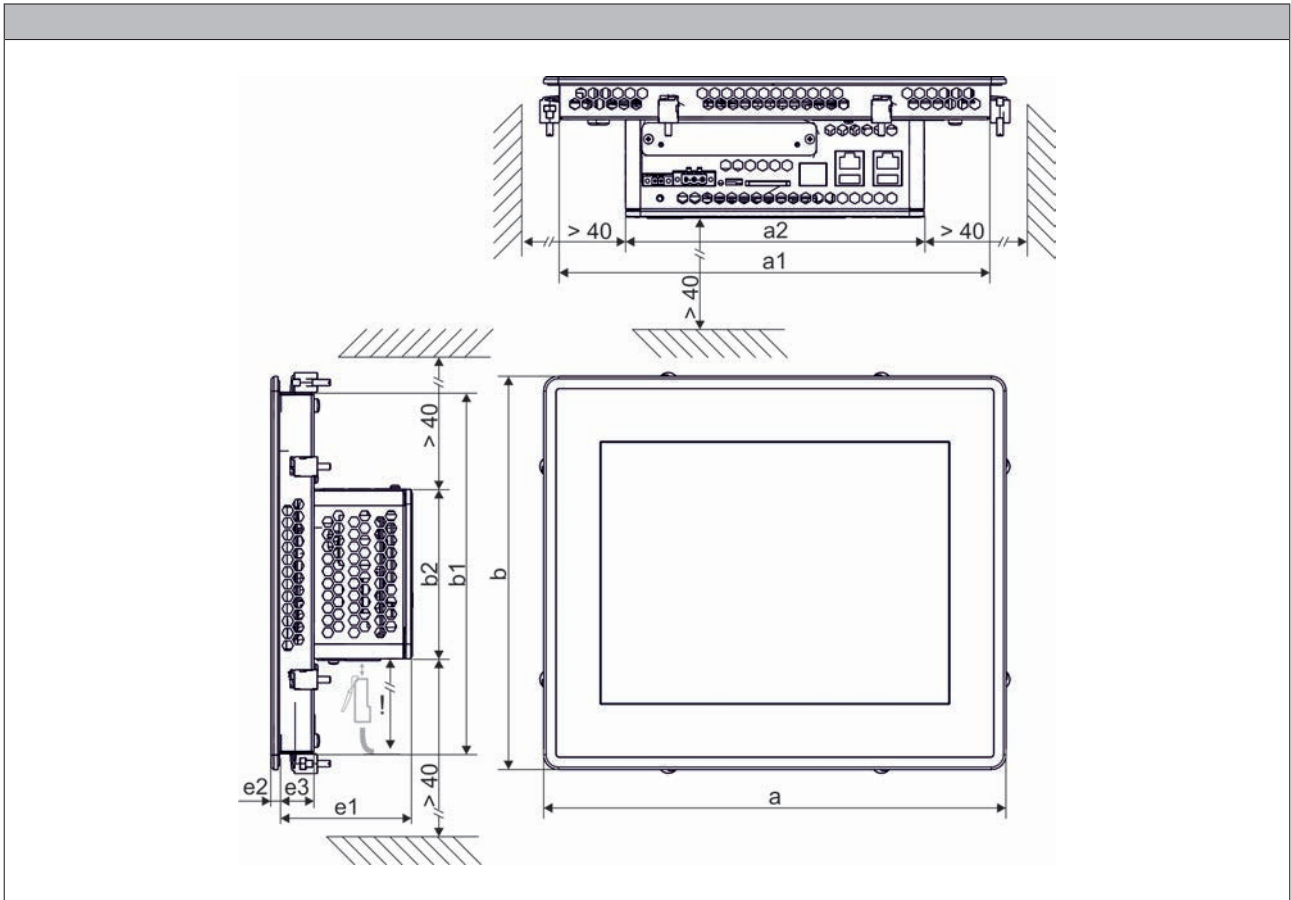

3.5

Display		Dimensions								
Screen diagonal		a	a ₁	a ₂	b	b ₁	b ₂	e ₁	e ₂	e ₃
[cm]	["]	[mm]	[mm]	[mm]	[mm]	[mm]	[mm]	[mm]	[mm]	[mm]
17.8	7.0	210	191	182	155	136	104	82.0	4.00	22.0
26.4	10.4	282	263	182	240	221	104	82.0	4.00	22.0
38.1	15.0	390	371	182	310	291	104	87.0	6.00	27.0



Connection plan

Connection plan for (24 V) voltage supply

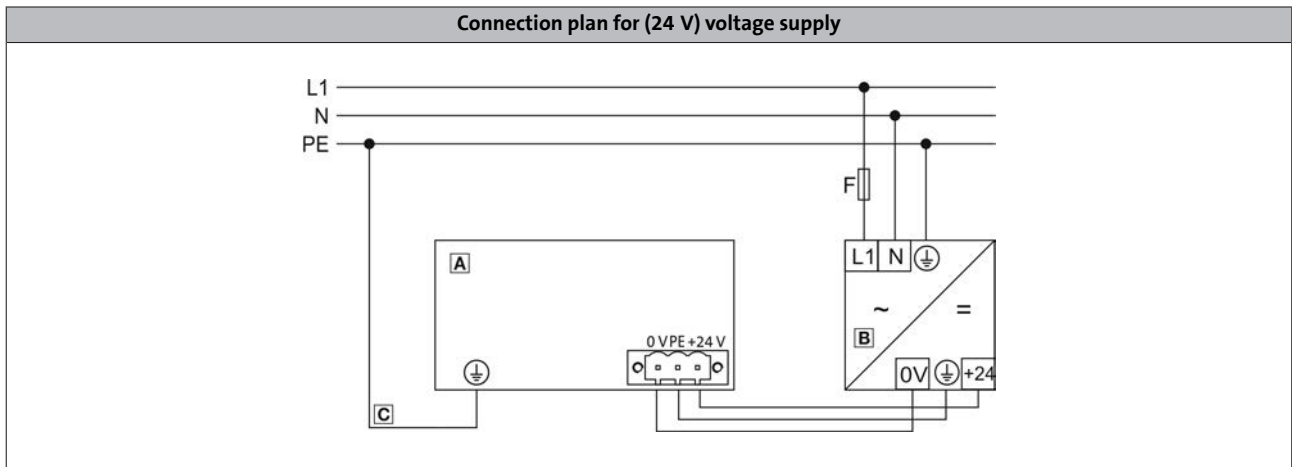

3.5

Position	Meaning
A	Controller
B	Power supply unit
C	Protective earth connection on the supply side (PE, internally bridged with GND)

Mains connection

	Connection	Connection type	Cable type
	DC supply (24 V)	3-pole Combicon socket	Cable with Combicon-plug (cable cross-section max. 2.5 mm ²)
	PE connection	M4 (PH 2)	Separate earth conductor (1.2 ... 2.5 mm ² with ring cable lug)

Controller p500

Accessories



Safety Controller

Safety in the system does not begin with the drives first, but at the control level.

With the expansion of the controller software to include the Safety Controller c250-S a complete automation solution is provided for safety engineering and control and drive tasks. Topped with the safety I/O module, all the safety aspects in the machine module can be evaluated. EtherCAT is used for data transfer.



3.5

Mode		Features	Product key
Safety Controller c250-S	-	<ul style="list-style-type: none"> Compact Controller c250-S for easy mounting using the DIN rail High-quality safety solution thanks to PL e/SIL 3 	C25BAYSQ
Safety bus coupler	-	<ul style="list-style-type: none"> Supported network: EtherCAT with safety-over EtherCAT (FSoE = Fail Safe over EtherCAT) 	C25BAYCB
Safety I/O module	-	<ul style="list-style-type: none"> Expansion of the Safety Controller with 4 safe inputs and 2 safe outputs 	C25BAYA42

Safety Controller	
Functions	Implementation according to PLCopen, TC 5
Equivalence / antivalence test	SF_Equivalent SF_Antivalent
Operation mode selector	SF_ModeSelector
Emergency stop, emergency off	SF_EmergencyStop
Monitoring of electro-sensitive protective equipment (ESPE)	SF_ESPE (electro-sensitive protective equipment)
Guard monitoring	SF_GuardMonitoring
Guard monitoring with locking	SF_GuardLocking
Two-hand control	SF_TwoHandControlTypeII SF_TwoHandControlTypeIII
Muting	SF_MutingSeq SF_MutingPar SF_MutingPar_2Sensors
Cyclic test of ESPE	SF_TestableSafetySensor
Enable switch	SF_EnableSwitch
Controlling safety output with standard controller and safety controller	SF_OutControl
Monitoring of feedback loop	SF_EDM (external device monitoring)

Technical data	
Rated current	240 mA via E-bus connection
DC supply voltage	5 V via E-bus connection 24 V via safety bus coupler
Dimensions h x w x d	120 mm x 25 mm x 90 mm
Degree of protection	IP20

Controller p500

Accessories



Application Credit

With Lenze FAST, technology modules are provided for Motion Control and Coordinated Motion. In order that these modules are used, the following Application Credit is required. If different technology modules are used, the demand for Application Credit must be added for all modules used.





3.5

Mode		Features	Product key
Application Credit		• Licence for use of FAST Application Software, 100 points	EPCZEMSD0L1010
		• Licence for use of FAST Application Software, 150 points	EPCZEMSD0L1015
		• Licence for use of FAST Application Software, 200 points	EPCZEMSD0L1020
		• Licence for use of FAST Application Software, 300 points	EPCZEMSD0L1030
		• Licence for use of FAST Application Software, 400 points	EPCZEMSD0L1040
		• Licence for use of FAST Application Software, 500 points	EPCZEMSD0L1050
		• Licence for use of FAST Application Software, 600 points	EPCZEMSD0L1060
		• Licence for use of FAST Application Software, 700 points	EPCZEMSD0L1070
		• Licence for use of FAST Application Software, 1000 points	EPCZEMSD0L1100
		• Licence for use of FAST Application Software, 1200 points	EPCZEMSD0L1120
		• Licence for use of FAST Application Software, 1500 points	EPCZEMSD0L1150
		• Licence for use of FAST Application Software, 2000 points	EPCZEMSD0L1200
		• Licence for use of FAST Application Software, 2500 points	EPCZEMSD0L1250
		• Licence for use of FAST Application Software, 3000 points	EPCZEMSD0L1300
• Licence for use of FAST Application Software, 4000 points	EPCZEMSD0L1400		

FAST technology modules









Single drives

Technology module		Function	Points for use
Virtual Master		Implementation of a virtual master axis in the machine	25
Basic Motion		Provides easy basic motion functions: Manual jog, homing, absolute and relative positioning, continuous travel	
Electrical Shaft		Synchronisation and coupling of drives with precise speed and positioning.	
Flex Cam		Implementation of one or several electric cams. Flexible management of curves created online and offline.	50
Cross Cutter		Synchronised movements of drives for cross-sealing and/or cross-cutting of products.	100



Application Credit

FAST technology modules

Technology module		Function	Points for use
Register control		Implementation of a clock-synchronised drive for generating a register control with print mark detection.	100
Winder Dancer		Implementation of a winding drive with dancer position control and/or a winding drive with tensile force/speed control	
Table Positioning		Positioning profiles for single axes with smoothing and touch probe positioning	50
Flying Saw		Cutting and processing of material while moving	100
Temperature Control		Control of the temperature of a system that is provided with a heating element and a thermal sensor.	50
Smart Track		Distribution of products via several conveying belts. An intelligent distribution results in optimum packaging of products.	
Magic Track		The preparation of single products to package them in groups. Is implemented comfortably with the two-pass conveyor.	

3.5



Application Credit

FAST technology modules



Coordinated multi-axes drives

3.5

Technology module		Function	Kinematics		Function	Points for use
Pick&Place		Implementation of complex three-dimensional movements by means of profiles for up to four drives with different kinematics.	Portal		Universal Cartesian portal kinematics with 2, 3 and 4 degrees of freedom for Pick&Place with high load capacities and big work-spaces	100
			Belt		Universally usable belt kinematics with 2 degrees of freedom *	
			Delta 2		Parallel kinematics with 2 degrees of freedom * for highly dynamic Pick&Place tasks	200
			Delta 3		Parallel kinematics with 3 degrees of freedom * for highly dynamic Pick&Place tasks	
			LinearDelta 3		Parallel kinematics with 3 degrees of freedom with linear axes for dynamic pick & place tasks.	
			Scara		Universal serial Scara kinematics with 2 and 3 degrees of freedom	
			Articulated P		Special form of an articulated arm kinematics with 4 degrees of freedom especially suitable for palletizing	
Track Pick & Place		Implementation of gripper movements which, for instance, pick up workpieces from a conveying belt and place or position them onto another conveying belt				300

FAST dimensioning

The FAST modules can be connected easily with the PLC Designer. Which module is to be selected, depends on the automation dimensioning of the machine. In order to define the correct Application Credit, the points of each module simply have to be added up. The required Application Credit is deducted each time a technology module is called.

Example 1:

- 1x Virtual Master (25 points)
- 1x Electrical Shaft (25 points)
- 2x Winder Dancer (200 points)
- 1x Cross Cutter (100 points)

Result: 350 points

Example 2:

- 1x Virtual Master (25 points)
- 1x Electrical Shaft (25 points)
- 2x Flex Cam (100 points)

Result: 150 points





Application Credit

FAST Motion

FAST Motion provides a scalable programming of function blocks based on "PLCopen Motion Control".

If you use the technology modules in the application, the basic functions of the FAST Motion are accessed both for single axes and for coordinated multi-axes systems.

If you do not want to use the technology modules for the motion control in your application, the application can, for instance, be implemented as well with your own program code on the basis of the FAST Motion.

Fast Motion		Function	Points for use
Motion Control		Positioning: FAST Motion basic functions for single-axis movements according to PLCopen Motion Control (formerly part 1) for positioning. This serves to freely program flexible positioning modes and further single-axis movements in IEC 61131.	150
		Camming: FAST Motion basic functions for synchronisation and cam movements according to PLCopen Motion Control (formerly part 2). This serves to freely program flexible axis synchronisations and cams for single axes in IEC 61131.	
Coordinated Motion		Robotics: FAST Motion basic functions for coordinated three-dimensional movements according to PLCopen Coordinated Motion Control (part 4). This serves to interpolate flexible axis groups as, for instance, robot kinematics in a multidimensional space. Programming is made in IEC 61131. Also contains "Positioning" and "Camming".	300

3.5

If you use FAST technology modules, the Application Credit already includes the required function of the FAST Motion. In this case, no additional points have to be considered for the use of the FAST Motion.

If you use the FAST Motion as a basic function for the motion control, the points according to the FAST Motion table apply.

Controller p500

Accessories



SD card and USB flash drive

SD cards and USB flash drives are available for data storage and data backups.

- ▶ A SD card is part of the scope of supply of the controller.
- ▶ SD card without Application Credit.

Mode		Features	Product key
Application Credit 0		<ul style="list-style-type: none"> • 512 MB 	
USB flash drive		<ul style="list-style-type: none"> • 1 GB 	EPCZEMUS4
		<ul style="list-style-type: none"> • 4 GB 	EPCZEMUS6

3.5

24 V power supply unit

An external power supply unit is also available as an alternative for powering the controller's control electronics.



24 V power supply unit

Rated data

Product key				EZV2400-000
Rated voltage				
AC	$U_{N, AC}$	[V]		230
Rated mains current				
	$I_{N, AC}$	[A]		1.20
Output voltage				
	U_{out}	[V]		DC 22.5 ...28.5
Rated current				
	I_N	[A]		10.0
Dimensions				
	h x b x t	[mm]		130 x 85 x 125
Mass				
	m	[kg]		1.24





Controller p500

Accessories



CAN bus connector

The connector is used to connect the CAN to inverters which are provided with a Sub-D connection for the CAN bus. An integrated CAN terminating resistor can be switched on/off. Internal spring terminals make the use of special mounting tools superfluous. The switch setting can be read from two sides.

Mode		Features	Product key
CAN bus connector: Node		<ul style="list-style-type: none"> • Sub-D, 90° • Screw terminals 	EPM-T950
CAN bus connector: Terminating		<ul style="list-style-type: none"> • Sub-D, 90° • Screw terminals • Integrated terminating resistor 	EPM-T951
CAN bus connector: Straight		<ul style="list-style-type: none"> • Sub-D, 180° • Screw terminals • Switchable terminating resistor 	EPM-T952
CAN bus connector: Switch		<ul style="list-style-type: none"> • Sub-D, 90° • Spring-loaded terminal • Switchable terminating resistor 	EWZ0046

3.5

Protection films

Mode		Features	Product key
10.9 cm (4.3")		<ul style="list-style-type: none"> • Protection of the surface against chemicals and mechanical damages (Packaging unit: 2 pieces) 	EPCZMFD8
17.8 cm (7")			EPCZMFD9
26.4 cm (10.4")			EPCZMFD4

MC cards

In addition to the available standard interfaces, the Controllers can be optionally extended with further fieldbuses. This enables a very universal implementation into the machine control. These fieldbuses can be ordered or retrofitted as MC cards.

Mode	Features	Product key
MC card	• 2 x CAN interface (MC-CAN2)	EPCZEBKM9
	• 1 x PROFIBUS slave (MC-PBS)	EPCZEBKM6
	• 1 x PROFINET device (MC-PND)	EPCZEBKM8
	• 1 x RS232, RS422, RS485 (MC-ISI)	EPCZEBKMD
	• 1 x EtherNet (MC-ETH)	EPCZEBKM1

Controller p500

Accessories



3.5

Controls

Controller p300

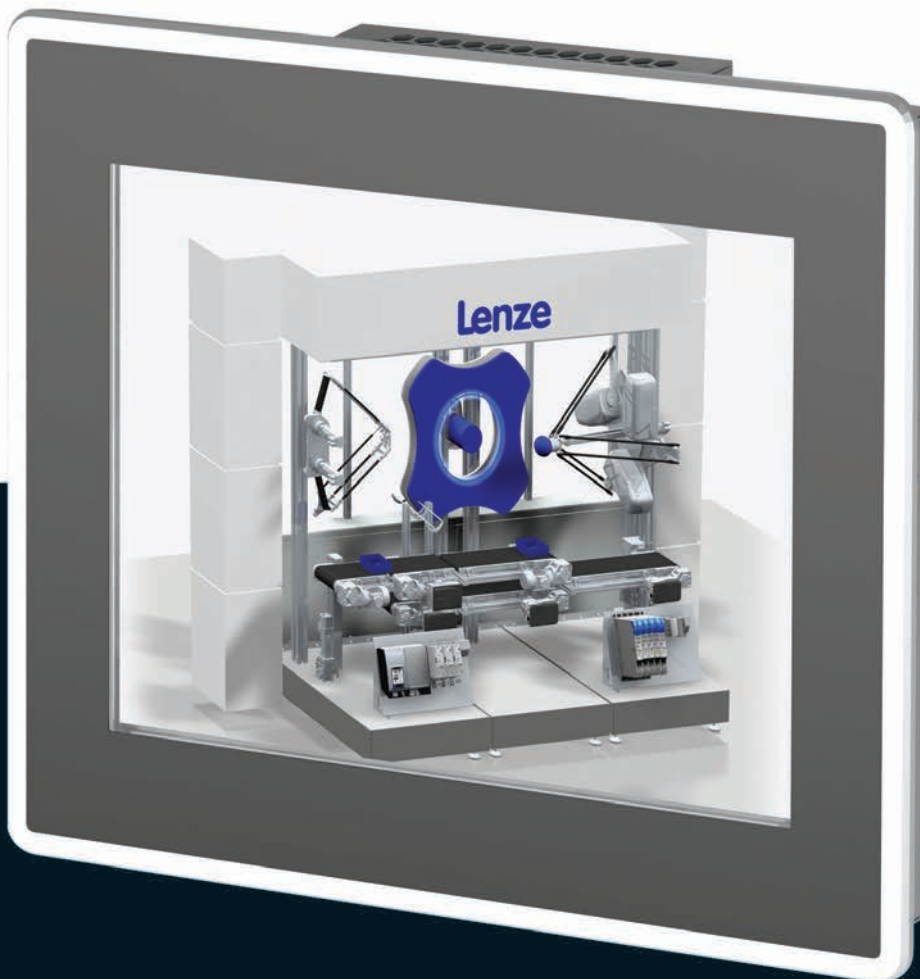

Controller p300

Contents



General information	Product key	3.6 - 4
	Equipment	3.6 - 5
	Product information	3.6 - 6
Technical data	Standards and operating conditions	3.6 - 9
	Rated data	3.6 - 11
	Dimensions	3.6 - 13
Interfaces	Connection plan	3.6 - 15
	Mains connection	3.6 - 15
Accessories	Safety Controller	3.6 - 17
	SD card and USB flash drive	3.6 - 18
	24 V power supply unit	3.6 - 18
	CAN bus connector	3.6 - 19
	Protection films	3.6 - 19

Controller p300

General information



Product key

Product

Product key

p 3 0 0

P 3 0 G A 0 0 0 F 3 G X X X - 0 2 S 3 1 0 0 0

Type

P - Panel Controller
H - HMI

Display diagonal

8 - 10.9 cm (4.3")
9 - 17.8 cm (7")
4 - 26.4 cm (10.4")

Type

3 - Standard layout
8 - Rear control cabinet installation

Option interface MC 1

0 - No
8 - MC-PND (PROFINET Device)

Operating system

C - WEC7 Core
D - WEC7 Prof

Runtime software control technology

0 - No
3 - FAST Runtime

Power tags

4 - 500 power tags
5 - 1000 power tags

3.6



Controller p300 - 10.9 cm (4.3")



Controller p300 - 17.8 cm (7")



Controller p300 - 26.4 cm (10.4")

Controller p300

General information



Equipment

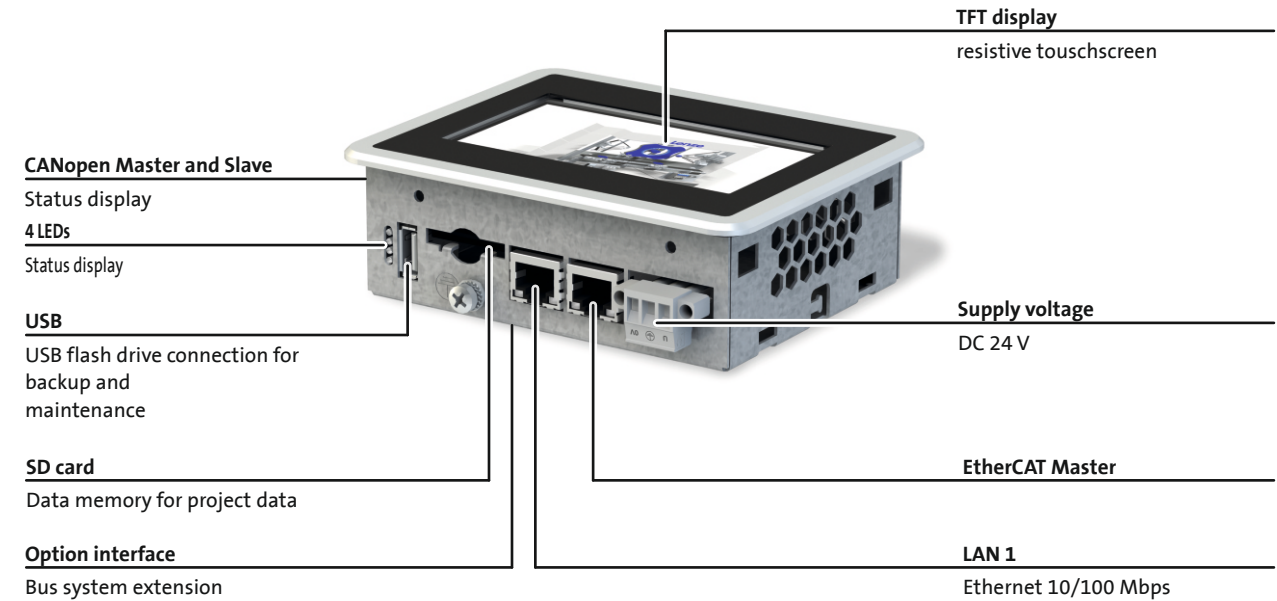

3.6

Safety topology extension

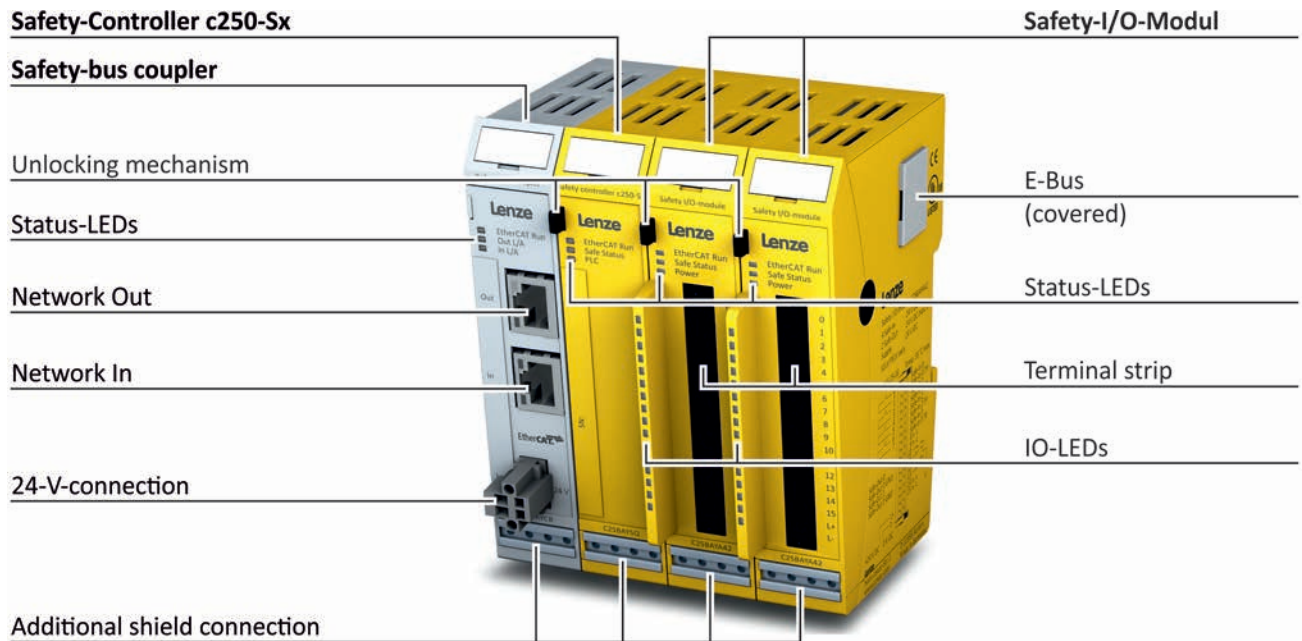

Controller p300

General information



Product information

So small, and yet so powerful!

Based on the p500 panel controller, the new p300 fits seamlessly into our platform which is built on a consistently modern system architecture.

It combines logic (PLC) and visualisation in a compact device and is ideally suited to machine applications which only require a low processing power. With the same system properties as its older brother (p500), its true strength lies in its visualisation capabilities when used as an HMI.

Highlights

- Robust industry-compliant Panel Controller available in sizes 10.9 cm (4.3"), 17.8 cm (7") and 26.4 cm (10.4")
- For basic to complex control and visualisation tasks
- Uniform engineering in all phases of the customer's machine development process
- High degree of system availability
 - Integrated UPS solution
 - Easy device replacement thanks to replaceable memory card
- No maintenance required thanks to batteryless and fanless design

Variants

The p300 device series comprises 3 variants differing in the display size and therefore in the design and dimension of the front module. The panel controllers are available with screen diagonals of 10.9 cm (4.3"), 17.8 cm (7"), and 26.4 cm (10.4"). All technical properties of the controller unit are identical in this series.

Safety topology with EtherCAT®

The Safety Controller c250-S clears the way for planning the complete drive and safety technology from one single source. The entire machine safety can be programmed with only one engineering tool, based on the PLCOpen standard - irrespective whether it is about "grey" or "yellow" control technology.

The deep integration of the functional safety into the automation system makes the engineering easier, improves the diagnostics options and reduces the number of interfaces and components.

This saves time and money and finally increases the availability and flexibility of the machine.



Operator control and process monitoring functions — p300 as HMI

The strength of the p300 lies in visualisation tasks. With the integrated VisiWinNET® visualisation system and the optional logic control system, the devices are also cost-effective and powerful complete systems for operator control and process monitoring. Thanks to tried-and-tested standard interfaces, the devices offer a variety of options for communication with the Lenze system world as well as with master controls.

For an easy dialog between people and machines.

Controller p300

General information



Product information

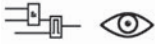

Logic (PLC) and visualisation in a single device

- Optimised for machines/modules with central motion control
- Easy engineering thanks to central data storage

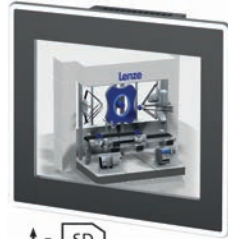

Easy to use

- Automated standard set-up and data backup via USB stick
- Easy device replacement by the pluggable SD card Application Credit 0
- Diagnostics via implemented web server or EASY Starter

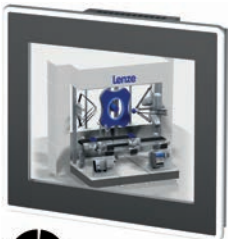

High degree of system availability

- Maintenance-free
- Fanless
- No battery

IEC 61131-3

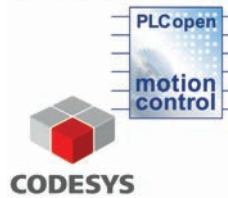

Prepared for the future thanks to compliance with industrial standards

- Programming in IEC61131-3
- PLC Designer based on CODESYS 3

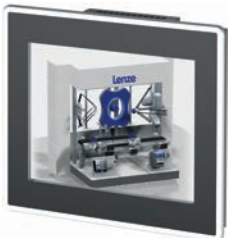

Communicative

- EtherCAT® as a fast bus system directly on board (in preparation)
- CANopen on board
- Precisely tailored by modular extension option



Variable front panel concept

- Easy customizing of the front panels (foils, smart customising)

Controller p300

General information

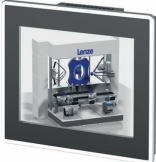

Controller p300

Technical data

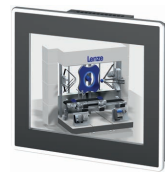

Standards and operating conditions

Mode			p300		
Controller			p300		
Display					
Screen diagonal	[cm]		10.9	17.8	26.4
	["]		4.3	7.0	10.4
Conformity					
CE			Low-Voltage Directive 2014/30/EU		
EAC			TP TC 020/2011 (TR CU 020/2011)		
Approval					
UL 508C			Process Control Equipment (File-No. E236341)		
UL/CSA			CSA C22.2 No. 61010-2-201 UL 61010-2-201		
Degree of protection					
EN 60529			IP65 (front) IP20 (back)		
NEMA 250			Type 4		
Climatic conditions					
Storage (EN 60721-3-1)			1K3 (Temperature: -5 °C ... +45 °C)		
Transport (EN 60721-3-2)			2K3 (temperature: -25 °C ... +70 °C)		
Operation (EN 60721-3-3)			3K3 (temperature: 0 °C ... +50 °C)	3K3 (temperature: 0 °C ... +55 °C)	
Degree of pollution					
EN 61131-2			2		
Site altitude					
Amsl	H _{max}	[m]	2000		
Vibration resistance					
Vibration (EN 61131-2)			1 g		
Mechanical shock (EN 61131-2)			15 g		
Noise emission					
EN 61000-6-4			Industrial premises		
Noise immunity					
EN 61000-4-2			ESD: Severity 3		
EN 61000-4-6			150 kHz ... 80 MHz, 10 V/m 80 % AM (1 kHz)		
EN 61000-4-3			80 kHz ... 1000 MHz, 10 V/m 80 % AM (1 kHz) 1.4 GHz ... 2.0 GHz, 3 V/m, 80 % AM (1kHz) 2.0 GHz ... 2.7 GHz, 1 V/m, 80 % AM (1kHz)		
EN 61000-4-4			Burst: Severity 3		

3.6



Standards and operating conditions

Relative humidity

3.6

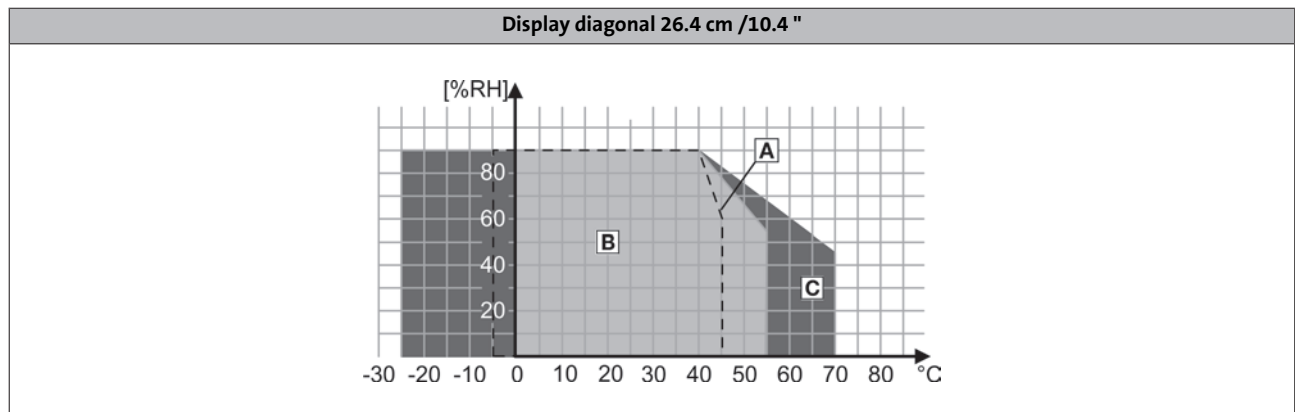
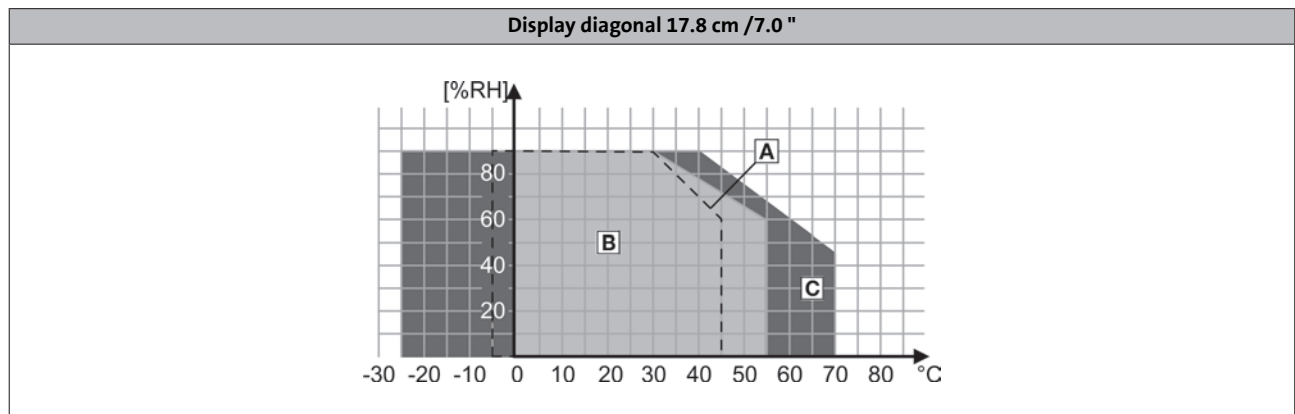
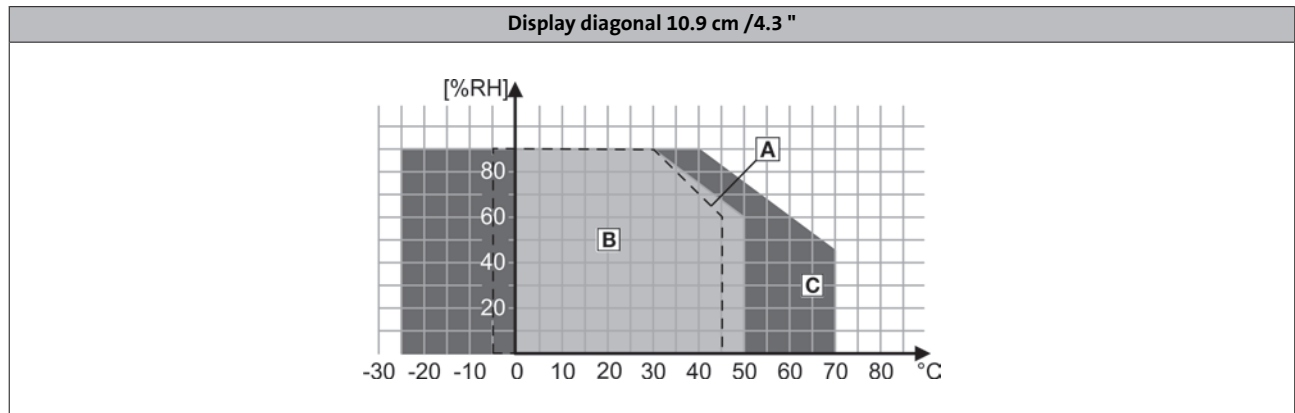



- [A] Storage
- [B] Operation
- [C] Transport

Controller p300

Technical data



Rated data

							
Mode				p300			
Controller				p300			
Display							
Screen diagonal			[cm]	10.9	17.8	26.4	
			[°]	4.3	7.0	10.4	
Display				TFT			
Design				color			
Type				Graphics			
Number of colours				262144			
Resolution				[Pixel]	480 x 272	800 x 480	800 x 600
Brightness				[cd/m ²]	400	320	400
Contrast					1 : 400		1 : 700
Operator control							
Screen				Resistive touchscreen			
Processor type							
Fanless				ARM Cortex A8800			
Storage medium							
SD card				[MB]	512		
Interfaces							
Ethernet				1			
EtherCAT Master				1			
CANopen				1			
USB				1			
Option ¹⁾				Interface connection for PROFINET-Device (MC-PND)			
Supply voltage							
DC		U _{in}	± 25 %	[V]	24		
Max. current consumption							
		I _{max}		[A]	0.85	0.90	0.95
Operating system				Windows® Embedded Compact 7			

¹⁾ In preparation.



3.6

Controller p300

Technical data



Rated data

					
Mode			p300		
Controller			p300		
Display					
Screen diagonal		[cm]	10.9	17.8	26.4
		[°]	4.3	7.0	10.4
Memory size					
Retain data		[kB]	128		
Main memory (RAM)		[MB]	512		
Min. internal flash memory		[GB]	2		
Runtime					
FAST Runtime ¹⁾			●		
Dimensions					
	h x b x t	[mm]	130 x 104 x 45	210 x 155 x 51	282 x 240 x 51
Mass					
	m	[kg]	0.53	1.10	2.10

¹⁾ Optional

3.6

Controller p300

Technical data



Dimensions

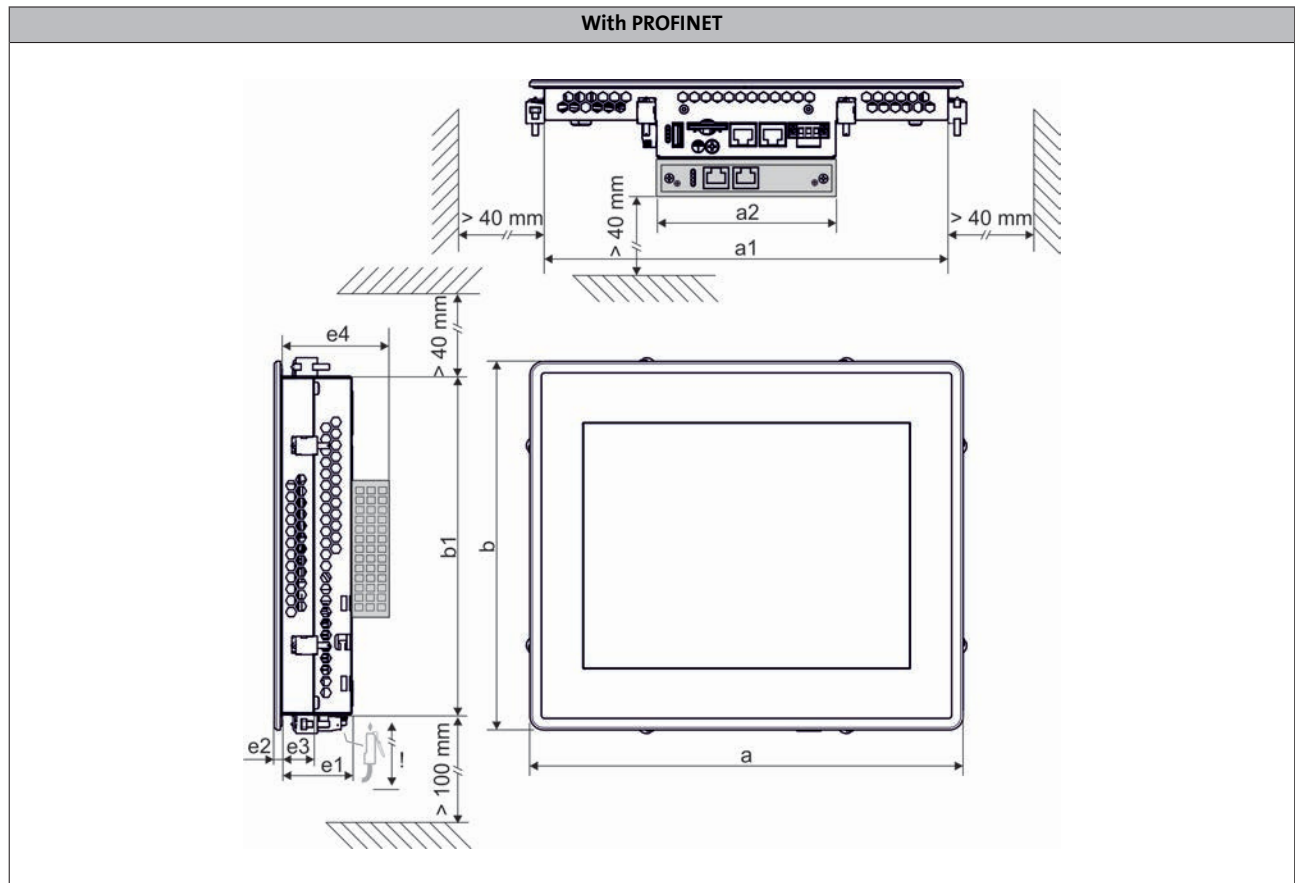

3.6

Display		Dimensions								
Screen diagonal		a	a ₁	a ₂	b	b ₁	e ₁	e ₂	e ₃	e ₄
[cm]	["]	[mm]	[mm]	[mm]	[mm]	[mm]	[mm]	[mm]	[mm]	[mm]
10.9	4.3	130	117	117	104	91.0	42.0	3.00		73.0
17.8	7.0	210	191	117	155	136	47.0	4.00	22.0	78.0
26.4	10.4	282	263	117	240	221	47.0	4.00	22.0	78.0



Connection plan

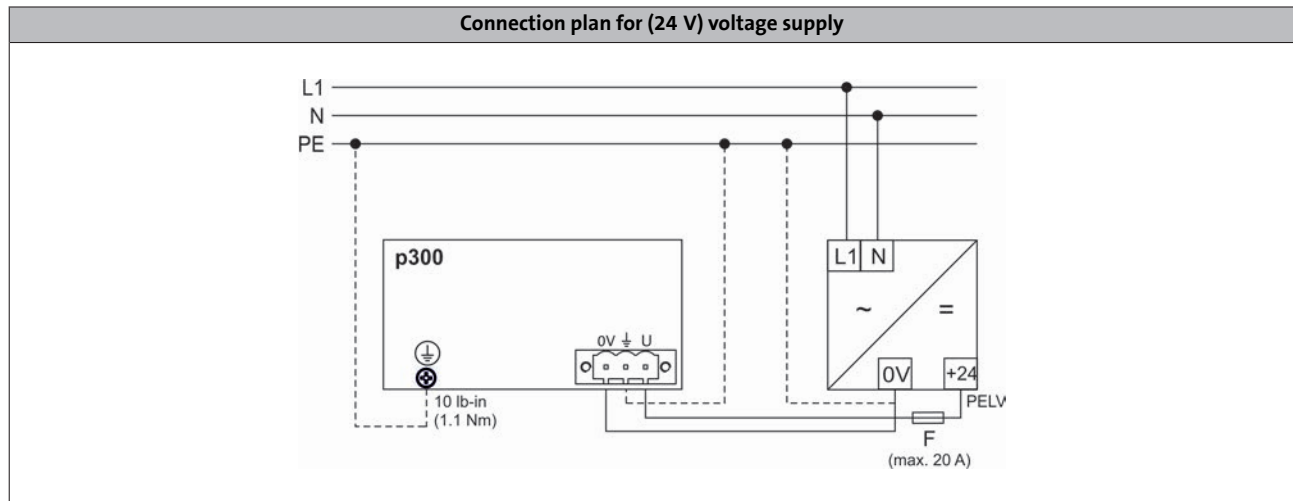

3.6

Mains connection

	Connection	Connection type	Cable type
	DC supply (24 V)	3-pole Combicon socket	Cable with Combicon-plug (cable cross-section max. 2.5 mm ²)
	PE connection	M4 (PH 2)	Separate earth conductor (1.2 ... 2.5 mm ² with ring cable lug)

Controller p300

Interfaces

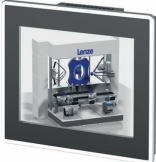

Controller p300

Accessories



Safety Controller

Safety in the system does not begin with the drives first, but at the control level.

With the expansion of the controller software to include the Safety Controller c250-S a complete automation solution is provided for safety engineering and control and drive tasks. Topped with the safety I/O module, all the safety aspects in the machine module can be evaluated. EtherCAT is used for data transfer.



Mode		Features	Product key
Safety Controller c250-S	-	<ul style="list-style-type: none"> Compact Controller c250-S for easy mounting using the DIN rail High-quality safety solution thanks to PL e/SIL 3 	C25BAYSQ
Safety bus coupler	-	<ul style="list-style-type: none"> Supported network: EtherCAT with safety-over EtherCAT (FSoE = Fail Safe over EtherCAT) 	C25BAYCB
Safety I/O module	-	<ul style="list-style-type: none"> Expansion of the Safety Controller with 4 safe inputs and 2 safe outputs 	C25BAYA42

3.6

Safety Controller	
Functions	Implementation according to PLCopen, TC 5
Equivalence / antivalence test	SF_Equivalent SF_Antivalent
Operation mode selector	SF_ModeSelector
Emergency stop, emergency off	SF_EmergencyStop
Monitoring of electro-sensitive protective equipment (ESPE)	SF_ESPE (electro-sensitive protective equipment)
Guard monitoring	SF_GuardMonitoring
Guard monitoring with locking	SF_GuardLocking
Two-hand control	SF_TwoHandControlTypeII SF_TwoHandControlTypeIII
Muting	SF_MutingSeq SF_MutingPar SF_MutingPar_2Sensors
Cyclic test of ESPE	SF_TestableSafetySensor
Enable switch	SF_EnableSwitch
Controlling safety output with standard controller and safety controller	SF_OutControl
Monitoring of feedback loop	SF_EDM (external device monitoring)

Technical data	
Rated current	240 mA via E-bus connection
DC supply voltage	5 V via E-bus connection 24 V via safety bus coupler
Dimensions h x w x d	120 mm x 25 mm x 90 mm
Degree of protection	IP20

Controller p300

Accessories



SD card and USB flash drive

SD cards and USB flash drives are available for data storage and data backups.

- ▶ A SD card is part of the scope of supply of the controller.
- ▶ SD card without Application Credit.

Mode		Features	Product key
Application Credit 0		<ul style="list-style-type: none"> • 512 MB 	
USB flash drive		<ul style="list-style-type: none"> • 1 GB 	EPCZEMUS4
		<ul style="list-style-type: none"> • 4 GB 	EPCZEMUS6

3.6

24 V power supply unit

An external power supply unit is also available as an alternative for powering the controller's control electronics.



24 V power supply unit

Rated data

Product key			EZV2400-000
Rated voltage			
AC	$U_{N, AC}$	[V]	230
Rated mains current			
	$I_{N, AC}$	[A]	1.20
Output voltage			
	U_{out}	[V]	DC 22.5 ...28.5
Rated current			
	I_N	[A]	10.0
Dimensions			
	h x b x t	[mm]	130 x 85 x 125
Mass			
	m	[kg]	1.24





Controller p300

Accessories



CAN bus connector

The connector is used to connect the CAN to inverters which are provided with a Sub-D connection for the CAN bus. An integrated CAN terminating resistor can be switched on/off. Internal spring terminals make the use of special mounting tools superfluous. The switch setting can be read from two sides.

Mode		Features	Product key
CAN bus connector: Node		<ul style="list-style-type: none"> • Sub-D, 90° • Screw terminals 	EPM-T950
CAN bus connector: Terminating		<ul style="list-style-type: none"> • Sub-D, 90° • Screw terminals • Integrated terminating resistor 	EPM-T951
CAN bus connector: Straight		<ul style="list-style-type: none"> • Sub-D, 180° • Screw terminals • Switchable terminating resistor 	EPM-T952
CAN bus connector: Switch		<ul style="list-style-type: none"> • Sub-D, 90° • Spring-loaded terminal • Switchable terminating resistor 	EWZ0046

3.6

Protection films

Mode		Features	Product key
10.9 cm (4.3")		<ul style="list-style-type: none"> • Protection of the surface against chemicals and mechanical damages (Packaging unit: 2 pieces) 	EPCZMFD8
17.8 cm (7")			EPCZMFD9
26.4 cm (10.4")			EPCZMFD4

Controller p300

Accessories



I/O System 1000



I/O System 1000

Contents



General information	Product information	3.7 - 4
	Functions and features	3.7 - 6
	Compiling an I/O system	3.7 - 9
Technical data	General	3.7 - 10
	Standards and operating conditions	3.7 - 10
	Bus coupler	3.7 - 11
	Rated data	3.7 - 11
	Digital inputs	3.7 - 15
	Rated data	3.7 - 15
	Digital outputs	3.7 - 18
	Rated data	3.7 - 18
	RELAY	3.7 - 23
	Rated data	3.7 - 23
	Analog inputs	3.7 - 25
	Rated data	3.7 - 25
	Analog outputs	3.7 - 27
	Rated data	3.7 - 27
	Temperature measurement	3.7 - 28
	Rated data	3.7 - 28
	Measuring range	3.7 - 29
	Counter	3.7 - 30
	Rated data	3.7 - 30
	Technology modules	3.7 - 34
	Rated data	3.7 - 34
	Encoder evaluation	3.7 - 36
	Rated data	3.7 - 36
Power supply modules	3.7 - 37	
Rated data	3.7 - 37	
Potential distribution modules	3.7 - 38	
Rated data	3.7 - 38	
Accessories	Bracket for shield bus	3.7 - 39
	CAN bus connector	3.7 - 39
	Labelling strip	3.7 - 40

I/O System 1000

General information



Product information



Permanent wiring

- 2-part concept: base module and electronic module
- The electronics can be replaced during maintenance work without touching the wiring
- The item designation remains on the base module
- Codes prevent the incorrect module type from being connected



>Fast diagnostics

- Clearly structured labelling and diagnostics concept
- Bright LEDs are easy to see, even in poorly illuminated control cabinets
- One LED and one labelling field is clearly assigned to each channel



Easy connection

- Circuit diagram and connection plan printed directly on the module
- Side: detailed view
- Front: simplified view, also visible when the modules have been installed



Integrated shield connection

- Brackets are available as accessories for shield buses
- Direct installation of standard 10 x 3 busbars on the I/O station
- Shield connection possible with standard cable attachments and shield clamps



No tools required for installation

- Direct snap-in installation on the DIN rail
- Individual module or entire station can be fitted
- Complete blocks can subsequently be attached to the DIN rail
- The release levers remain open, allowing complete stations to be fitted and removed



Scalable supply concept

- The main supply is a fixed component of the bus coupler and supplies both the electronics and the I/O level
- Additional I/O supply available as an option, in the event that more than 10 A output current is required
- Additional I/O supply and electronic supply available as an option for extremely large station structures
- Each new I/O supply forms a separate potential area

I/O System 1000

General information



Functions and features

Bus coupler module

Mode	Product key
Bus coupler	
CANopen	EPM-S110
PROFIBUS	EPM-S120
EtherCAT	EPM-S130
PROFINET	EPM-S140
DeviceNet	EPM-S150
Modbus TCP/IP	EPM-S160

- Scope of supply: bus coupler module, including power supply module

Input and output modules

3.7

Mode	Abbreviated designation	Product key
Digital I/O		
Inputs	DI 2, DC 24 V	EPM-S200
	DI 4, DC 24 V	EPM-S201
	DI 8, DC 24 V	EPM-S202
	DI 4, DC 24 V	EPM-S203
	DI 2, 2 μ s, DC 24 V	EPM-S207
	DI 2, NPN, DC 24 V	EPM-S204
	DI 4, NPN, DC 24 V	EPM-S205
	DI 8, NPN, DC 24 V	EPM-S206
Outputs	DO 2, DC 24 V, 0.5 A	EPM-S300
	DO 4, DC 24 V, 0.5 A	EPM-S301
	DO 8, DC 24 V, 0.5 A	EPM-S302
	DO 2, DC 24 V, 2 A	EPM-S306
	DO 4, DC 24 V, 2 A	EPM-S309
	DO2, DC 24 V, 1 μ s	EPM-S310
	DO 2, NPN, DC 24 V, 0.5 A	EPM-S303
	DO 4, NPN, DC 24 V, 0.5 A	EPM-S304
	DO 8, NPN, DC 24 V, 0.5 A	EPM-S305
RELAY	Relay 2, AC 230 V, 3 A	EPM-S308

- Scope of supply: I/O compound module (base module + electronic module)

I/O System 1000

General information



Functions and features

Input and output modules

Mode		Product key
Analog I/O	Abbreviated designation	
Inputs	AI 2, 12-bit, 0 to 10 V	EPM-S400
	AI 4, 12-bit, 0 to 10 V	EPM-S401
	AI 2, 12-bit, 0/4 to 20 mA	EPM-S402
	AI 4, 12-bit, 0/4 to 20 mA	EPM-S403
	AI 2, 16-bit, -10 V to 10 V	EPM-S406
	AI 2, 16-bit, 0/4 to 20 mA	EPM-S408
Outputs	AO 2, 12-bit, 0 to 10 V	EPM-S500
	AO 4, 12-bit, 0 to 10 V	EPM-S501
	AO 2, 12-bit, 0/4 to 20 mA	EPM-S502
	AO 4, 12-bit, 0/4 to 20 mA	EPM-S503

- Scope of supply: I/O compound module (base module + electronic module)

Function modules

Mode		Product key
Product	Abbreviated designation	
Temperature measurement	AI 4, 16-bit, resistor	EPM-S404
	AI 2, 16-bit, Thermo	EPM-S405
Counter	Counter 1, DC 24 V	EPM-S600
	Counter 2, DC 24 V	EPM-S601
	Counter 1, DC 5 V	EPM-S602
	Counter 2, DC 24 V	EPM-S603
Encoder evaluation	SSI	EPM-S604
Technology modules	PWM	EPM-S620
	RS -232	EPM-S640
	RS -422/485	EPM-S650

- Scope of supply: I/O compound module (base module + electronic module)

I/O System 1000

General information



Functions and features

Power supply modules

Mode		Product key
Product	Abbreviated designation	
Power supply modules	Power BC	EPM-S700
	Power DC 24 V	EPM-S701
	Power DC 24 V / 24 V	EPM-S702

- ▶ Scope of supply for EPM-S700: electronic module
Scope of supply for EPM-S701 to 702: I/O compound module
(base module + electronic module)

Potential distribution modules

Mode		Product key
Product	Abbreviated designation	
Potential distribution modules	Supply 8 x DC 24 V	EPM-S910
	Supply 8 x DC 0 V	EPM-S911
	Supply 4 x DC 24 V / 0 V	EPM-S912

3.7

I/O System 1000

General information



Compiling an I/O system

The I/O system 1000 can be used to create a very individual, tailored system for the most diverse of applications. A total of up to 64 I/O modules can be integrated.

Operation with bus coupler

The bus couplers are used to connect the I/O system to a control via a bus system, in which a 24V power supply module, the so-called main power supply, is integrated.

Properties of the power supply unit:

- 5V electronic supply of the bus coupler itself, as well as the connected modules.
Maximum output current 3 A
- 24V I/O supply for the inputs and outputs of the connected modules
Maximum output current 7 A (10 A if no UL-conformity is required in the field of deployment)

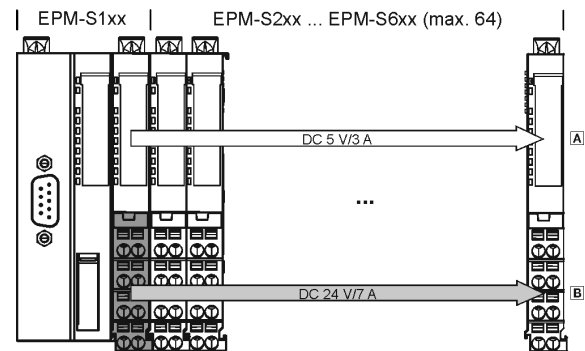

A: Electronics supply
B: I/O supply

3.7

Extension with power supply modules

In comprehensive systems, operation with just the DC supply via the bus coupler is sometimes not enough. In cases such as these, the I/O system can be extended with additional power supply modules.

Depending on which supply is insufficient, there are two different modules available:

- Power supply module EPM-S701
Additional I/O supply (7 A)
- Power supply module EPM-S702
Additional electronics supply (2 A) and I/O supply (4 A)

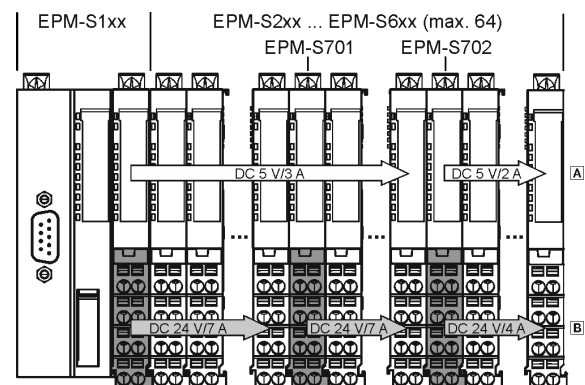

A: Electronics supply
B: I/O supply

External supply

The I/O system can also be used to supply 24V consumers. This is particularly useful when using active sensors which need to be connected using three-wire conductors. Power distribution modules EPM-S91□ which, depending on their design, provide 24 V and 0 V for connection of external sensor technology are available for this.

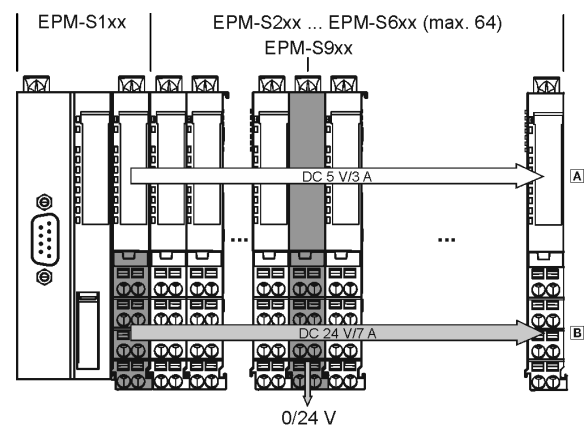

A: Electronics supply
B: I/O supply



Standards and operating conditions

Conformity			
CE			Low-Voltage Directive 2006/95/EC
EAC			TP TC 020/2011 (TR CU 020/2011)
Approval			
UL 508C			Programmable Controller (File-No. E343358)
Degree of protection			
EN 60529			IP20
Climatic conditions			
Storage (EN 60068-2-14)			Temperature: -25 °C ... +70 °C
Transport (EN 60068-14)			Temperature: -25 °C ... +70 °C
Operation (EN 61131-2)			Temperature: 0 °C ... +60 °C
Site altitude			
Amsl	H _{max}	[m]	3000
Vibration resistance			
Vibration (EN 60068-2-6)			1 g
Mechanical shock (EN 60068-2-27)			15 g
Noise emission			
EN 61000-6-4			Limit class A
Noise immunity			
EN 61000-4-2			ESD: Severity 3
EN 61000-4-6			150 kHz ... 80 MHz, 10 V/m 80% AM (1 kHz)
EN 61000-4-3			80 kHz ... 1000 MHz, 10 V/m 80% AM (1 kHz)
EN 61000-4-4			Burst: Severity 3
EN 61000-4-5			Surge: Severity 3
Insulation resistance			
IEC 61131-2			Overvoltage category III Above 2000 m amsl overvoltage category II
Insulation voltage to reference earth/PE			
EN 61800-5-1	U _{AC}	[V]	500
Electrical isolation			
			500 V between I/O supply, electronic supply and fieldbus
Protective insulation of control circuits			
EN 61800-5-1			Safe mains isolation: double/reinforced insulation

I/O System 1000

Technical data - Bus coupler



Rated data

					
Product key			EPM-S110	EPM-S120	EPM-S130
Mode					
Bus coupler			CANopen	PROFIBUS	EtherCAT
Rated voltage					
DC	$U_{N, DC}$	[V]	24		
Max. input current					
	$I_{in, max}$	[A]	0.95	0.90	0.95
Output current					
Backplane bus	I_{out}	[A]	3		
I/O supply	I_{out}	[A]	7 ¹⁾		
Output voltage					
I/O supply	U_{out}	[V]	24		
Max. number of I/O modules			64		
Diagnostics					
Voltage supply			Supply OK / fuse defective		
Bus diagnostics			RUN-LED as per CANopen Ready for operation System error	Ready for operation System error	
Fusing			Via power supply module		
Communication					
Communication profile			CANopen, DS301 V4.02	PROFIBUS-DP-V0 PROFIBUS-DP-V1	EtherCAT (CoE)
Node			Slave		
Baud rate					
	b		10 kbps ... 1 Mbps	9.6 kbps ... 12 Mbps	100 Mbps
Number of bus nodes			127	With repeaters: 125 Without repeaters: 32	Max. 65535
Number of PDOs			16 Rx / 16 Tx	244 bytes	4 kbytes
Device description file			EDS	GSE	XML (Modular Device Profile MDP)

¹⁾ Can used up to 10 A without UL-approval.

I/O System 1000

Technical data - Bus coupler



Rated data

Product key			EPM-S110	EPM-S120	EPM-S130
Mode			CANopen	PROFIBUS	EtherCAT
Connection			Sub-D connection, 9-pin		RJ45, double
Dimensions			109 x 48 x 76.5		
Mass			0.16		
	h x b x t	[mm]			
	m	[kg]			

3.7

Product key	EPM-S110	EPM-S120	EPM-S130

I/O System 1000

Technical data - Bus coupler



Rated data

					
Product key			EPM-S140	EPM-S150	EPM-S160
Mode					
Bus coupler			PROFINET	DeviceNet	Modbus TCP/IP
Rated voltage					
DC	$U_{N, DC}$	[V]	24		
Max. input current					
	$I_{in, max}$	[A]	0.95		
Output current					
Backplane bus	I_{out}	[A]	3		
I/O supply	I_{out}	[A]	7 ¹⁾		
Output voltage					
I/O supply	U_{out}	[V]	24		
Max. number of I/O modules			64		
Diagnostics					
Voltage supply			Supply OK / fuse defective		
Bus diagnostics			Ready for operation System error		
Fusing			Via power supply module		
Communication					
Communication profile			PROFINET (RT/IRT)	DeviceNet	Modbus TCP/IP
Node					
			Device	Slave	
Baud rate					
	b		100 Mbps	500 kbps	100 Mbps
Number of bus nodes					
			255	64	
Number of PDOs					
			512 bytes	256 bytes	1 kbytes
Device description file					
			GSDML	EDS	

¹⁾ Can used up to 10 A without UL-approval.

I/O System 1000

Technical data - Bus coupler



Rated data

Product key			EPM-S140	EPM-S150	EPM-S160
Mode			PROFINET	DeviceNet	Modbus TCP/IP
Connection			RJ45, double	Pluggable terminal 5-pole	RJ45
Dimensions			109 x 48 x 76.5		
			h x b x t	[mm]	
Mass			0.16		
			m	[kg]	

3.7

Product key	EPM-S140	EPM-S150	EPM-S160

I/O System 1000

Technical data - Digital inputs



Rated data

► Positive switching

					
Product key			EPM-S200	EPM-S201	EPM-S202
Mode					
Abbreviated designation			DI 2, DC 24 V	DI 4, DC 24 V	DI 8, DC 24 V
Digital inputs					
Number			2	4	8
Input filter delay time			[ms] 3		
Connection system			1-/2-/3-wire technology	1-/2-wire technology	1-wire technology
Input level			IEC 61121-2 type 1 "0": 0 ... 5 V "1": 15 ... 28.8 V		
Wiring			PNP		
Input current					
Backplane bus		I_{in}	[mA] 55		60
Rated voltage					
DC		$U_{N,DC}$	[V] 24		
Communication					
Width in the input process image			8 bits 2 bits with bus coupler EPM-S110	8 bits 4 bits with bus coupler EPM-S110	8 bits
Parameter data (PROFIBUS/PROFINET)					
Diagnostics					
Module status			Ready for operation / error		
Signal status			1 LED per channel		
Time stamp					
Dimensions					
		h x b x t	[mm] 109 x 12.5 x 76.5		
Mass					
		m	[kg] 0.060		

3.7

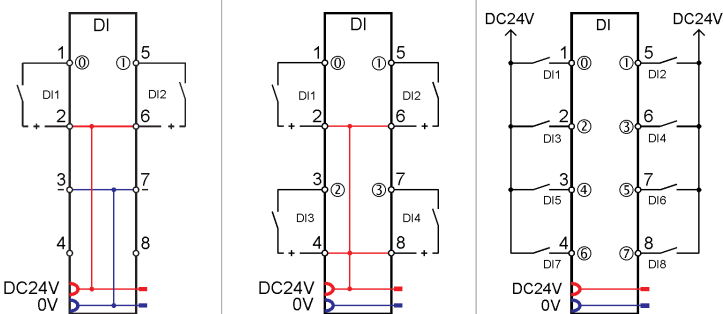
Product key			EPM-S200	EPM-S201	EPM-S202
					

I/O System 1000

Technical data - Digital inputs



Rated data

► Positive switching

				
Product key			EPM-S203	EPM-S207
Mode				
Abbreviated designation			DI 4, DC 24 V	DI 2, 2 μs, DC 24 V
Digital inputs				
Number			4	2
Input filter delay time			3	0.002 ... 3
Connection system			1-/2-/3-wire technology	
Input level			IEC 61121-2 type 1 "0": 0 ... 5 V "1": 15 ... 28.8 V	
Wiring			PNP	
Input current				
Backplane bus		I_{in} [mA]	55	85
Rated voltage				
DC		$U_{N,DC}$ [V]	24	
Communication				
Width in the input process image			8 bits 4 bits with bus coupler EPM-S110	4 ... 60 bytes
Parameter data (PROFIBUS/PROFINET)			6 bytes	
Diagnostics				
Module status			Ready for operation / error	
Signal status			1 LED per channel	
Time stamp			Yes	
Dimensions				
		h x b x t [mm]	109 x 12.5 x 76.5	
Mass				
		m [kg]	0.060	

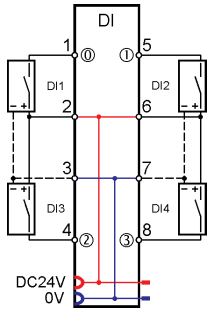
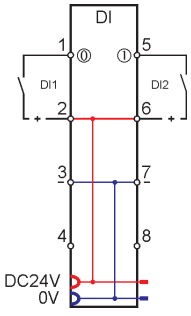
Product key			EPM-S203	EPM-S207
				

I/O System 1000

Technical data - Digital inputs



Rated data

► Negative switching

					
Product key			EPM-S204	EPM-S205	EPM-S206
Mode					
Abbreviated designation			DI 2, NPN, DC 24 V	DI 4, NPN, DC 24 V	DI 8, NPN, DC 24 V
Digital inputs					
Number			2	4	8
Input filter delay time			[ms] 3		
Connection system			1-/2-/3-wire technology	1-/2-wire technology	1-wire technology
Input level			IEC 61121-2 type 1 "0": 0 ... 5 V "1": 15 ... 28.8 V		
Wiring			NPN		
Input current					
Backplane bus	I_{in}	[mA]	60		65
Rated voltage					
DC	$U_{N,DC}$	[V]	24		
Communication					
Width in the input process image			8 bits 2 bits with bus coupler EPM-S110	8 bits 4 bits with bus coupler EPM-S110	8 bits
Diagnostics					
Module status			Ready for operation / error		
Signal status			1 LED per channel		
Time stamp					
Dimensions					
		h x b x t	[mm] 109 x 12.5 x 76.5		
Mass					
		m	[kg] 0.060		

3.7

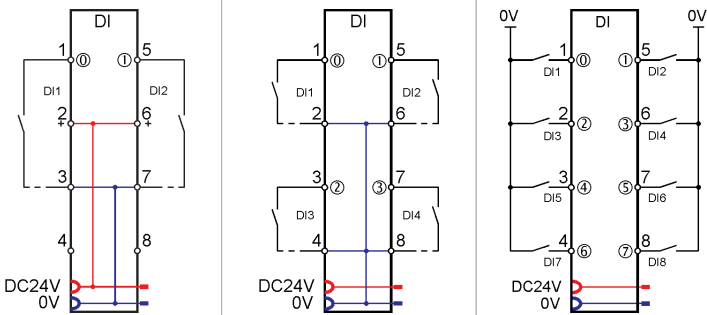
Product key			EPM-S204	EPM-S205	EPM-S206
					

I/O System 1000

Technical data - Digital outputs



Rated data

► Positive switching

					
Product key			EPM-S300	EPM-S301	EPM-S302
Mode					
Abbreviated designation			DO 2, DC 24 V, 0.5 A	DO 4, DC 24 V, 0.5 A	DO 8, DC 24 V, 0.5 A
Digital outputs					
Number			2	4	8
Output filter delay time	T	[μ s]	30 ... 175		
Connection system			1-/2-/3-wire technology	1-/2-wire technology	1-wire technology
Wiring			PNP		
Input current					
Backplane bus	I_{in}	[mA]	55		65
I/O supply	I_{in}	[mA]	5 ¹⁾	10 ¹⁾	15 ¹⁾
Output current					
per channel	I_{out}	[A]	0.50		
Rated voltage					
DC	$U_{N,DC}$	[V]	24		
Switching frequency					
Ohmic load	f_{ch}	[Hz]	1000		
Inductive load	f_{ch}	[Hz]	0.50		
Lamp load	f_{ch}	[Hz]	10.0		
Communication					
Width in the input process image					
Width in the output process image			8 bits 2 bits with bus coupler EPM-S110	8 bits 4 bits with bus coupler EPM-S110	8 bits
Parameter data (PROFIB- US/PROFINET)					

¹⁾ + load current.

I/O System 1000

Technical data - Digital outputs



Rated data

► Positive switching

					
Product key			EPM-S300	EPM-S301	EPM-S302
Mode			Ready for operation / error / overload		
Abbreviated designation			DO 2, DC 24 V, 0.5 A	DO 4, DC 24 V, 0.5 A	DO 8, DC 24 V, 0.5 A
Diagnostics			1 LED per channel		
Module status			Electronic		
Dimensions			109 x 12.5 x 76.5		
	h x b x t	[mm]			
Mass			0.060		
	m	[kg]			

3.7

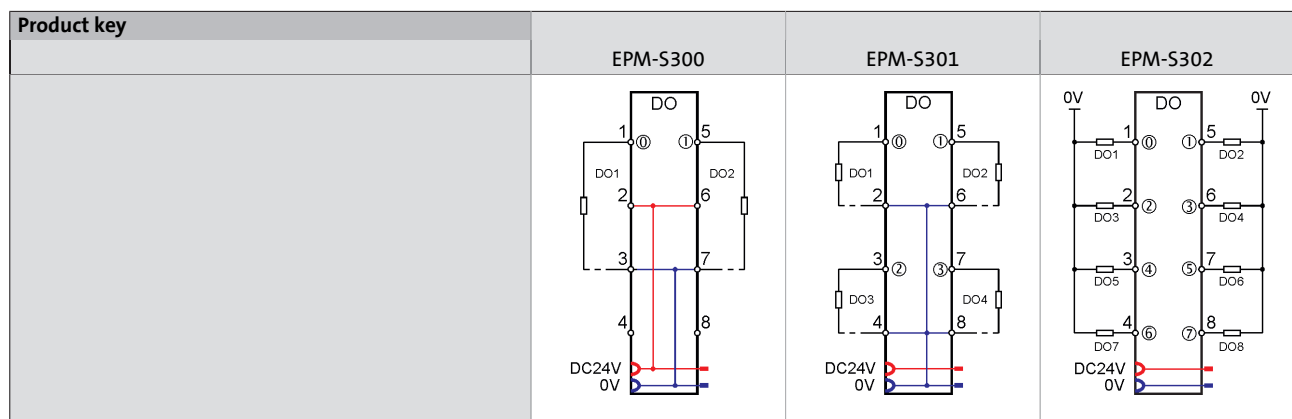

I/O System 1000

Technical data - Digital outputs



Rated data

► Positive switching

					
Product key			EPM-S306	EPM-S309	EPM-S310
Mode					
Abbreviated designation			DO 2, DC 24 V, 2 A	DO 4, DC 24 V, 2 A	DO2, DC 24 V, 1 μ s
Digital outputs					
Number			2	4	2
Output filter delay time	T	[μ s]	30 ... 175		1
Connection system			1-/2-/3-wire technology	1-/2-wire technology	
Wiring			PNP		
Input current					
Backplane bus	I_{in}	[mA]	55		85
I/O supply	I_{in}	[mA]	5 ¹⁾	10 ¹⁾	14 ¹⁾
Output current					
per channel	I_{out}	[A]	2.00 ²⁾		0.50
Rated voltage					
DC	$U_{N,DC}$	[V]	24		
Switching frequency					
Ohmic load	f_{ch}	[Hz]	1000		40000
Inductive load	f_{ch}	[Hz]	0.50		40000
Lamp load	f_{ch}	[Hz]	10.0		40000
Communication					
Width in the input process image					4 bytes
Width in the output process image			8 bits 2 bits with bus coupler EPM-S110	8 bits 4 bits with bus coupler EPM-S110	4 ... 60 bytes
Parameter data (PROFIB- US/PROFINET)					2 bytes

¹⁾ + load current.

²⁾ On the EPM-S309, the max. total current is 4 A.

I/O System 1000

Technical data - Digital outputs



Rated data

► Positive switching

Product key			EPM-S306	EPM-S309	EPM-S310
Mode			Ready for operation / error / overload		
Abbreviated designation			DO 2, DC 24 V, 2 A	DO 4, DC 24 V, 2 A	DO2, DC 24 V, 1 μ s
Diagnostics			1 LED per channel		
Module status			Electronic		
Dimensions			109 x 12.5 x 76.5		
	h x b x t	[mm]			
Mass			0.060		
	m	[kg]			

3.7

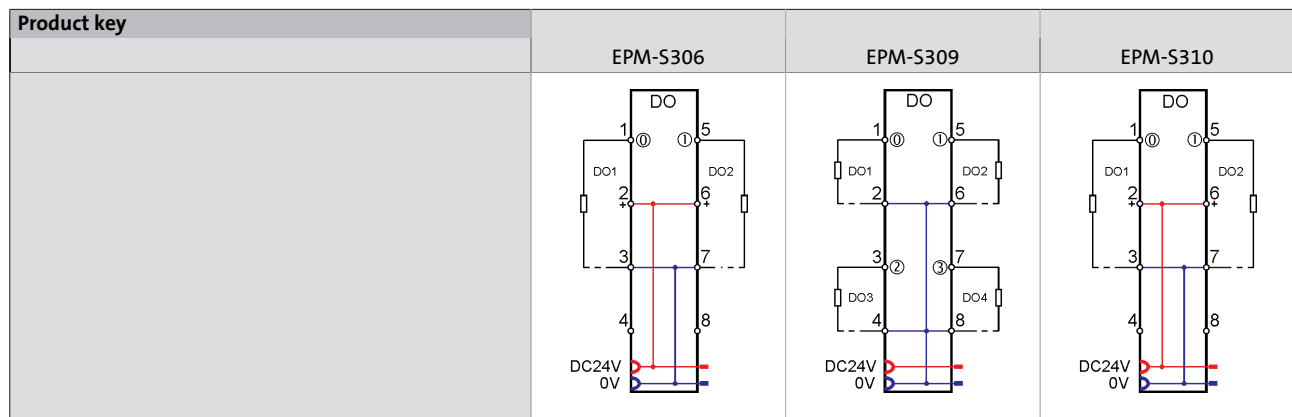

I/O System 1000

Technical data - Digital outputs



Rated data

► Negative switching

					
Product key			EPM-S303	EPM-S304	EPM-S305
Mode					
Abbreviated designation			DO 2, NPN, DC 24 V, 0.5 A	DO 4, NPN, DC 24 V, 0.5 A	DO 8, NPN, DC 24 V, 0.5 A
Digital outputs					
Number			2	4	8
Output filter delay time	T	[μ s]	30 ... 175		
Connection system			1-/2-/3-wire technology	1-/2-wire technology	1-wire technology
Wiring			NPN		
Input current					
Backplane bus	I_{in}	[mA]	60	65	70
I/O supply	I_{in}	[mA]	3 ¹⁾	5 ¹⁾	10 ¹⁾
Output current					
per channel	I_{out}	[A]	0.50		
Rated voltage					
DC	$U_{N, DC}$	[V]	24		
Switching frequency					
Ohmic load	f_{ch}	[Hz]	1000		
Inductive load	f_{ch}	[Hz]	0.50		
Lamp load	f_{ch}	[Hz]	10.0		
Communication					
Width in the output process image			8 bits 2 bits with bus coupler EPM-S110	8 bits 4 bits with bus coupler EPM-S110	8 bits

¹⁾ + load current.

I/O System 1000

Technical data - Relay



Rated data

► Negative switching

					
Product key			EPM-S303	EPM-S304	EPM-S305
Mode			Ready for operation / error / overload		
Abbreviated designation			DO 2, NPN, DC 24 V, 0.5 A	DO 4, NPN, DC 24 V, 0.5 A	DO 8, NPN, DC 24 V, 0.5 A
Diagnostics			1 LED per channel		
Module status			Electronic		
Dimensions			109 x 12.5 x 76.5		
	h x b x t	[mm]			
Mass			0.060		
	m	[kg]			

3.7

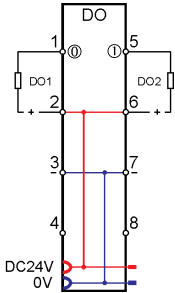
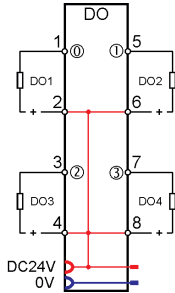
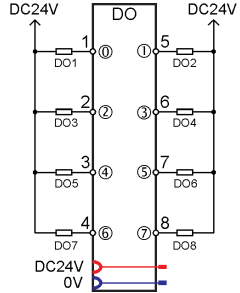
Product key	EPM-S303	EPM-S304	EPM-S305
			

¹⁾ + load current.



Rated data

Product key			EPM-S308
Mode			Relay 2, AC 230 V, 3 A
Abbreviated designation			
Relay outputs			
Number			2
Contact			NO contact
Input current			
Backplane bus	I_{in}	[mA]	55
Rated voltage			
DC	$U_{N,DC}$	[V]	30
AC	$U_{N,AC}$	[V]	230
Output current			
per channel	I_{out}	[A]	3.00
Switching frequency			
Ohmic load	f_{ch}	[Hz]	100
Communication			
Width in the output process image			8 bits 2 bits with bus coupler EPM-S110
Diagnostics			
Module status			Ready for operation / error
Signal status			1 LED per channel
Dimensions			
	h x b x t	[mm]	109 x 12.5 x 76.5
Mass			
	m	[kg]	0.060

Product key		EPM-S308

3.7

I/O System 1000

Technical data - Analog inputs



Rated data

					
Product key			EPM-S400	EPM-S401	EPM-S402
Mode					
Abbreviated designation			AI 2, 12-bit, 0 to 10 V	AI 4, 12-bit, 0 to 10 V	AI 2, 12-bit, 0/4 to 20 mA
Analog inputs					
Number			2	4	2
Voltage	U_{DC}	[V]	0 ... 10		
Current	I	[mA]	0 ... 20 4 ... 20		
Input filter limit frequency			1.00		
Resolution			12 bits		
Usage error limit			± 0.3		± 0.3 at 0 ... 20 mA ± 0.5 at 4 ... 20 mA
Basic error limit (at 25 °C)			± 0.2		± 0.2 at 0 ... 20 mA ± 0.3 at 4 ... 20 mA
A/D conversion time	T	[ms]	4 (all channels)	8 (all channels)	4 (all channels)
Input current					
Backplane bus	I_{in}	[mA]	70		
I/O supply	I_{in}	[mA]	15		
Rated voltage					
DC	$U_{N,DC}$	[V]			
Communication					
Width in the input process image			4 bytes	8 bytes	4 bytes
Parameter data (PROFIBUS/PROFINET)			6 bytes	8 bytes	6 bytes
Diagnostics					
Module status			Ready for operation / error		
Signal status			1 LED per channel		
Dimensions					
	$h \times b \times t$	[mm]	109 x 12.5 x 76.5		
Mass					
	m	[kg]	0.060		

3.7

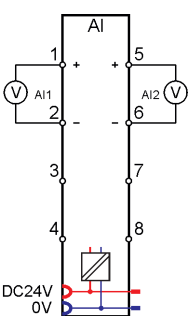
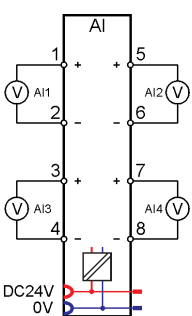
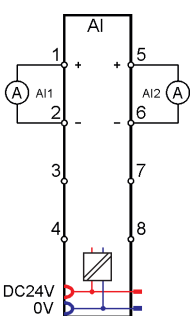
Product key	EPM-S400	EPM-S401	EPM-S402
			

I/O System 1000

Technical data - Analog inputs



Rated data

					
Product key			EPM-S403	EPM-S406	EPM-S408
Mode					
Abbreviated designation			AI 4, 12-bit, 0/4 to 20 mA	AI 2, 16-bit, -10 V to 10 V	AI 2, 16-bit, 0/4 to 20 mA
Analog inputs					
Number			4	2	
Voltage				-10 ... 10	
Current			0 ... 20 4 ... 20		0 ... 20 4 ... 20
Input filter limit frequency			1.00 [kHz]		
Resolution			12 bits		
Usage error limit			± 0.3 at 0 ... 20 mA ± 0.5 at 4 ... 20 mA		
Basic error limit (at 25 °C)			± 0.2 at 0 ... 20 mA ± 0.3 at 4 ... 20 mA		
A/D conversion time			8 (all channels) [ms]		
Input current					
Backplane bus			70 [mA]	60	
I/O supply			15 [mA]	20	15
Rated voltage					
DC			$U_{N,DC}$ [V]		
Communication					
Width in the input process image			8 bytes	4 bytes	
Parameter data (PROFIBUS/PROFINET)			8 bytes	20 bytes	
Diagnostics					
Module status			Ready for operation / error		
Signal status			1 LED per channel		
Dimensions					
h x b x t [mm]			109 x 12.5 x 76.5		
Mass					
m [kg]			0.060		

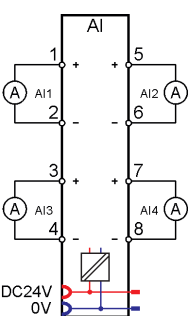
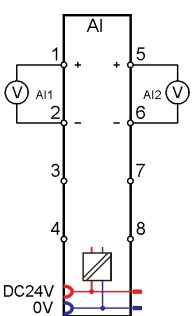
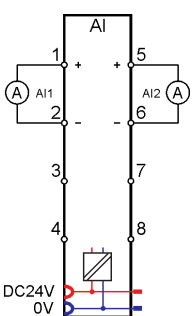
Product key	EPM-S403	EPM-S406	EPM-S408
			

I/O System 1000

Technical data - Analog outputs



Rated data

						
Product key			EPM-S500	EPM-S501	EPM-S502	EPM-S503
Mode						
Abbreviated designation			AO 2, 12-bit, 0 to 10 V	AO 4, 12-bit, 0 to 10 V	AO 2, 12-bit, 0/4 to 20 mA	AO 4, 12-bit, 0/4 to 20 mA
Analog outputs						
Number			2	4	2	4
Voltage	U_{DC}	[V]	0 ... 10			
Current	I	[mA]	0/4 ... 20			
Resolution			12 bits			
Usage error limit			± 0.3		± 0.4 at 0 ... 20 mA ± 0.5 at 4 ... 20 mA	
Basic error limit (at 25 °C)			± 0.2		± 0.2 at 0 ... 20 mA ± 0.3 at 4 ... 20 mA	
D/A conversion time			T [ms] 2 (all channels)			
Input current						
Backplane bus			I_{in} [mA] 80			
I/O supply			35		55	95
Rated voltage						
DC			$U_{N, DC}$ [V]			
Communication						
Width in the input process image			4 bytes	8 bytes	4 bytes	8 bytes
Parameter data (PROFIBUS/PROFINET)			8 bytes	10 bytes	8 bytes	10 bytes
Diagnostics						
Module status			Ready for operation / error			
Signal status			1 LED per channel (overload, short circuit, parameter entry error)			
Dimensions						
			h x b x t [mm] 109 x 12.5 x 76.5			
Mass						
			m [kg] 0.060			

3.7

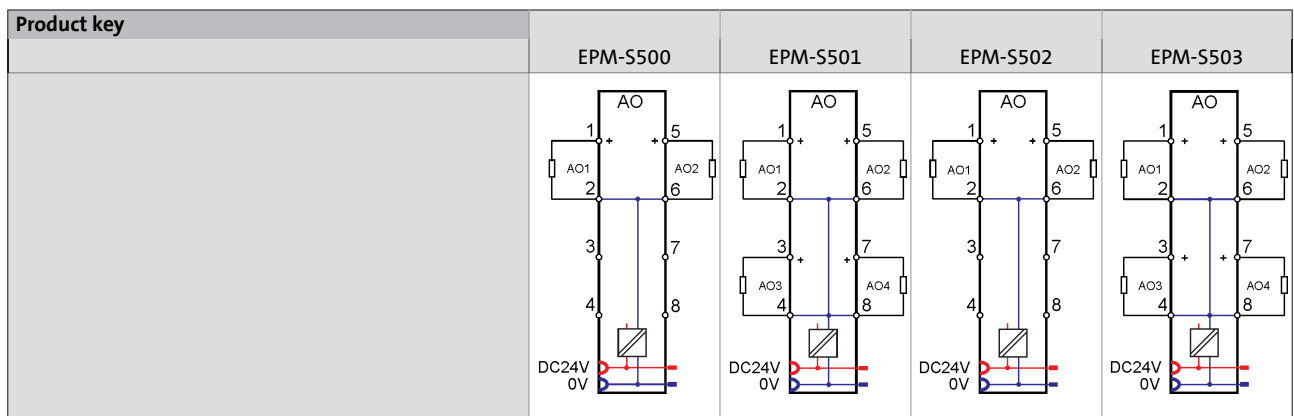



Rated data

				
Product key			EPM-S404	EPM-S405
Mode				
Abbreviated designation			AI 4, 16-bit, resistor	AI 2, 16-bit, Thermo
Analog inputs				
Number			4 / (2)	2
Voltage			U_{DC} [V]	
Resolution			16 bits	
Usage error limit			± 0.4	$\geq \pm 1.5^{1)}$
Basic error limit (at 25 °C)			[K]	
			[K]	$\geq \pm 1.0^{1)}$
A/D conversion time			T	[ms]
Connection system			2-wire technology (3-/4-wire technology)	
Input current				
Backplane bus			I_{in}	[mA]
I/O supply			I_{in}	[mA]
Temperature sensor				
			Resistor PT100, PT1000 NI100, NI1000 NI120	Thermocouple type: Thermocouple type: J, K, N, R, S, T, B, C, E, L
Communication				
Width in the input process image			8 bytes	4 bytes
Parameter data (PROFIB- US/PROFINET)			34 bytes	22 bytes
Diagnostics				
Module status			Ready for operation / error	
Signal status			1 LED per channel	
Dimensions				
			h x b x t	[mm]
Mass			m	[kg]
			109 x 12.5 x 76.5	
			0.060	

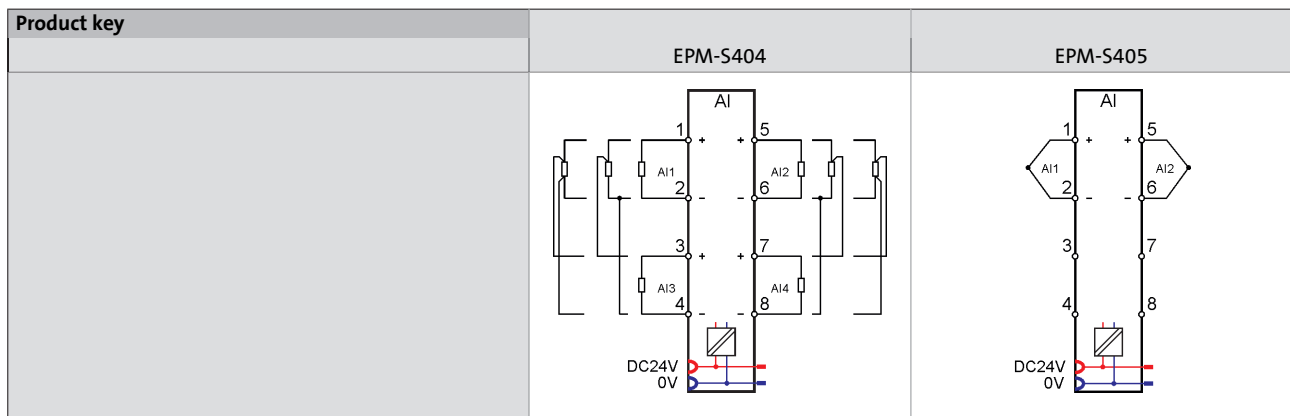

¹⁾ Dependent on the sensor and interference frequency suppression.

²⁾ Dependent on the configuration and filter settings.



Measuring range

Product key			EPM-S404	EPM-S405
Sensor measuring range				
PT100	T	[°C]	-200 ... 850	
PT1000	T	[°C]	-200 ... 850	
NI100	T	[°C]	-60 ... 250	
NI1000	T	[°C]	-60 ... 250	
Resistor	R	[Ω]	60/600/3000/6000	
Thermocouple type B	T	[°C]		0 ... 1820
Thermocouple type C	T	[°C]		0 ... 2315
Thermocouple type E	T	[°C]		-270 ... 1000
Thermocouple type J	T	[°C]		-210 ... 1200
Thermocouple type K	T	[°C]		-270 ... 1372
Thermocouple type L	T	[°C]		-200 ... 900
Thermocouple type N	T	[°C]		-270 ... 1300
Thermocouple type R	T	[°C]		-50 ... 1769
Thermocouple type S	T	[°C]		-50 ... 1769
Thermocouple type T	T	[°C]		-270 ... 400
Voltage	U _{DC}	[mV]		-80 ... 80



Rated data

					
Product key				EPM-S600	EPM-S601
Mode					
Abbreviated designation				Counter 1, DC 24 V	Counter 2, DC 24 V
Digital inputs					
Number				1	2
Input level				HTL	
Input filter limit frequency				[kHz] 100	
Counter width				[Bit] 32	
Counting frequency				[kHz] 400	
Digital outputs					
Number				1	
Input current					
Backplane bus				I_{in}	[mA] 75
I/O supply				I_{in}	[mA] 20 ¹⁾ 15 ¹⁾
Output current					
per channel				I_{out}	[A] 0.50
Rated voltage					
DC				$U_{N,DC}$	[V] 24
Communication					
Width in the input process image				12 bytes	
Width in the output process image				10 bytes	12 bytes
Parameter data (PROFIB-US/PROFINET)				21 bytes	42 bytes

¹⁾ + encoder power consumption.



Rated data

				
Product key			EPM-S600	EPM-S601
Mode			Counter 1, DC 24 V	Counter 2, DC 24 V
Abbreviated designation			Counter 1, DC 24 V	Counter 2, DC 24 V
Diagnostics			Ready for operation / error	
Module status			1 LED per counter input	
Signal status			1 LED per control input	
			1 LED per output	
Counter function			Read, set Latch function	Read, set
Alarm function			Yes	
Control inputs			Latch, reset, gate	
Dimensions			109 x 12.5 x 76.5	
	h x b x t	[mm]	109 x 12.5 x 76.5	
Mass			0.060	
	m	[kg]	0.060	

3.7

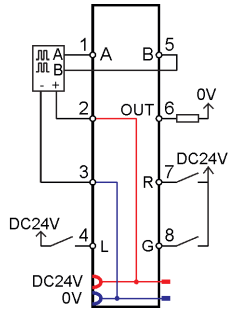
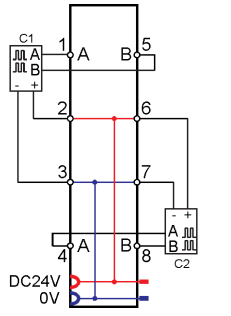
Product key		EPM-S600	EPM-S601
			



Rated data

					
Product key				EPM-S602	EPM-S603
Mode					
Abbreviated designation				Counter 1, DC 5 V	Counter 2, DC 24 V
Digital inputs					
Number				1	2
Input level				TTL	HTL
Input filter limit frequency				[kHz]	100
Counter width				[Bit]	32
Counting frequency				[kHz]	400
Digital outputs					
Number					
Input current					
Backplane bus				I_{in} [mA]	75
I/O supply				I_{in} [mA]	20 ¹⁾
Output current					
per channel				I_{out} [A]	
Rated voltage					
DC				$U_{N,DC}$ [V]	
Communication					
Width in the input process image				8 bytes	12 bytes
Width in the output process image				10 bytes	4 bytes
Parameter data (PROFIB- US/PROFINET)				22 bytes	8 bytes

¹⁾ + encoder power consumption.



Rated data

				
Product key			EPM-S602	EPM-S603
Mode			Counter 1, DC 5 V	Counter 2, DC 24 V
Abbreviated designation			Counter 1, DC 5 V	Counter 2, DC 24 V
Diagnostics			Ready for operation / error	
Module status			1 LED per counter input	
Signal status			1 LED per control input	
			1 LED per output	
Counter function			Read, set	Read
Alarm function			Yes	
Control inputs			Reset	
Dimensions			109 x 12.5 x 76.5	
	h x b x t	[mm]		
Mass			0.060	
	m	[kg]		

3.7

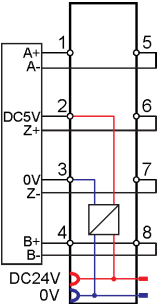
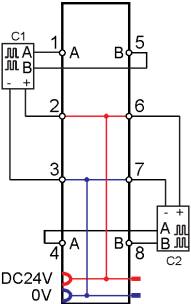
Product key		EPM-S602	EPM-S603
			



Rated data

					
Product key			EPM-S620	EPM-S640	EPM-S650
Mode					
Abbreviated designation			PWM	RS -232	RS -422/485
Outputs					
Number			2		
Level				RS 232	RS 422 / 485
Delay time					
	T	[μ s]	1		
Switching frequency					
	f _{ch}	[kHz]	20		
Input current					
Backplane bus			I _{in}	[mA]	85
I/O supply			I _{in}	[mA]	15 ¹⁾
Output current					
per channel			I _{out}	[A]	0.50
Rated voltage					
DC			U _{N, DC}	[V]	24
Communication					
Hardware handshake				RTS/CTS	
Protocols				ASCII, STX/ETX, 3964 (R)	
Width in the input process image			4 bytes	max. 60 Byte	
Width in the output process image			12 bytes	max. 60 Byte	
Parameter data (PROFIB-US/PROFINET)			8 bytes	17 bytes	
Max. baud rate					
	b	[kBit/s]		115	

¹⁾ + load current.

3.7

I/O System 1000

Technical data - Technology modules



Rated data

					
Product key			EPM-S620	EPM-S640	EPM-S650
Mode			PWM	RS -232	RS -422/485
Abbreviated designation					
Diagnostics			Ready for operation / error		
Module status			1 LED per channel		
Signal status			1 TxD LED, 1 RxD LED		
Short-circuit strength			Electronic		
Dimensions			109 x 12.5 x 76.5		
			h x b x t	[mm]	
Mass			0.060		
			m	[kg]	

3.7

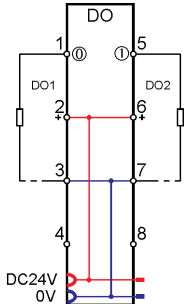
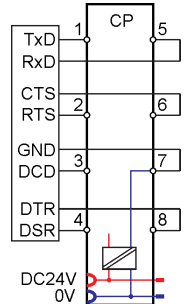
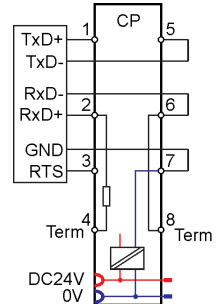
Product key	EPM-S620	EPM-S640	EPM-S650
			



Rated data

			
Product key			EPM-S604
Mode			SSI
Abbreviated designation			SSI
Inputs			
Number			1
Level			RS 422
Frequency	f_{in}	[kHz]	12 ... 6000
Input current			
Backplane bus	I_{in}	[mA]	70
I/O supply	I_{in}	[mA]	30
Rated voltage			
DC	$U_{N,DC}$	[V]	24
Communication			
Width in the input process image			6 bytes
Parameter data (PROFIBUS/PROFINET)			33 bytes
Diagnostics			
Module status			Ready for operation / error
Signal status			1 LED per encoder input
Evaluation function			3 comparisons, 2 limit values
Dimensions			
	h x b x t	[mm]	109 x 12.5 x 76.5
Mass			
	m	[kg]	0.060

Product key		EPM-S604



3.7

I/O System 1000

Technical data - Power supply modules



Rated data

					
Product key			EPM-S700	EPM-S701	EPM-S702
Mode			Power BC	Power DC 24 V	Power DC 24 V / 24 V
Abbreviated designation			Power BC	Power DC 24 V	Power DC 24 V / 24 V
Rated voltage			24		
DC	$U_{N, DC}$	[V]	24		
Supply voltage			24		
Electronics	U_{in}	[V]	DC 24 (20.4 ... 28.8)		DC 24 (20.4 ... 28.8)
Output current					
Backplane bus	I_{out}	[A]			
I/O supply	I_{out}	[A]	7 ¹⁾		4
Electrical isolation			500 V between I/O supply, electronic supply and fieldbus	not connected to the I/O supply voltage of the modules to the left	not connected to the I/O supply voltage of the modules to the left 500 V between I/O supply and electronic supply
Diagnostics			Supply OK / fuse defective		
Voltage supply			Supply OK / fuse defective		
Fusing			Internal		
Polarity reversal protection			Present		
Dimensions					
	h x b x t	[mm]	56 x 12.5 x 62	109 x 12.5 x 76.5	
Mass					
	m	[kg]	0.030	0.060	

3.7

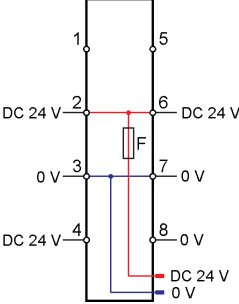
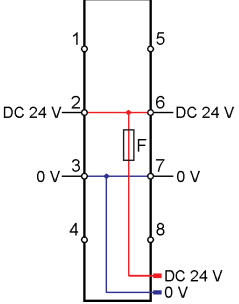
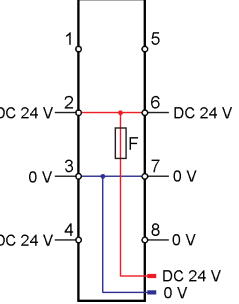
Product key	EPM-S700	EPM-S701	EPM-S702
			

¹⁾ Can used up to 10 A without UL-approval.

I/O System 1000

Technical data - Potential distribution modules



Rated data

					
Product key			EPM-S910	EPM-S911	EPM-S912
Mode					
Abbreviated designation			Supply 8 x DC 24 V	Supply 8 x DC 0 V	Supply 4 x DC 24 V / 0 V
Rated voltage					
DC	$U_{N, DC}$	[V]	24	0	0 24
Rated current					
	I_N	[A]	10.0		
Dimensions					
	h x b x t	[mm]	109 x 12.5 x 53		
Mass					
	m	[kg]	0.050		

3.7

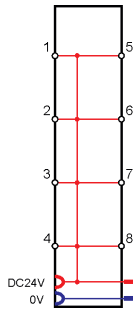
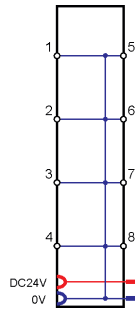
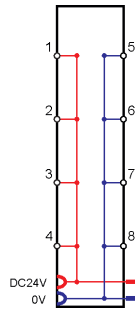
Product key		EPM-S910	EPM-S911	EPM-S912
				







Bracket for shield bus

Standard 10 x 3 busbars can be connected directly to the I/O system using the bracket for shield buses. The shield connection with standard cable attachments and shield clamps can be used.

Mode		Features	Product key
Bracket for shield bus		<ul style="list-style-type: none"> Installation of standard metal rails for shield connections directly on the module (VPE 10 pieces) 	EPM-S900

CAN bus connector

The connector is used to connect the CAN to inverters which are provided with a Sub-D connection for the CAN bus. An integrated CAN terminating resistor can be switched on/off. Internal spring terminals make the use of special mounting tools superfluous. The switch setting can be read from two sides.

Mode		Features	Product key
CAN bus connector: Node		<ul style="list-style-type: none"> Sub-D, 90° Screw terminals 	EPM-T950
CAN bus connector: Terminating		<ul style="list-style-type: none"> Sub-D, 90° Screw terminals Integrated terminating resistor 	EPM-T951
CAN bus connector: Straight		<ul style="list-style-type: none"> Sub-D, 180° Screw terminals Switchable terminating resistor 	EPM-T952
CAN bus connector: Switch		<ul style="list-style-type: none"> Sub-D, 90° Spring-loaded terminal Switchable terminating resistor 	EWZ0046

I/O System 1000

Accessories



Labelling strip

Mode		Features	Product key
Labelling strip		<ul style="list-style-type: none">• DIN A4 white, precut Material: PET (water and oil resistant) Printing using a standard laser printer 102 labelling strips per sheet (VPE 10 sheets)	EPM-S990

13530934

Lenze SE
Hans-Lenze-Straße 1
D-31855 Aerzen
Phone: +49 (0)5154 82-0
Telefax: +49 (0)5154 82 28 00

www.Lenze.com

Lenze