

PositionServo

Compact and Powerful Servo Controllers



Flexible, simple, economical



MotionView[®]
OnBoard

Lenze

Commitment to Simplicity

By making the PositionServo easy to install, set up and program, we provide the ideal motor control solution for both OEM designers and electrical system engineers. An innovative and removable EPM memory chip allows instant programming of multiple drives either before or after installation, and the simple, intuitive front panel display facilitates on-site operation.

Commitment to Quality

From product design to manufacture, service and training, quality is at the foundation of Lenze's corporate philosophy. A quality product is built of superior materials by highly skilled personnel equipped with state-of-the-art instruments. And a quality product is backed by expert training, knowledgeable sales representatives and experienced repair personnel. Continuous life cycle improvement fueled by our pledge to our Customers drives our technology forward. We feel so strongly about quality that each of our products is backed with a two-year warranty.

Commitment to Innovation

We pride ourselves on delivering products to the market that are designed to meet specific customer needs. Our broad portfolio of innovative products covers very simple variable speed applications through complex motion control. Each product is positioned so that our customers pay only for the level of technology their particular application requires. The PositionServo provides both the basic torque control of a simple servo drive and the full programmability of a high-level motion controller.

Commitment to Technical Support

Experienced engineers are on hand to help customers at all levels solve their problems and find the best solutions for their applications. End users can also be assured that Lenze is always there throughout the life cycle of its products. Technical info, literature and manuals are available from our website or the worldwide network of Lenze's branches and certified distributors.

Commitment to Performance

Each Lenze product is in a class by itself when it comes to performance. We are not satisfied with average performance. The PositionServo derives its smooth performance from a very low torque ripple, quick settling time, 64-bit indexing and more. The PositionServo did not reach the marketplace until it outperformed our competitors and exceeded our own rigorous performance requirements. By using the most innovative components, we are able to provide this level of performance at a great value.

Our Promise

At Lenze it is not good enough to deliver on part of a promise. All of our products including the PositionServo deliver the entire package: Value, Quality, Innovation, Simplicity and Performance.

Lenze





Digital Synchronous (Brushless) Servo Motor Control



Looking to bridge that gap between sophisticated control and ease-of-use? Now you can get all of the high-end servo performance in a simple-to-use package. For centralized or decentralized servo control, look no further than the PositionServo.

	Power	Control	I/O	Feedback	Communications	Software
	0.4 - 7.5 kW @240VAC	Velocity	12 digital inputs	Encoder	Ethernet TCP/IP	MotionView OnBoard
	0.8 - 7.5 kW @480VAC	Torque	5 digital outputs	Resolver	Modbus TCP/IP	
		Position	2 analog inputs		EtherNet/IP	
			1 analog output		MODBUS RTU (RS-485 PPP)	
					CANopen	
					DeviceNet	
					PROFIBUS DP	



PositionServo Contents

Table of Contents	4
PositionServo	5
Introduction	6
Specifications	7
Command Sets	8
MotionView Software	9
Dimensions	10
Pin Assignments	11
Motors	12
MCS Series	13
MCS Specifications	15
MCS Speed Torque Curves	17
MCS Dimensions	38
MD Series	44
MD Specifications	45
MD Speed Torque Curves	46
MD Dimensions	49
Options	54
Cables	62
EMC Emissions Standards	70



PositionServo with programming capability, & even more features

PositionServo Servo drive/controller

The PositionServo is the one drive that has it all. From basic torque control to full programmability, you choose your level of control.

As a distributed drive/controller solution, avoid all of the costly cables and connections and put the power of the motion controller in the same package as the drive.

The PositionServo can perform along with the most high-level motion controllers, but with a simple-to-use interface and clean Ethernet connection.

If a centralized control scheme is preferred; the PositionServo will outperform most torque or velocity amplifiers. It is also packed with many features, all this for a great price!



Model 940: Encoder-based PositionServo (E94P)
Model 941: Resolver-based PositionServo (E94R)

Powerful Innovation

When do I use the PositionServo?

- For torque, velocity and step & direction control.
 - When you are sending your drive a +/- 10V or Step & Direction signal.
- If you have a ratio following application.
 - When your axis is following an encoder signal.
- For high performing distributed control.
 - When you want a motion controller and drive in one compact package.
- If you want ONE product that can do it all!
 - The PositionServo can operate as a basic drive or a stand-alone fully programmable drive/controller.





PositionServo Features

Motion Control Features

- 64-bit indexing/positioning (incremental, absolute, registered, or segmented moves)
- Linear or S-Curve accel and decel
- AutoTuning and “Real-time” Oscilloscope
- Free program examples

Drive Features

- Torque, velocity and position control
- Electronic gearing
- UL, cUL, CE(LVD & EMC)
- ISO13849-1 safety standard (optional)
- Two-year warranty

Inputs/Outputs

- 11 Programmable + 1 dedicated digital input
- 4 Programmable + 1 dedicated digital output
- 2 Programmable analog inputs
- 1 Programmable analog output

Communication Features

- Free MotionView OnBoard
- RJ-45 Standard Ethernet Modbus TCP/IP, Ethernet IP
- Optional DeviceNet, RS485 PPP or Modbus RTU slave, CANopen, PROFIBUS-DP

Power Features

Standard Drives

- 80 – 528 VAC input
- 2 – 18 Amps continuous rms current
- 300% peak current

Doubler Drives

- When operating at 120VAC, Doubler Drives can run 240VAC motors at full speed.

Feedback Options

- Integrated Encoder
- Integrated Resolver
- Optional Second Encoder Module

Compatible Motors

- MCS Series
- Third party AC permanent magnet synchronous (brushless) motors
- Encoder or resolver feedback

MotionView[®] OnBoard

All configuration and programming software is INSIDE the drive. Software is always with you, when you need it.



EPM • Electronic Programming Module - Removable Memory

The EPM is the drive's memory (programs and parameters). The EPM saves time and money. It's as easy as 1, 2, 3...

1. Create your program and parameters in your first drive.
2. Use the EPM Programmer to make multiple copies of the EPM.
3. Insert the copied EPMs into your non-programmed drives, and they are instantly programmed.

Imagine being able to fully program a servo drive in minutes.

Even with no servo experience. And with no power to the drive.

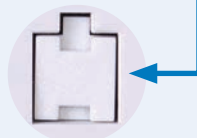



Specifications

Continuous Current (rms)	2A	4A	6A	8A	9A	10A	12A	18A
Drive Input Voltage 80-264 VAC, 1Ø or 3Ø w/out EMC Filter*	E94_020Y2N_	E94_040Y2N_		E94_080Y2N_		E94_100Y2N_	E94_120Y2N_	E94_180T2N_
80-264 VAC, 1Ø w/integrated EMC Filter	E94_020S2F_	E94_040S2F_		E94_080S2F_		E94_100S2F_		
320-528 VAC, 3Ø w/out EMC Filter*	E94_020T4N_	E94_040T4N_	E94_060T4N_		E94_090T4N_			
45-264 VAC Input, 1Ø 240 VAC Max Output w/out EMC Filter	E94_020S1N_	E94_040S1N_						
Input Frequency	48 - 62 Hz							
24V External Input (Keep Alive)	24VDC +/-20%							
* External Filter Options	Footprint E94ZF04T4A1	Footprint E94ZF07T4A1	Sidemount E94ZF10T4A1	Footprint E94ZF15T4A1	Sidemount E94ZF12T4A2	Footprint E94ZF15T4A2	Sidemount (1Ø) E94ZF24S2A1	
Drive Output								
Continuous Power @ 240VAC	800 Watts	1.7 kW		3.3 kW		4.2 kW	5.0 kW	7.5 kW
Continuous Power @ 480VAC	1.7 kW	3.3 kW	5.0 kW		7.5 kW			
Peak Current (rms) Overload**	6 Amps	12 Amps	18 Amps	24 Amps	27 Amps	30 Amps	36 Amps	54 Amps
**Peak Current (rms) Capability	Adjustable up to 300% X continuous current (rms) rating @ 8 kHz for 2 sec Adjustable up to 250% X continuous current (rms) rating @ 16 kHz for 2 sec							
Performance	Encoder-based Drive Accuracy: ± 1 Encoder Count Resolver-based Drive Accuracy: ± 1.32 Arc-Minutes (14-bit resolution) Commutation: Sinusoidal							
Servo Output								
Torque Operation Mode	Reference: ± 10VDC, 12-bit; scalable Torque Range: 100:1 Update rate: 65 µs							
Velocity Operation Mode	Reference: ± 10VDC, 12-bit; scalable Update rate: 512 µs							
Position Operation Mode	Reference: 0 to 2 MHz, scalable master to reference ratio Minimum Pulse Width: 500 nanoseconds Update rate: 512 µs							
Inputs/Outputs	11 Programmable Digital Inputs 1 Dedicated Digital Input-Enable 4 Programmable Digital Outputs 1 Dedicated Digital Output-Ready 2 Analog Inputs 1 Analog Output							
	5-24VDC, optically isolated 5-24VDC, optically isolated 5-24VDC @ 100mA, optically isolated open collector 5-24VDC @ 100mA, optically isolated open collector +/- 10V differential, 12-bit ± 10V single-ended, 10-bit							
Feedback	Encoder Input Resolver Input							
	Up to 2MHz 12 – bit resolution							
Communications	Standard Optional							
	RJ-45 Standard Ethernet, Modbus TCP/IP, Ethernet IP DeviceNet, RS485 PPP or Modbus RTU Slave, CANopen, PROFIBUS-DP							
Standards	UL, cUL, CE(LVD & EMC), CTick ISO13849-1 Safety Standard (optional)							



Command Sets

Below is an example list of some of the extensive command set available on the PositionServo.

KEYWORD	Description
ASSIGN	Assign Input As Index Bit
DEFINE	Define name
DISABLE	Turns servo OFF
DO/UNTIL	Do/Until
ENABLE	Enables servo
END	END program
EVENT	Starts Event handler
ENDEVENT	END of Event handler
EVENT ON/OFF	Turn events on or off
EVENTS ON/OFF	Globally Enables/disables events
FAULT	User generated fault
GOTO	Go To Label
GOSUB	Go To subroutine
HALT	Halt the program execution
HOME	Initiate homing routine
ICONTROL ON/OFF	Enables interface control
IF	If/Then/Else
JUMP	Jump to label from Event handler
LOADVARS	Retrieve Variables Values from EPM
MDV	Segment Move
MEMGET	Retrieve data from drive RAM
MEMSET	Store data to drive RAM
MOTION SUSPEND	Suspend Motion
MOTION RESUME	Resume Motion
MOVE	Move
MOVED	Move Distance
MOVEP	Move to Position
MOVEDR	Registered Distance Move
MOVEPR	Registered Position Move
ON FAULT/ENDFAULT	Resume Fault Handler
REGISTRATION ON	Registration On
RESUME	Resume from Fault Handler
RETURN	Return from subroutine
SEND/SEND TO	Send network variable(s) value
STOP MOTION [Quick]	Stop Motion
STOREVARS	Store Variables Values to EPM
VELOCITY ON/OFF	Velocity Mode
WAIT	Wait
WHILE/ENDWHILE	While

Pick and Place Program Example

```

;***** HEADER *****
;Title:          Pick and Place example program
;Author:         Product Manager
;Description:    This is a simple program that picks up a part,
;               moves it to a set position and place it
;***** I/O List *****
;               Input A1      - not used
;               Input A2      - not used
;               Input A3      - Enabled
;               Input A4      - not used
;               Input B1      - not used
;               Input B2      - not used
;               Input B3      - not used
;               Input B4      - not used
;               Input C1      - not used
;               Input C2      - not used
;               Input C3      - not used
;               Input C4      - not used
;
;               Output 1      - Pick Arm
;               Output 2      - Gripper
;               Output 3      - not used
;               Output 4      - not used
;***** Initialize and Set Variables *****
UNITS = 1
ACCEL = 75
DECEL = 75
MAXV = 10
APOS = 0
;***** Events *****
;               Set Events handling here
;***** Main Program *****
RESET_DRIVE:
WAIT UNTIL IN_A3 ;Wait until the Enable switch is made before continuing
ENABLE           ;Enable the Drive
PROGRAM_START:
MOVEP 0          ;Move to Pick position
OUT1 = 1        ;Turn on output 1 on to extend Pick arm
WAIT TIME 1000 ;Delay 1 sec to extend arm
OUT2 = 1        ;Turn on output 2 to Engage gripper
WAIT TIME 1000 ;Delay 1 sec to Pick part
OUT1 = 0        ;Turn off output 1 to Retract Pick arm
MOVEP 100       ;Move to Place position
OUT1 = 1        ;Turn on output 1 on to extend Pick arm
WAIT TIME 1000 ;Delay 1 sec to extend arm
OUT2 = 0        ;Turn off output 1 to Disengage gripper
WAIT TIME 1000 ;Delay 1 sec to Place part
OUT1 = 0        ;Retract Pick arm
GOTO PROGRAM_START
END
;***** Sub-Routines *****
;               Enter Sub-Routine code here
;***** Fault Handler Routine *****
;               Enter Fault Handler code here
ON FAULT
ENDFAULT

```

Command Flexibility

Every resource on the drive is accessible via a variable or flag.

Including:

- System Status/Monitoring
- I/O Status/Manipulation
- Motion Control/Monitoring
- PID Gain Sets
- Communications Set-up/Monitoring
- Homing Functionality



MotionView® OnBoard

MotionView OnBoard is your configuration and programming software that resides INSIDE the drive. Simply attach an Ethernet cable and use any web browser to get up and running.

- Plug and play servo technology
 - Software always available, whenever you need it
 - No more downloading software or installing from CDs
- Advanced debugging tools

MotionView Features:

- AutoTuning
- Statement-Based language
- “Typeless” unified, 64-bit operands
- Compiled Java-style byte code execution
- BASIC-like semantic programming
- Multipass compiler
- 64-bit Arithmetic precision
- Multi-configuration real-time oscilloscope

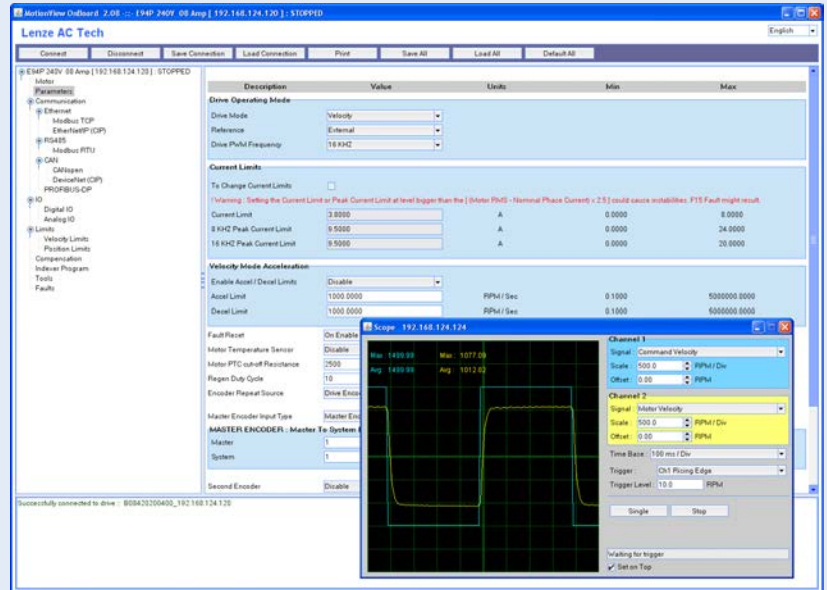

Drive Model Number Designation Code

	E94	P	020	S	2	F	E	M
Electrical Products in the 94 Series								
Drive Type:								
P = Encoder-based PositionServo Model 940								
R = Resolver-based PositionServo Model 941								
Drive Rating in Amps:								
020 = 2 Amps 090 = 9 Amps								
040 = 4 Amps 100 = 10 Amps								
060 = 6 Amps 120 = 12 Amps								
080 = 8 Amps 180 = 18 Amps								
Input Phase:								
S = Single Phase								
Y = Single or Three Phase								
T = Three Phase								
Input Voltage:								
1 = 120VAC Doubler (120V-1~ in/240V-3~ out), 240 VAC (240V-1~ in/240V-3~ out)								
2 = 200/240 VAC								
4 = 400/480 VAC								
Line Filter:								
N = No Line Filter*, Standard Heat Sink								
F = Integrated Line Filter (1 phase only), Standard Heat Sink								
Feedback:								
E = Incremental Encoder (must have E94P)								
R = Resolver (must have E94R)								
Safety Option:								
M = MotionView OnBoard, no ISO13849-1 safety compliance								
S = MotionView OnBoard with ISO13849-1 safety compliance								

* For 3-phase EMC installation, PositionServo EMC footprint/side mount filters are required.

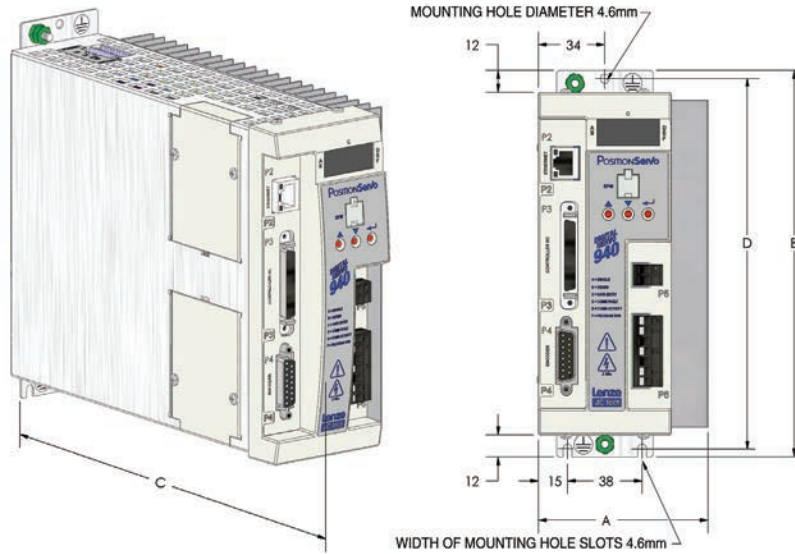

Dimensions					
Type	A (mm)	B (mm)	C (mm)	D (mm)	Weight (kg)
E94_020S1N_M	68	190	190	182	1.1
E94_040S1N_M	69	190	190	182	1.2
E94_020S2F_M	68	190	235	182	1.3
E94_040S2F_M	69	190	235	182	1.5
E94_080S2F_M	87	190	235	182	1.9
E94_100S2F_M	102	190	235	182	2.2
E94_020Y2N_M	68	190	190	182	1.3
E94_040Y2N_M	69	190	190	182	1.5
E94_080Y2N_M	95	190	190	182	1.9
E94_100Y2N_M	114	190	190	182	2.2
E94_120Y2N_M	68	190	235	182	1.5
E94_180T2N_M	68	242	235	233	2.0
E94_020T4N_M	68	190	190	182	1.5
E94_040T4N_M	95	190	190	182	1.9
E94_060T4N_M	68	190	235	182	1.4
E94_090T4N_M	68	242	235	233	2.0

PART NUMBER KEY

P = Model 940 Encoder-based drive
R = Model 941 Resolver-based drive
M = MotionView OnBoard, no ISO13849-1 safety compliance
S = MotionView OnBoard, with ISO13849-1 safety compliance

E94P020Y2NEM

E = Incremental encoder (must have E94P drive)
R = Standard resolver (must have E94R drive)

Environment Ratings	
Vibration	2 g (10 - 2000 Hz)
Ambient Operating Temperature Range	0 to 40°C
Ambient Storage Temperature Range	-10 to 70°C
Temperature Drift	0.1% per °C rise
Humidity	5 - 90% non-condensing
Altitude	1500 m/5000 ft [derate by 1% per 300m (1000 ft) above 1500m (5000 ft)]



PositionServo Pin Assignments

P3 | Controller Interface 50-pin SCSI

Pin	Name	Function
1	MA+	Master Encoder A+ / Step+ input
2	MA-	Master Encoder A- / Step- input
3	MB+	Master Encoder B+ / Direction+ input
4	MB-	Master Encoder B- / Direction- input
5	GND	Drive Logic Common
6	+5V	+5V Output (max 100mA)
7	BA+	Buffered Encoder Output: Channel A+
8	BA-	Buffered Encoder Output: Channel A-
9	BB+	Buffered Encoder Output: Channel B+
10	BB-	Buffered Encoder Output: Channel B-
11	BZ+	Buffered Encoder Output: Channel Z+
12	BZ-	Buffered Encoder Output: Channel Z-
13-19		Empty
20	AIN2+	Positive (+) of Analog signal input
21	AIN2-	Negative (-) of Analog signal input
22	ACOM	Analog common
23	AO1	Analog output
24	AIN1+	Positive (+) of Analog signal input
25	AIN1-	Negative (-) of Analog signal input
26	IN_A_COM	Digital input group A COM terminal
27	IN_A1	Digital input A1
28	IN_A2	Digital input A2
29	IN_A3	Digital input A3
30	IN_A4	Digital input A4
31	IN_B_COM	Digital input group B COM terminal
32	IN_B1	Digital input B1
33	IN_B2	Digital input B2
34	IN_B3	Digital input B3
35	IN_B4	Digital input B4
36	IN_C_COM	Digital input group C COM terminal
37	IN_C1	Digital input C1
38	IN_C2	Digital input C2
39	IN_C3	Digital input C3
40	IN_C4	Digital input C4
41	RDY+	Ready output Collector
42	RDY-	Ready output Emitter
43	OUT1-C	Programmable output #1 Collector
44	OUT1-E	Programmable output #1 Emitter
45	OUT2-C	Programmable output #2 Collector
46	OUT2-E	Programmable output #2 Emitter
47	OUT3-C	Programmable output #3 Collector
48	OUT3-E	Programmable output #3 Emitter
49	OUT4-C	Programmable output #4 Collector
50	OUT4-E	Programmable output #4 Emitter

P1 | Input Power 4-pin Removable Terminal Block

Standard Models			Doubler Models	
Pin	Name	Function	Name	Function
1	PE	Protective Earth (Ground)	PE	Protective Earth (Ground)
2	L1	AC Power in	N	AC Power Neutral (120V Doubler only)
3	L2	AC Power in	L1	AC Power in
4	L3	AC Power in (3- models only)	L2/N	AC Power in (non-doubler operation)

P2 | Communications RJ-45 Ethernet Port

P4 | Primary Feedback

Encoder 15-pin D-shell			Resolver 9-pin D-shell	
Pin	Name	Function	Name	Function
1	EA+	Channel A+ Channel A-	Ref+	Resolver reference connection
2	EA-		Ref-	
3	EB+	Channel B+ Channel B-	N/C	No connection
4	EB-		Cos+	Resolver Cosine connections
5	EZ+	Channel Z+ Channel Z-	Cos-	
6	EZ-		Sin+	Resolver Sine connections
7	GND	Ground	Sin-	
8	SHLD	Shield	PTC+	Thermal sensor
9	PWR	+5VDC	PTC-	
10	HA-	Hall A-		
11	HA+	Hall A+		
12	HB+	Hall B+		
13	HC+	Hall C+		
14	HB-	Hall B-		
15	HC-	Hall C-		

P5 | 24VDC "Keep Alive" 2-pin Removable Terminal Block

Pin	Name	Function
1	+24 VDC	Positive 24 VDC Input
2	Return	24V power supply return

P6 | Brake and DC Bus 5-pin Removable Terminal Block

Pin	Name	Function
1	B+	Positive DC Bus / Brake Resistor
2	B+	
3	BR	Brake Resistor
4	B-	Negative DC Bus
5	B-	

P7 | Motor Power 6-pin Removable Terminal Block

Pin	Name	Function
1	T1	Thermistor (PTC) Input
2	T2	Thermistor (PTC) Input
3	U	Motor Power Out
4	V	Motor Power Out
5	W	Motor Power Out
6	PE	Protective Earth (Chassis Ground)



P8 | Safety Function 6-pin Removable Terminal Block

Pin	Name	Function
1	Bypass Voltage	ISO13849-1 Bypass Voltage (+24VDC)
2	Bypass COM	ISO13849-1 Bypass Common
3	Safety Status	ISO13849-1 Safety Status
4	Safety Input1	ISO13849-1 Safety Input 1 (+24VDC to Enable)
5	Safety COM	ISO13849-1 Safety Common
6	Safety Input2	ISO13849-1 Safety Input 2 (+24VDC to Enable)

Digital Synchronous (brushless) Servo Motors

Lenze Americas offers a variety of brushless servo motors to fit your application. A variety of motors means you never have to pay for more than what you need.

Use the selection chart below to get started. Each motor is paired up with the PositionServo so you can get the perfect performance.

		
	MCS	MD
Power Range	250 W – 5 kW	250 W – 5.9 kW
Input Voltage	240/480 VAC	480 VAC
Connectors	Intercontec	Intercontec
Feedback	Resolver or Encoder	Resolver
Speed	Up to 6000 rpm	Up to 6000 rpm
Ratings	IP54, IP65	IP54, IP65
Motor Poles	8	6

Don't see the exact motor you want?

The MCS and MD motors are the premier motors to complete your PositionServo Solution. If you are looking for a different flange or cable, adding a gearbox or brake, or just want your motor painted a certain color, please contact your local Lenze Americas representative for additional or custom options.

MCS Series

Low Inertia, High Power

The MCS Series of motors are characterized by an extremely low moment of inertia and an incredibly high overload capacity. The motors are designed for high power and demanding applications. Choose from a variety of frame sizes, feedback choices and accessories to create the system that is right for you.

MCS Series Features

- Synchronous AC brushless servo motors
- 250W to 5kW Power
- 240/480 VAC
- IEC Metric-mounting flange
62mm, 89mm, 116mm
- Resolver feedback
Encoder optional (4096 PPR)
- UL, CE
- IP54
- Optional IP65
- Intercontec connectors
- 8-pole
- Optional 24VDC brake
- Two-year warranty

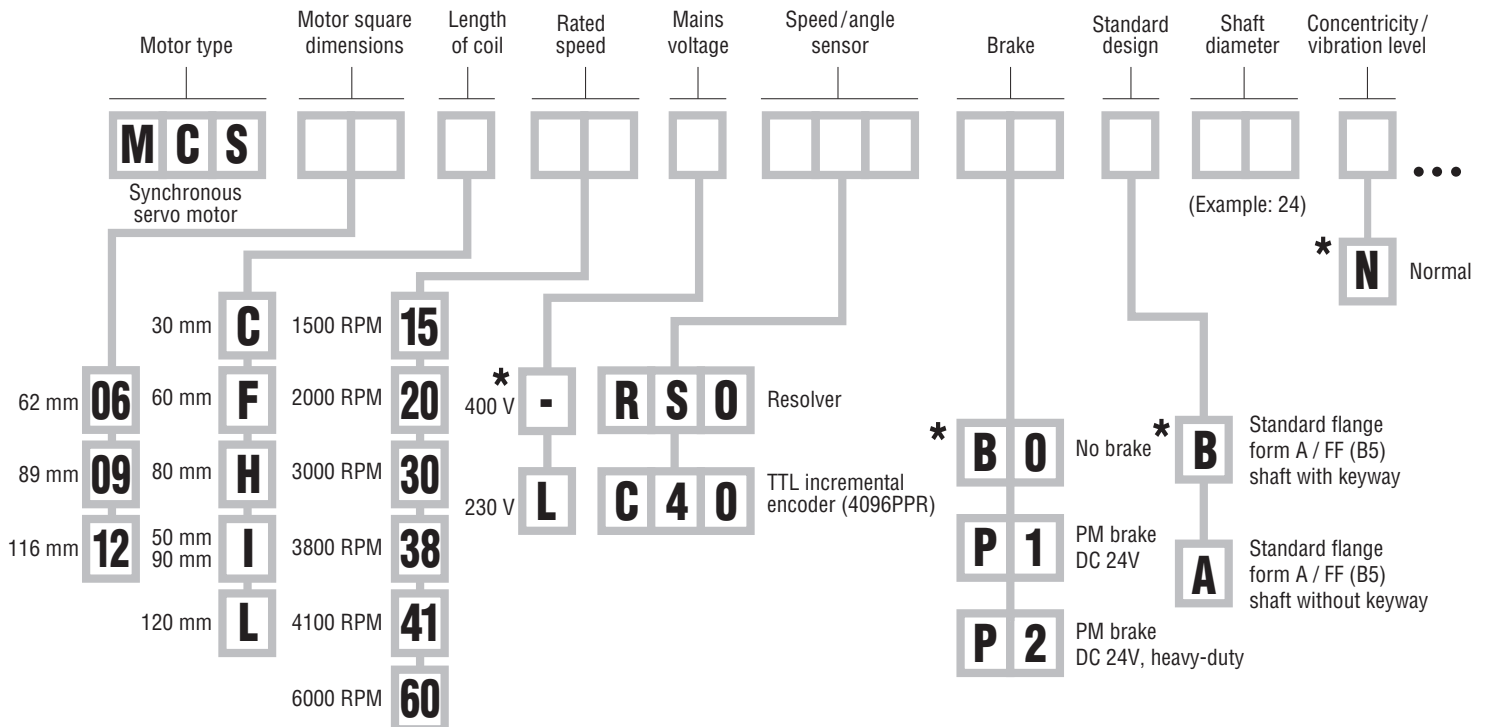

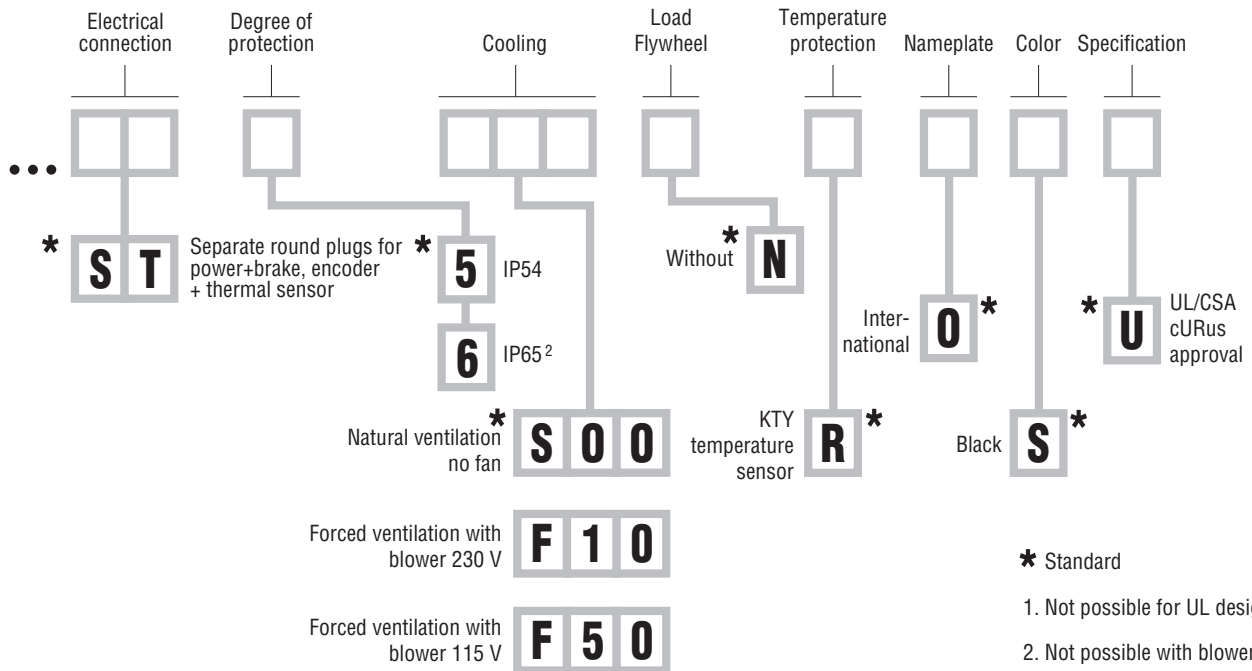
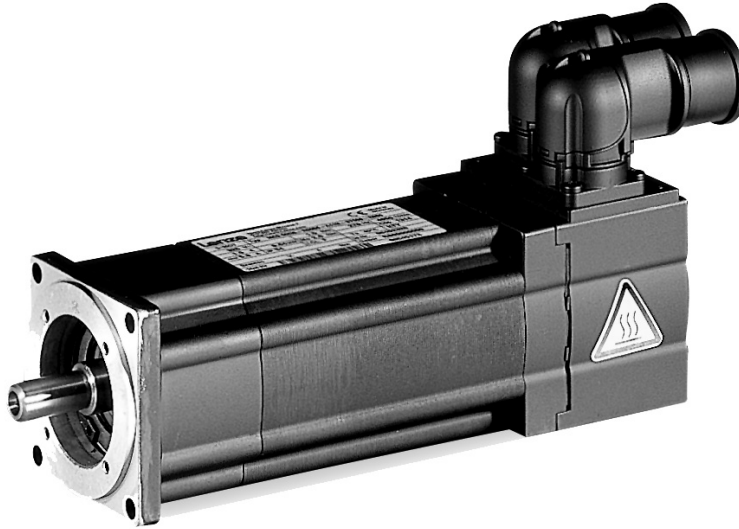



Parameter*	Units	MCS06C41L	MCS06C60L	MCS06F41L	MCS06F60L	MCS06I41L	MCS06I60L
Maximum mains voltage	VDC	340	340	340	340	340	340
Rated power	kW	0.25	0.31	0.51	0.57	0.64	0.75
Rated speed	RPM	4050	6000	4050	6000	4050	6000
Maximum speed*	RPM	8000	8000	8000	8000	8000	8000
Rated torque	N-m	0.60	0.50	1.20	0.90	1.50	1.20
	lb-In	5.31	4.42	10.62	7.96	13.27	10.62
Continuous stall torque	N-m	0.80	0.80	1.50	1.50	2.00	2.00
	lb-In	7.08	7.08	13.27	13.27	17.70	17.70
Peak torque	N-m	2.40	2.40	4.40	4.40	6.20	6.20
	lb-In	21.24	21.24	38.94	38.94	54.87	54.87
Rated current	Arms	2.5	4.0	2.9	3.4	2.9	3.6
Continuous stall current	Arms	2.5	4.3	2.9	3.8	3.1	4.2
Peak current	Arms	10.8	18.5	10.5	16.5	11.8	16.0
Torque constant at 150°C K_t	N-m/Arms	0.33	0.19	0.62	0.40	0.64	0.48
	lbs-In/Arms	2.92	1.68	5.49	3.54	5.66	4.25
Voltage constant K_e (ph-ph)	V/kRPM	21.50	12.5	34.5	22.2	38	28.5
Inductance (per phase)	mH	12.8	4.3	15.9	6.9	15.1	9.3
Resistance (per phase)	Ohm	4.0	1.45	3.7	1.5	3.1	1.7
Rotor inertia	kg - m ²	1.40E-05	1.04E-05	2.20E-05	2.20E-05	3.00E-05	3.00E-05
	lbs-In-sec ²	1.24E-04	1.24E-04	1.95E-04	1.95E-04	2.65E-04	2.65E-04
Motor weight	kg	1.8	1.8	2.2	2.2	2.9	2.9
	lb	3.97	3.97	4.85	4.85	6.39	6.39
Motor poles		8					

Parameter*	Units	MCS09D41L	MCS09D60L	MCS09F38L	MCS09F60L	MCS09H41L	MCS09H60L	MCS09L41L
Maximum bus voltage	VDC	340	340	340	340	340	340	340
Rated power	kW	1.0	1.1	1.2	1.5	1.6	1.9	1.9
Rated speed	RPM	4050	6000	3750	6000	4050	6000	4050
Maximum speed*	RPM	7000	7000	7000	7000	7000	7000	7000
Rated torque	N-m	2.30	1.80	3.10	2.40	3.80	3.00	4.5
	lb-In	20.35	15.93	27.43	21.24	33.63	26.55	39.82
Continuous stall torque	N-m	3.30	3.30	4.20	4.20	5.50	5.50	7.50
	lb-In	29.20	29.20	37.17	37.17	48.67	48.67	66.37
Peak torque	N-m	9.50	9.50	15.00	15.00	20.00	20.00	32.00
	lb-In	84.07	84.07	132.74	132.74	176.99	176.99	283.19
Rated current	Arms	4.6	7.0	5.0	7.9	6.8	8.0	8.4
Continuous stall current	Arms	5.3	10.3	6.0	10.5	8.5	12	12.4
Peak current	Arms	20	39	30	53	40	57	64
Torque constant at 150°C K_t	N-m/Arms	0.62	0.32	0.70	0.40	0.65	0.46	0.60
	lb-In/Arms	5.49	2.83	6.19	3.54	5.75	4.07	5.31
Voltage constant K_e (ph-ph)	V/kRPM	35.6	18.3	40	22.8	37.8	26.6	35.9
Inductance (per phase)	mH	6.3	1.7	6.2	2.0	4.0	2.0	2.5
Resistance (per phase)	Ohm	1.2	0.6	0.9	0.28	0.6	0.24	0.30
Rotor inertia	kg - m ²	1.10E-04	1.10E-04	1.50E-04	1.50E-04	1.90E-04	1.90E-04	2.80E-04
	in-lbs-sec ²	9.74E-04	9.74E-04	1.33E-03	1.33E-03	1.68E-03	1.68E-03	2.48E-03
Motor weight	kg	4.3	4.3	5.2	5.2	6.1	6.1	7.9
	lb	9.48	9.48	11.47	11.47	13.45	13.45	17.42
Motor poles		8						

* Motor performance does not always reflect system performance. System performance can be found in the following speed-torque curves.

Parameter*	Units	MCS12D20L	MCS12D41L	MCS12H15L	MCS12H30L	MCS12L20L
Maximum bus voltage	VDC	340	340	340	340	340
Rated power	kW	1.1	1.8	1.6	2.5	2.8
Rated speed	RPM	1950	4050	1500	3000	1950
Maximum speed*	RPM	6000	6000	6000	6000	6000
Rated torque	N-m	5.50	4.30	10.00	8.00	13.50
	lb-In	48.67	38.05	88.50	70.80	119.47
Continuous stall torque	N-m	6.4	6.4	11.4	11.4	15.0
	lb-In	56.64	56.64	100.88	100.88	132.74
Peak torque	N-m	18	18	29	29	56
	lb-In	159.29	159.29	256.64	256.64	495.58
Rated current	Arms	5.2	8.8	7.8	10.5	11.8
Continuous stall current	Arms	5.5	10.7	8.2	13.5	12.4
Peak current	Arms	20	40	24	39	57
Torque constant at 150°C K_t	N-m/Arms	1.17	0.60	1.4	0.86	1.21
	lb-In/Arms	10.35	5.31	12.39	7.61	10.71
Voltage constant K_e (ph-ph)	V/kRPM	68.6	35	86.50	53	76.90
Inductance (per phase)	mH	13.0	3.4	10.5	4.0	5.5
Resistance (per phase)	Ohm	1.45	0.37	0.97	0.33	0.37
Rotor inertia	kg - m ²	4.00E-04	4.00E-04	7.30E-04	7.30E-04	1.06E-03
	in-lbs-sec ²	3.54E-03	3.54E-03	6.46E-03	6.46E-03	9.38E-03
Motor weight	kg	6.4	6.4	9.5	9.5	12.6
	lb	14.11	14.11	20.95	20.95	27.78
Motor poles		8				

* Motor performance does not always reflect system performance. System performance can be found in the following speed-torque curves.



Motor Speed-Torque Performance Curves

PositionServo with MCS Series Motors - 120/240 VAC - 60mm

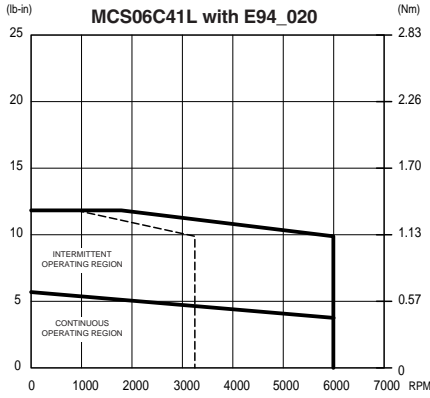

MCS06C41L with E94_020

Motor	Connectors	Intermediate Cables		Drives		
		Power	Feedback	Input Voltage	Drive Models	
MCS06C41LC40	Encoder	EWLB___FE1NA ___ = meter length (002, 005, 010)	EWLE___AE1NA	45...264V** 1Ø 80...264V 1Ø 80...264V 1Ø, 3Ø	E94P020S1NEM* E94P020S2FEM* E94P020Y2NEM*	*To order a drive that meets the ISO13849-1 safety standard replace the "M" in the part number with an "S"
MCS06C41LR50	Resolver	EWLB___FE1NA ___ = meter length (002, 005, 010)	EWLR___BE1NA	45...264V** 1Ø 80...264V 1Ø 80...264V 1Ø, 3Ø	E94R020S1NRM* E94R020S2FRM* E94R020Y2NRM*	

** Voltage Doubler Drive offers 240VAC output when 120VAC input is applied.

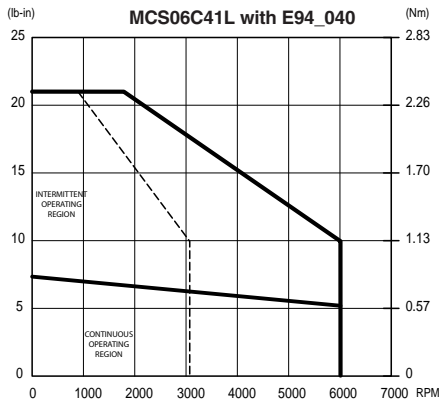

MCS06C41L with E94_040

Motor	Connectors	Intermediate Cables		Drives		
		Power	Feedback	Input Voltage	Drive Models	
MCS06C41LC40	Encoder	EWLB___FE1NA ___ = meter length (002, 005, 010)	EWLE___AE1NA	45...264V** 1Ø 80...264V 1Ø 80...264V 1Ø, 3Ø	E94P040S1NEM* E94P040S2FEM* E94P040Y2NEM*	*To order a drive that meets the ISO13849-1 safety standard replace the "M" in the part number with an "S"
MCS06C41LR50	Resolver	EWLB___FE1NA ___ = meter length (002, 005, 010)	EWLR___BE1NA	45...264V** 1Ø 80...264V 1Ø 80...264V 1Ø, 3Ø	E94R040S1NRM* E94R040S2FRM* E94R040Y2NRM*	

** Voltage Doubler Drive offers 240VAC output when 120VAC input is applied.

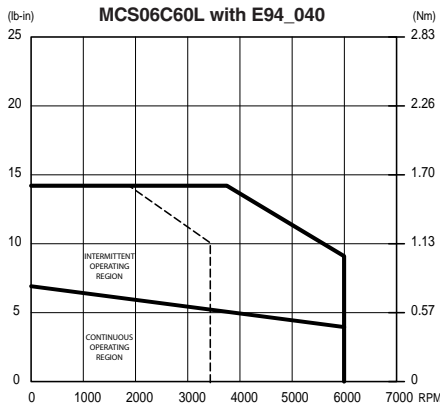

MCS06C60L with E94_040

Motor	Connectors	Intermediate Cables		Drives		
		Power	Feedback	Input Voltage	Drive Models	
MCS06C60LC40	Encoder	EWLB___FE1NA ___ = meter length (002, 005, 010)	EWLE___AE1NA	45...264V** 1Ø 80...264V 1Ø 80...264V 1Ø, 3Ø	E94P040S1NEM* E94P040S2FEM* E94P040Y2NEM*	*To order a drive that meets the ISO13849-1 safety standard replace the "M" in the part number with an "S"
MCS06C60LR50	Resolver	EWLB___FE1NA ___ = meter length (002, 005, 010)	EWLR___BE1NA	45...264V** 1Ø 80...264V 1Ø 80...264V 1Ø, 3Ø	E94R040S1NRM* E94R040S2FRM* E94R040Y2NRM*	

** Voltage Doubler Drive offers 240VAC output when 120VAC input is applied.

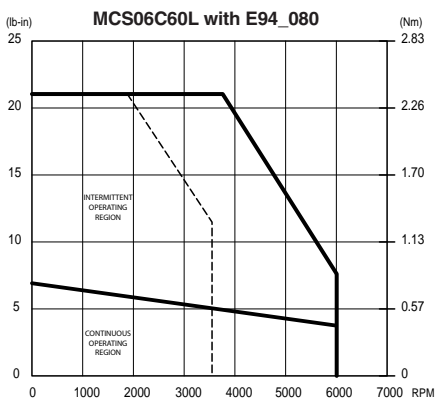

MCS06C60L with E94_080

Motor	Connectors	Intermediate Cables		Drives		
		Power	Feedback	Input Voltage	Drive Models	
MCS06C60LC40	Encoder	EWLB___FE1NA ___ = meter length (002, 005, 010)	EWLE___AE1NA	80...264V 1Ø 80...264V 1Ø, 3Ø	E94P080S2FEM* E94P080Y2NEM*	*To order a drive that meets the ISO13849-1 safety standard replace the "M" in the part number with an "S"
MCS06C60LR50	Resolver	EWLB___FE1NA ___ = meter length (002, 005, 010)	EWLR___BE1NA	80...264V 1Ø 80...264V 1Ø, 3Ø	E94R080S2FRM* E94R080Y2NRM*	

KEY:
 ——— 240 VAC
 - - - - 120 VAC



Motor Speed-Torque Performance Curves

PositionServo with MCS Series Motors - 120/240 VAC - 60mm

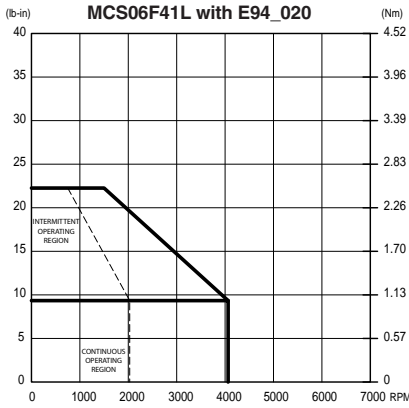

MCS06F41L with E94_020

Motor Models	Connectors Feedback	Intermediate Cables		Drives	
		Power	Feedback	Input Voltage	Drive Models
MCS06F41LC40	Encoder	EWLB_ _FE1NA --- = meter length (002, 005, 010)	EWLE_ _AE1NA	45...264V** 1Ø 80...264V 1Ø, 3Ø	E94P020S1NEM* E94P020S2FEM* E94P020Y2NEX*
MCS06F41LRSO	Resolver	EWLB_ _FE1NA --- = meter length (002, 005, 010)	EWLR_ _BE1NA	45...264V** 1Ø 80...264V 1Ø, 3Ø	E94R020S1NRM* E94R020S2FRM* E94R020Y2NRM*

** Voltage Doubler Drive offers 240VAC output when 120VAC input is applied.

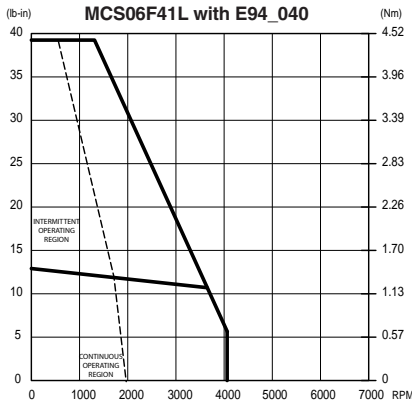

MCS06F41L with E94_040

Motor Models	Connectors Feedback	Intermediate Cables		Drives	
		Power	Feedback	Input Voltage	Drive Models
MCS06F41LC40	Encoder	EWLB_ _FE1NA --- = meter length (002, 005, 010)	EWLE_ _AE1NA	45...264V** 1Ø 80...264V 1Ø, 3Ø	E94P040S1NEM* E94P040S2FEM* E94P040Y2NEM*
MCS06F41LRSO	Resolver	EWLB_ _FE1NA --- = meter length (002, 005, 010)	EWLR_ _BE1NA	45...264V** 1Ø 80...264V 1Ø, 3Ø	E94R040S1NRM* E94R040S2FRM* E94R040Y2NRM*

** Voltage Doubler Drive offers 240VAC output when 120VAC input is applied.

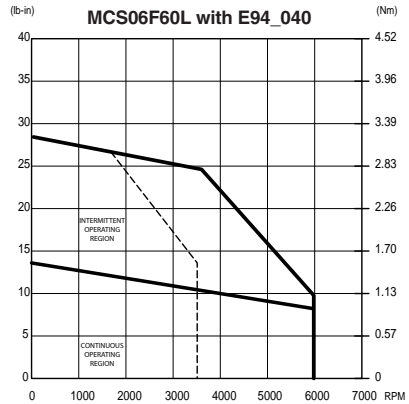

MCS06F60L with E94_040

Motor Models	Connectors Feedback	Intermediate Cables		Drives	
		Power	Feedback	Input Voltage	Drive Models
MCS06F60LC40	Encoder	EWLB_ _FE1NA --- = meter length (002, 005, 010)	EWLE_ _AE1NA	45...264V** 1Ø 80...264V 1Ø, 3Ø	E94P040S1NEM* E94P040S2FEM* E94P040Y2NEM*
MCS06F60LRSO	Resolver	EWLB_ _FE1NA --- = meter length (002, 005, 010)	EWLR_ _BE1NA	45...264V** 1Ø 80...264V 1Ø, 3Ø	E94R040S1NRM* E94R040S2FRM* E94R040Y2NRM*

** Voltage Doubler Drive offers 240VAC output when 120VAC input is applied.

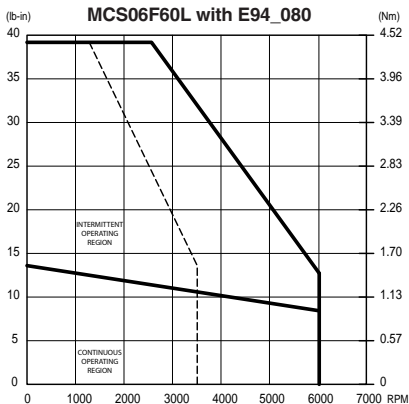

MCS06F60L with E94_080

Motor Models	Connectors Feedback	Intermediate Cables		Drives	
		Power	Feedback	Input Voltage	Drive Models
MCS06F60LC40	Encoder	EWLB_ _FE1NA --- = meter length (002, 005, 010)	EWLE_ _AE1NA	80...264V 1Ø 80...264V 1Ø, 3Ø	E94P080S2FEM* E94P080Y2NEM*
MCS06F60LRSO	Resolver	EWLB_ _FE1NA --- = meter length (002, 005, 010)	EWLR_ _BE1NA	80...264V 1Ø 80...264V 1Ø, 3Ø	E94R080S2FRM* E94R080Y2NRM*

KEY:
 ——— 240 VAC
 - - - - 120 VAC



Motor Speed-Torque Performance Curves

PositionServo with MCS Series Motors - 120/240 VAC - 60mm & 90mm

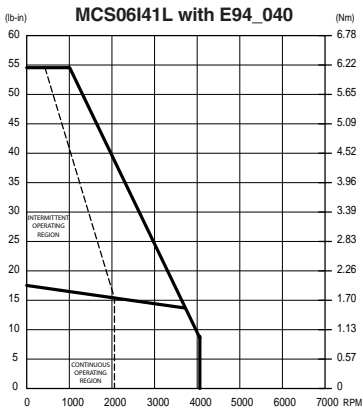

MCS06I41L with E94_040

Motor Models	Connectors Feedback	Intermediate Cables		Drives		
		Power	Feedback	Input Voltage	Drive Models	
MCS06I41LC40	Encoder	EWLB__FE1NA	EWLE__AE1NA	45...264V** 1Ø 80...264V 1Ø	E94P040S1NEM* E94P040S2FEM* E94P040Y2NEM*	*To order a drive that meets the ISO13849-1 safety standard replace the "M" in the part number with an "S"
		___ = meter length (002, 005, 010)		80...264V 1Ø, 3Ø		
MCS06I41LRSO	Resolver	EWLB__FE1NA	EWLR__BE1NA	45...264V** 1Ø 80...264V 1Ø	E94R040S1NRM* E94R040S2FRM* E94R040Y2NRM*	
		___ = meter length (002, 005, 010)		80...264V 1Ø, 3Ø		

** Voltage Doubler Drive offers 240VAC output when 120VAC input is applied.

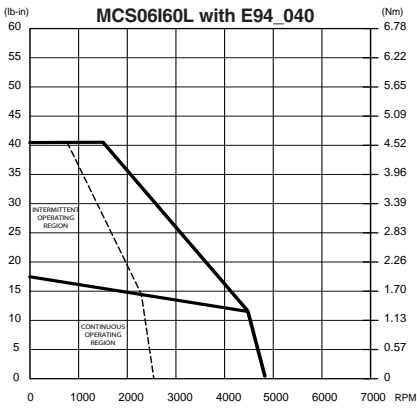

MCS06I60L with E94_040

Motor Models	Connectors Feedback	Intermediate Cables		Drives		
		Power	Feedback	Input Voltage	Drive Models	
MCS06I60LC40	Encoder	EWLB__FE1NA	EWLE__AE1NA	45...264V** 1Ø 80...264V 1Ø	E94P040S1NEM* E94P040S2FEM* E94P040Y2NEM*	*To order a drive that meets the ISO13849-1 safety standard replace the "M" in the part number with an "S"
		___ = meter length (002, 005, 010)		80...264V 1Ø, 3Ø		
MCS06I60LRSO	Resolver	EWLB__FE1NA	EWLR__BE1NA	45...264V** 1Ø 80...264V 1Ø	E94R040S1NRM* E94R040S2FRM* E94R040Y2NRM*	
		___ = meter length (002, 005, 010)		80...264V 1Ø, 3Ø		

** Voltage Doubler Drive offers 240VAC output when 120VAC input is applied.

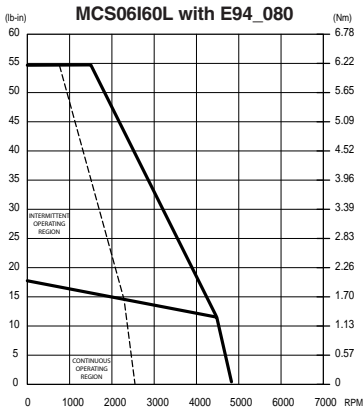

MCS06I60L with E94_080

Motor Models	Connectors Feedback	Intermediate Cables		Drives		
		Power	Feedback	Input Voltage	Drive Models	
MCS06I60LC40	Encoder	EWLB__FE1NA	EWLE__AE1NA	80...264V 1Ø 80...264V 1Ø, 3Ø	E94P080S2FEM* E94P080Y2NEM*	*To order a drive that meets the ISO13849-1 safety standard replace the "M" in the part number with an "S"
		___ = meter length (002, 005, 010)				
MCS06I60LRSO	Resolver	EWLB__FE1NA	EWLR__BE1NA	80...264V 1Ø 80...264V 1Ø, 3Ø	E94R080S2FRM* E94R080Y2NRM*	
		___ = meter length (002, 005, 010)				

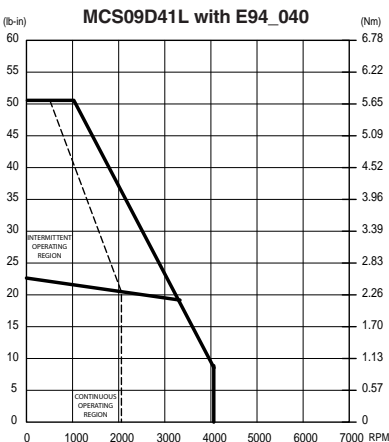

MCS09D41L with E94_040

Motor Models	Connectors Feedback	Intermediate Cables		Drives		
		Power	Feedback	Input Voltage	Drive Models	
MCS09D41LC40	Encoder	EWLB__FE1NA	EWLE__AE1NA	45...264V** 1Ø 80...264V 1Ø	E94P040S1NEM* E94P040S2FEM* E94P040Y2NEM*	*To order a drive that meets the ISO13849-1 safety standard replace the "M" in the part number with an "S"
		___ = meter length (002, 005, 010)		80...264V 1Ø, 3Ø		
MCS09D41LRSO	Resolver	EWLB__FE1NA	EWLR__BE1NA	45...264V** 1Ø 80...264V 1Ø	E94R040S1NRM* E94R040S2FRM* E94R040Y2NRM*	
		___ = meter length (002, 005, 010)		80...264V 1Ø, 3Ø		

** Voltage Doubler Drive offers 240VAC output when 120VAC input is applied.

KEY:
 ——— 240 VAC
 - - - - 120 VAC



Motor Speed-Torque Performance Curves

PositionServo with MCS Series Motors - 120/240 VAC - 90mm

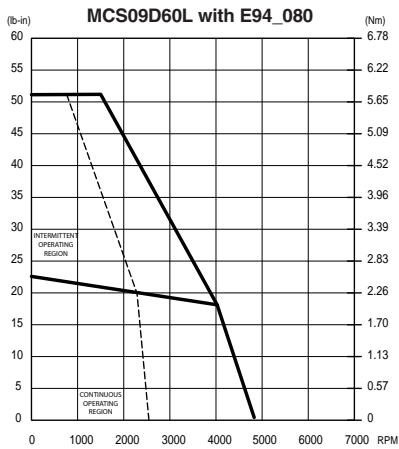

MCS09D60L with E94_080

Motor Models	Connectors Feedback	Intermediate Cables		Drives		
		Power	Feedback	Input Voltage	Drive Models	
MCS09D60LC40	Encoder	EWLB___FE1NA ___ = meter length (002, 005, 010)	EWLE___AE1NA	80...264V 1Ø 80...264V 1Ø, 3Ø	E94P080S2FEM* E94P080Y2NEM*	*To order a drive that meets the ISO13849-1 safety standard replace the "M" in the part number with an "S"
MCS09D60LRSO	Resolver	EWLB___FE1NA ___ = meter length (002, 005, 010)	EWLR___BE1NA	80...264V 1Ø 80...264V 1Ø, 3Ø	E94R080S2FRM* E94R080Y2NRM*	

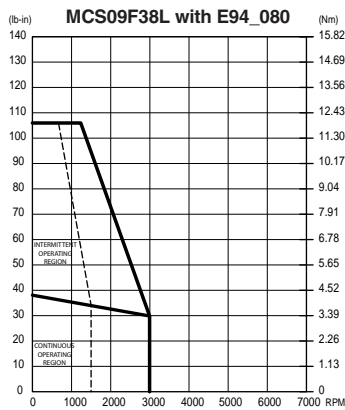

MCS09F38L with E94_080

Motor Models	Connectors Feedback	Intermediate Cables		Drives		
		Power	Feedback	Input Voltage	Drive Models	
MCS09F38LC40	Encoder	EWLB___FE1NA ___ = meter length (002, 005, 010)	EWLE___AE1NA	80...264V 1Ø 80...264V 1Ø, 3Ø	E94P080S2FEM* E94P080Y2NEM*	*To order a drive that meets the ISO13849-1 safety standard replace the "M" in the part number with an "S"
MCS09F38LRSO	Resolver	EWLB___FE1NA ___ = meter length (002, 005, 010)	EWLR___BE1NA	80...264V 1Ø 80...264V 1Ø, 3Ø	E94R080S2FRM* E94R080Y2NRM*	

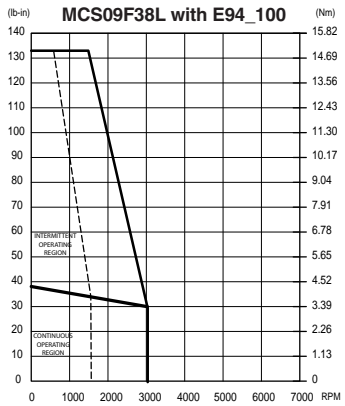

MCS09F38L with E94_100

Motor Models	Connectors Feedback	Intermediate Cables		Drives		
		Power	Feedback	Input Voltage	Drive Models	
MCS09F38LC40	Encoder	EWLB___FE1NA ___ = meter length (002, 005, 010)	EWLE___AE1NA	80...264V 1Ø 80...264V 1Ø, 3Ø	E94P100S2FEM* E94P100Y2NEM*	*To order a drive that meets the ISO13849-1 safety standard replace the "M" in the part number with an "S"
MCS09F38LRSO	Resolver	EWLB___FE1NA ___ = meter length (002, 005, 010)	EWLR___BE1NA	80...264V 1Ø 80...264V 1Ø, 3Ø	E94R100S2FRM* E94R100Y2NRM*	

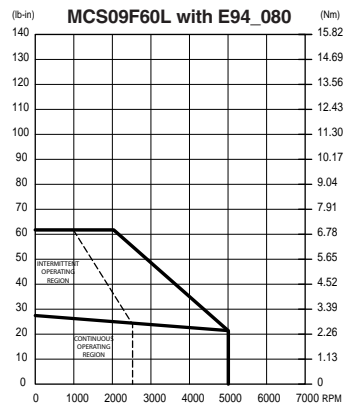

MCS09F60L with E94_080

Motor Models	Connectors Feedback	Intermediate Cables		Drives		
		Power	Feedback	Input Voltage	Drive Models	
MCS09F60LC40	Encoder	EWLB___FE1NA ___ = meter length (002, 005, 010)	EWLE___AE1NA	80...264V 1Ø 80...264V 1Ø, 3Ø	E94P080S2FEM* E94P080Y2NEM*	*To order a drive that meets the ISO13849-1 safety standard replace the "M" in the part number with an "S"
MCS09F60LRSO	Resolver	EWLB___FE1NA ___ = meter length (002, 005, 010)	EWLR___BE1NA	80...264V 1Ø 80...264V 1Ø, 3Ø	E94R080S2FRM* E94R080Y2NRM*	

KEY:
 ——— 240 VAC
 - - - - 120 VAC

Motor Speed-Torque Performance Curves

PositionServo with MCS Series Motors - 120/240 VAC - 90mm

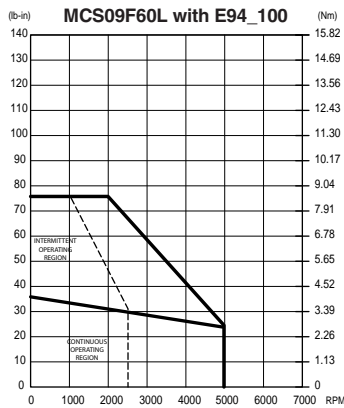

MCS09F60L with E94_100 _____

Motor Models	Connectors Feedback	Intermediate Cables		Drives		
		Power	Feedback	Input Voltage	Drive Models	
MCS09F60LC40	Encoder	EWLB_ _ _FE1NA _ _ _ = meter length (002, 005, 010)	EWLE_ _ _AE1NA	80...264V 1Ø 80...264V 1Ø, 3Ø	E94P100S2FEM* E94P100Y2NEM*	*To order a drive that meets the ISO13849-1 safety standard replace the "M" in the part number with an "S"
MCS09F60LRSO	Resolver	EWLB_ _ _FE1NA _ _ _ = meter length (002, 005, 010)	EWLR_ _ _BE1NA	80...264V 1Ø 80...264V 1Ø, 3Ø	E94R100S2FRM* E94R100Y2NRM*	

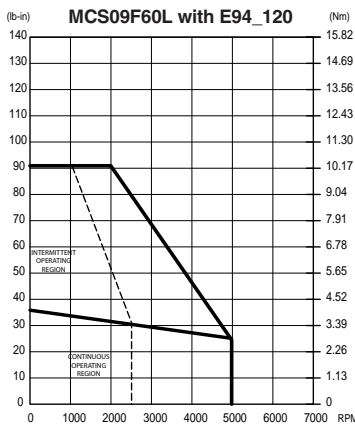

MCS09F60L with E94_120 _____

Motor Models	Connectors Feedback	Intermediate Cables		Drives		
		Power	Feedback	Input Voltage	Drive Models	
MCS09F60LC40	Encoder	EWLB_ _ _FE1NA _ _ _ = meter length (002, 005, 010)	EWLE_ _ _AE1NA	80...264V 1Ø, 3Ø	E94P120Y2NEM*	*To order a drive that meets the ISO13849-1 safety standard replace the "M" in the part number with an "S"
MCS09F60LRSO	Resolver	EWLB_ _ _FE1NA _ _ _ = meter length (002, 005, 010)	EWLR_ _ _BE1NA	80...264V 1Ø, 3Ø	E94R120Y2NRM*	

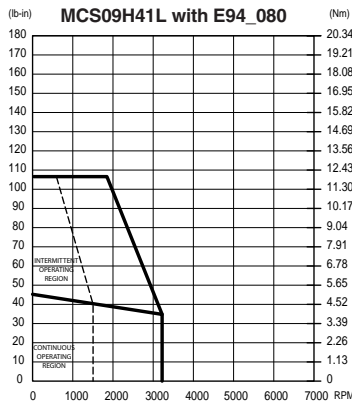

MCS09H41L with E94_080 _____

Motor Models	Connectors Feedback	Intermediate Cables		Drives		
		Power	Feedback	Input Voltage	Drive Models	
MCS09H41LC40	Encoder	EWLB_ _ _FE1NA _ _ _ = meter length (002, 005, 010)	EWLE_ _ _AE1NA	80...264V 1Ø 80...264V 1Ø, 3Ø	E94P080S2FEM* E94P080Y2NEM*	*To order a drive that meets the ISO13849-1 safety standard replace the "M" in the part number with an "S"
MCS09H41LRSO	Resolver	EWLB_ _ _FE1NA _ _ _ = meter length (002, 005, 010)	EWLR_ _ _BE1NA	80...264V 1Ø 80...264V 1Ø, 3Ø	E94R080S2FRM* E94R080Y2NRM*	

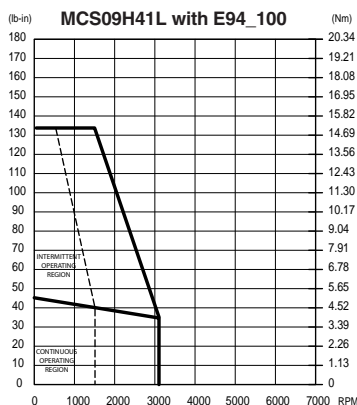

MCS09H41L with E94_100 _____

Motor Models	Connectors Feedback	Intermediate Cables		Drives		
		Power	Feedback	Input Voltage	Drive Models	
MCS09H41LC40	Encoder	EWLB_ _ _FE1NA _ _ _ = meter length (002, 005, 010)	EWLE_ _ _AE1NA	80...264V 1Ø 80...264V 1Ø, 3Ø	E94P100S2FEM* E94P100Y2NEM*	*To order a drive that meets the ISO13849-1 safety standard replace the "M" in the part number with an "S"
MCS09H41LRSO	Resolver	EWLB_ _ _FE1NA _ _ _ = meter length (002, 005, 010)	EWLR_ _ _BE1NA	80...264V 1Ø 80...264V 1Ø, 3Ø	E94R100S2FRM* E94R100Y2NRM*	

KEY:
 ——— 240 VAC
 - - - - 120 VAC

Motor Speed-Torque Performance Curves

PositionServo with MCS Series Motors - 120/240 VAC - 90mm

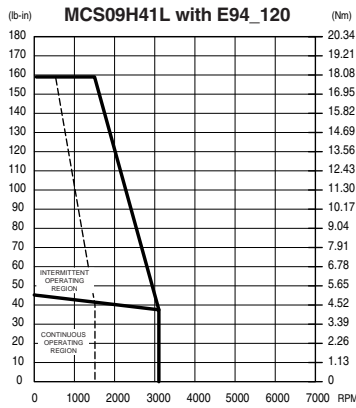

MCS09H41L with E94_120

Motor	Connectors	Intermediate Cables		Drives		
		Power	Feedback	Input Voltage	Drive Models	
MCS09H41LC40	Encoder	EWLB___FE1NA ___ = meter length (002, 005, 010)	EWLE___AE1NA	80...264V 1Ø, 3Ø	E94P120Y2NEM*	*To order a drive that meets the ISO13849-1 safety standard replace the "M" in the part number with an "S"
MCS09H41LR50	Resolver	EWLB___FE1NA ___ = meter length (002, 005, 010)	EWLR___BE1NA	80...264V 1Ø, 3Ø	E94R120Y2NRM*	

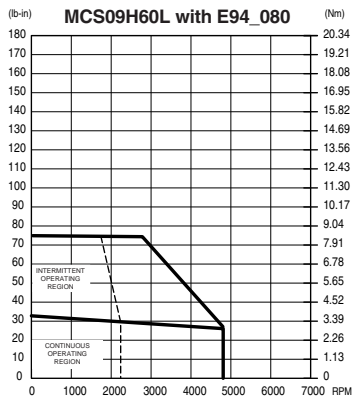

MCS09H60L with E94_080

Motor	Connectors	Intermediate Cables		Drives		
		Power	Feedback	Input Voltage	Drive Models	
MCS09H60LC40	Encoder	EWLB___FE1NA ___ = meter length (002, 005, 010)	EWLE___AE1NA	80...264V 1Ø 80...264V 1Ø, 3Ø	E94P080S2FEM* E94P080Y2NEM*	*To order a drive that meets the ISO13849-1 safety standard replace the "M" in the part number with an "S"
MCS09H60LR50	Resolver	EWLB___FE1NA ___ = meter length (002, 005, 010)	EWLR___BE1NA	80...264V 1Ø 80...264V 1Ø, 3Ø	E94R080S2FRM* E94R080Y2NRM*	

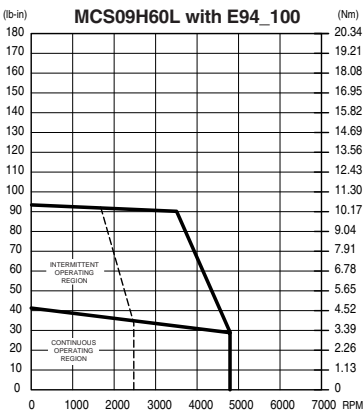

MCS09H60L with E94_100

Motor	Connectors	Intermediate Cables		Drives		
		Power	Feedback	Input Voltage	Drive Models	
MCS09H60LC40	Encoder	EWLB___FE1NA ___ = meter length (002, 005, 010)	EWLE___AE1NA	80...264V 1Ø 80...264V 1Ø, 3Ø	E94P100S2FEM* E94P100Y2NEM*	*To order a drive that meets the ISO13849-1 safety standard replace the "M" in the part number with an "S"
MCS09H60LR50	Resolver	EWLB___FE1NA ___ = meter length (002, 005, 010)	EWLR___BE1NA	80...264V 1Ø 80...264V 1Ø, 3Ø	E94R100S2FRM* E94R100Y2NRM*	

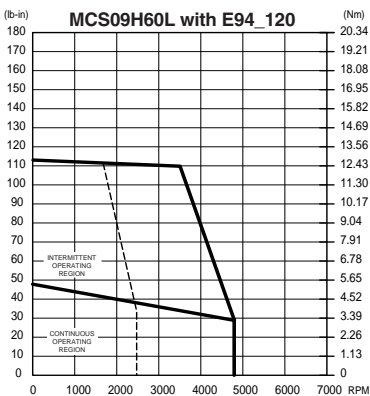

MCS09H60L with E94_120

Motor	Connectors	Intermediate Cables		Drives		
		Power	Feedback	Input Voltage	Drive Models	
MCS09H60LC40	Encoder	EWLB___FE1NA ___ = meter length (002, 005, 010)	EWLE___AE1NA	80...264V 1Ø, 3Ø	E94P120Y2NEM*	*To order a drive that meets the ISO13849-1 safety standard replace the "M" in the part number with an "S"
MCS09H60LR50	Resolver	EWLB___FE1NA ___ = meter length (002, 005, 010)	EWLR___BE1NA	80...264V 1Ø, 3Ø	E94R120Y2NRM*	

KEY:
 ——— 240 VAC
 - - - - 120 VAC

Motor Speed-Torque Performance Curves

PositionServo with MCS Series Motors - 120/240 VAC - 90 and 120mm

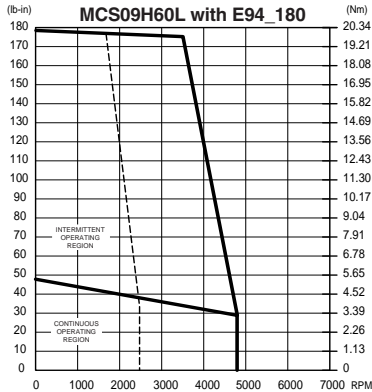

MCS09H60L with E94_180

Motor Models	Connectors Feedback	Intermediate Cables		Drives		
		Power	Feedback	Input Voltage	Drive Models	
MCS09H60LC40	Encoder	EWLB__FE1NA ___ = meter length (002, 005, 010)	EWLE__AE1NA	80...264V 1Ø, 3Ø	E94P180Y2NEM*	*To order a drive that meets the ISO13849-1 safety standard replace the "M" in the part number with an "S"
MCS09H60LRSO	Resolver	EWLB__FE1NA ___ = meter length (002, 005, 010)	EWLR__BE1NA	80...264V 1Ø, 3Ø	E94R180Y2NRM*	

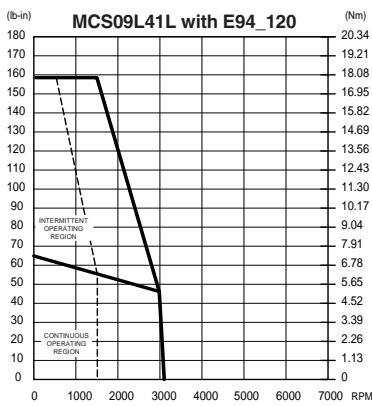

MCS09L41L with E94_120

Motor Models	Connectors Feedback	Intermediate Cables		Drives		
		Power	Feedback	Input Voltage	Drive Models	
MCS09L41LC40	Encoder	EWLB__FE1NA ___ = meter length (002, 005, 010)	EWLE__AE1NA	80...264V 1Ø, 3Ø	E94P120Y2NEM*	*To order a drive that meets the ISO13849-1 safety standard replace the "M" in the part number with an "S"
MCS09L41LRSO	Resolver	EWLB__FE1NA ___ = meter length (002, 005, 010)	EWLR__BE1NA	80...264V 1Ø, 3Ø	E94R120Y2NRM*	

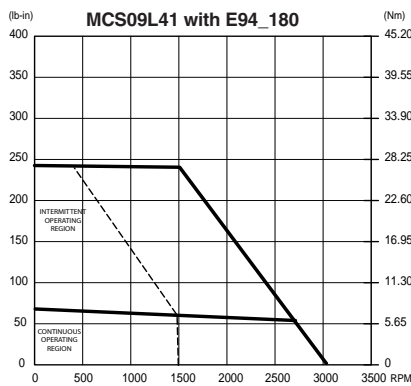

MCS09L41 with E94_180

Motor Models	Connectors Feedback	Intermediate Cables		Drives		
		Power	Feedback	Input Voltage	Drive Models	
MCS09L41LC40	Encoder	EWLB__FE1NA ___ = meter length (002, 005, 010)	EWLE__AE1NA	80...264V 1Ø, 3Ø	E94P180Y2NEM*	*To order a drive that meets the ISO13849-1 safety standard replace the "M" in the part number with an "S"
MCS09L41LRSO	Resolver	EWLB__FE1NA ___ = meter length (002, 005, 010)	EWLR__BE1NA	80...264V 1Ø, 3Ø	E94R180Y2NRM*	

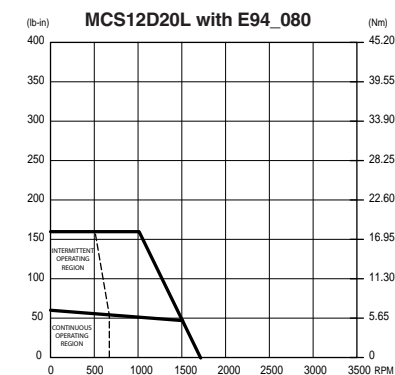

MCS12D20L with E94_080

Motor Models	Connectors Feedback	Intermediate Cables		Drives		
		Power	Feedback	Input Voltage	Drive Models	
MCS12D20LC40	Encoder	EWLB__FE1NA ___ = meter length (002, 005, 010)	EWLE__AE1NA	80...264V 1Ø 80...264V 1Ø, 3Ø	E94P080S2FEM* E94P080Y2NEM*	*To order a drive that meets the ISO13849-1 safety standard replace the "M" in the part number with an "S"
MCS12D20LRSO	Resolver	EWLB__FE1NA ___ = meter length (002, 005, 010)	EWLR__BE1NA	80...264V 1Ø 80...264V 1Ø, 3Ø	E94R080S2FRM* E94R080Y2NRM*	

KEY:
 ——— 240 VAC
 - - - - 120 VAC



Motor Speed-Torque Performance Curves

PositionServo with MCS Series Motors - 120/240 VAC - 120mm

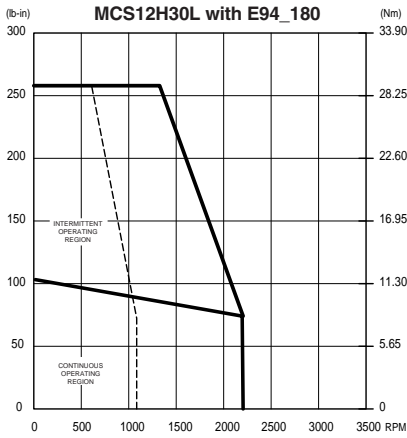

MCS12H30L with E94_180

Motor Models	Connectors Feedback	Intermediate Cables		Drives		
		Power	Feedback	Input Voltage	Drive Models	
MCS12H30LC40	Encoder	EWLB__FE1NA ___ = meter length (002, 005, 010)	EWLE__AE1NA	80...264V 1Ø, 3Ø	E94P180Y2NEM*	*To order a drive that meets the ISO13849-1 safety standard replace the "M" in the part number with an "S"
MCS12H30LRSO	Resolver	EWLB__FE1NA ___ = meter length (002, 005, 010)	EWLR__BE1NA	80...264V 1Ø, 3Ø	E94R180Y2NRM*	

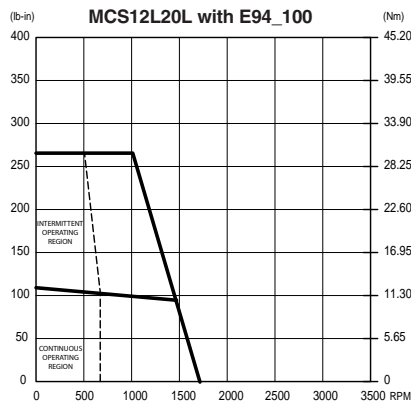

MCS12L20L with E94_100

Motor Models	Connectors Feedback	Intermediate Cables		Drives		
		Power	Feedback	Input Voltage	Drive Models	
MCS12L20LC40	Encoder	EWLB__FE1NA ___ = meter length (002, 005, 010)	EWLE__AE1NA	80...264V 1Ø, 3Ø	E94P100S2FEM* E94P100Y2NEM*	*To order a drive that meets the ISO13849-1 safety standard replace the "M" in the part number with an "S"
MCS12L20LRSO	Resolver	EWLB__FE1NA ___ = meter length (002, 005, 010)	EWLR__BE1NA	80...264V 1Ø, 3Ø	E94R100S2FRM* E94R100Y2NRM*	

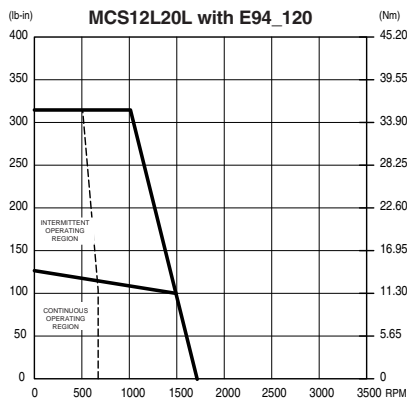

MCS12L20L with E94_120

Motor Models	Connectors Feedback	Intermediate Cables		Drives		
		Power	Feedback	Input Voltage	Drive Models	
MCS12L20LC40	Encoder	EWLB__FE1NA ___ = meter length (002, 005, 010)	EWLE__AE1NA	80...264V 1Ø, 3Ø	E94P120Y2NEM*	*To order a drive that meets the ISO13849-1 safety standard replace the "M" in the part number with an "S"
MCS12L20LRSO	Resolver	EWLB__FE1NA ___ = meter length (002, 005, 010)	EWLR__BE1NA	80...264V 1Ø, 3Ø	E94R120Y2NRM*	

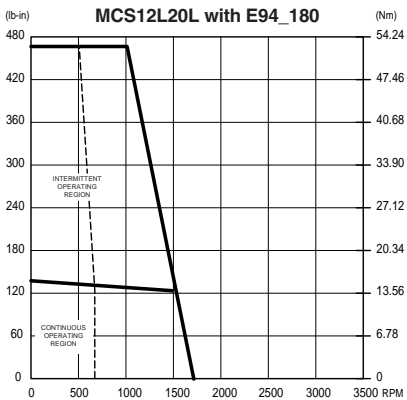

MCS12L20L with E94_180

Motor Models	Connectors Feedback	Intermediate Cables		Drives		
		Power	Feedback	Input Voltage	Drive Models	
MCS12L20LC40	Encoder	EWLB__FE1NA ___ = meter length (002, 005, 010)	EWLE__AE1NA	80...264V 1Ø, 3Ø	E94P180Y2NEM*	*To order a drive that meets the ISO13849-1 safety standard replace the "M" in the part number with an "S"
MCS12L20LRSO	Resolver	EWLB__FE1NA ___ = meter length (002, 005, 010)	EWLR__BE1NA	80...264V 1Ø, 3Ø	E94R180Y2NRM*	

KEY:
 ——— 240 VAC
 - - - - 120 VAC



Parameter*	Units	MCS06C41-	MCS06C60-	MCS06F41-	MCS06F60-	MCS06I41-	MCS06I60-
Maximum mains voltage	VDC	680	680	680	680	680	680
Rated power	kW	0.25	0.31	0.51	0.57	0.64	0.75
Rated speed	RPM	4050	6000	4050	6000	4050	6000
Maximum speed*	RPM	8000	8000	8000	8000	8000	8000
Rated torque	N-m	0.6	0.5	1.2	0.9	1.5	1.2
	lb-In	5.31	4.42	10.62	7.96	13.27	10.62
Continuous stall torque	N-m	0.8	0.8	1.5	1.5	2	2
	lb-In	7.08	7.08	13.27	13.27	17.70	17.70
Peak torque	N-m	2.4	2.4	4.4	4.4	6.2	6.2
	lb-In	21.24	21.24	38.94	38.94	54.87	54.87
Rated current	Arms	1.3	2.4	1.5	2.5	1.6	2.9
Continuous stall current	Arms	1.3	2.5	1.5	2.9	1.7	3.4
Peak current	Arms	5.4	10.8	5.3	10.5	5.9	11.8
Torque constant at 150°C K_t	N-m/Arms	0.66	0.33	1.05	0.53	1.21	0.6
	lb-In/Arms	5.84	2.92	9.29	4.69	10.71	5.31
Voltage constant K_e (ph-ph)	V/kRPM	36.6	18.3	60.1	30	73.4	36.7
Rotor inertia	kg - m ²	1.40E-5	1.40E-5	2.20E-5	2.20E-5	3.00E-5	3.00E-5
	lbs-In-sec ²	1.24E-4	1.24E-4	1.95E-4	1.95E-4	2.66E-4	2.66E-4
Motor weight	kg	1.8	1.8	2.2	2.2	2.9	2.9
	lb	3.97	3.97	4.85	4.85	6.39	6.39

Parameter*	Units	MCS09D41-	MCS09D60-	MCS09F38-	MCS09F60-	MCS09H41-	MCS09H60-	MCS09L41-
Maximum bus power	VDC	680	680	680	680	680	680	680
Rated power	kW	1	1.1	1.2	1.5	1.6	1.9	1.9
Rated speed	RPM	4050	6000	3750	6000	4050	6000	4050
Maximum speed*	RPM	7000	7000	7000	7000	7000	7000	7000
Rated torque	N-m	2.3	1.8	3.1	2.4	3.8	3	4.5
	lb-In	20.35	15.93	27.43	21.24	33.63	26.55	39.82
Continuous stall torque	N-m	3.3	3.3	4.2	4.2	5.5	5.5	7.5
	lb-In	29.20	29.20	37.17	37.17	48.67	48.67	66.37
Peak torque	N-m	9.5	9.5	15	15	20	20	32
	lb-In	84.07	84.07	132.74	132.74	176.99	176.99	283.19
Rated current	Arms	2.3	3.8	2.5	4.5	3.4	6	4.2
Continuous stall current	Arms	2.60	5.30	3	6	4.3	8.5	6.20
Peak current	Arms	10	20	15	30	20	40	32
Torque constant at 150°C K_t	N-m/Arms	1.25	0.62	1.4	0.7	1.29	0.65	1.21
	lb-In/Arms	11.06	5.49	12.39	6.19	11.42	5.75	10.71
Voltage constant K_e (ph-ph)	V/kRPM	71.20	35.60	79.8	39.9	75.7	37.8	71.70
Rotor inertia	kg - m ²	1.10E-4	1.10E-4	1.50E-4	1.50E-4	1.90E-4	1.90E-4	2.80E-4
	lbs-In-sec ²	9.74E-4	9.74E-4	1.33E-3	1.33E-3	1.68E-3	1.68E-3	2.48E-3
Motor weight	kg	4.30	4.30	5.2	5.2	6.1	6.1	7.90
	lb	9.48	9.48	11.47	11.47	13.45	13.45	17.42

* Motor performance does not always reflect system performance. System performance can be found in the following speed-torque curves.

Parameter*	Units	MCS12D20-	MCS12D41-	MCS12H15-	MCS12H35-	MCS12L20-	MCS12L41-
Maximum mains voltage	VDC	680	680	680	680	680	680
Rated power	kW	1.1	1.8	1.6	2.8	2.8	4.7
Rated speed	RPM	1950	4050	1500	3525	1950	4050
Maximum speed*	RPM	6000	6000	6000	6000	6000	6000
Rated torque	N-m	5.5	4.3	10	7.5	13.5	11
	lb-In	48.67	38.05	88.50	66.37	119.47	97.35
Continuous stall torque	N-m	6.4	6.4	11.4	11.4	15	15
	lb-In	56.64	56.64	100.88	100.88	132.74	132.74
Peak torque	N-m	18	18	29	29	56	56
	lb-In	159.29	159.29	256.64	256.64	495.58	495.58
Rated current	Arms	2.6	4.5	3.8	5.7	5.9	10.2
Continuous stall current	Arms	2.7	5.5	4.1	8.2	6.2	12.4
Peak current	Arms	10	20	12	24	28	57
Torque constant at 150°C K_t	N-m/Arms	2.34	1.17	2.79	1.4	2.42	1.21
	lb-In/Arms	20.71	10.35	24.69	12.39	21.42	10.71
Voltage constant K_s (ph-ph)	V/kRPM	137.3	68.6	172.9	86.5	149.2	74.6
Rotor inertia	kg - m ²	4.00E-4	4.00E-4	7.30E-4	7.30E-4	1.06E-3	1.06E-3
	lbs-In-sec ²	3.54E-3	3.54E-3	6.46E-3	6.46E-3	9.38E-3	9.38E-3
Motor weight	kg	6.4	6.4	9.5	9.5	12.6	12.6
	lb	14.11	14.11	20.95	20.95	27.78	27.78

Parameter*	Units	MCS14D15-	MCS14D36-	MCS14H15-	MCS19F14-
Maximum bus power	VDC	680	680	680	680
Rated power	kW	1.45	2.8	2.5	4
Rated speed	RPM	1500	3600	1500	1425
Maximum speed*	RPM	6000	6000	6000	4000
Rated torque	N-m	9.2	7.5	16	27
	lb-In	81.42	66.37	141.59	238.94
Continuous stall torque	N-m	11	11	21	32
	lb-In	97.35	97.35	185.84	283.19
Peak torque	N-m	29	29	55	86
	lb-In	256.64	256.64	486.73	761.06
Rated current	Arms	4.5	7.5	6.6	8.6
Continuous stall current	Arms	5	10	8.5	9.9
Peak current	Arms	17	33	26	31
Torque constant at 150°C K_t	N-m/Arms	2.19	1.09	2.48	3.23
	lb-In/Arms	19.38	9.65	21.95	28.58
Voltage constant K_s (ph-ph)	V/kRPM	128.5	64.2	152.6	194.5
Rotor inertia	kg - m ²	8.10E-4	8.10E-4	1.42E-3	6.50E-3
	lbs-In-sec ²	7.17E-3	7.17E-3	1.26E-2	5.75E-2
Motor weight	kg	10.7	10.7	15.5	23
	lb	23.59	23.59	34.18	50.72

* Motor performance does not always reflect system performance. System performance can be found in the following speed-torque curves.



Motor Speed-Torque Performance Curves

PositionServo with MCS Series Motors - 400/480 VAC - 60mm

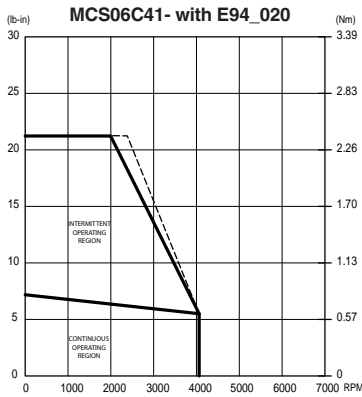

MCS06C41- with E94_020T4N _ _

Motor Models	Connectors Feedback	Intermediate Cables		Drives		
		Power	Feedback	Input Voltage	Drive Models	
MCS06C41-C40	Encoder	EWLB__FE1NA ___ = meter length (002, 005, 010)	EWLE__AE1NA	400...480V 3Ø	E94P020T4NEM*	*To order a drive that meets the ISO13849-1 safety standard replace the "M" in the part number with an "S"
MCS06C41-RSO	Resolver	EWLB__FE1NA ___ = meter length (002, 005, 010)	EWLR__BE1NA	400...480V 3Ø	E94R020T4NRM*	

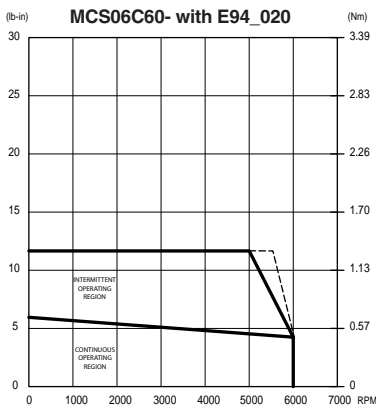

MCS06C60- with E94_020T4N _ _

Motor Models	Connectors Feedback	Intermediate Cables		Input Voltage	Drive Models	
		Power	Feedback			
MCS06C60-C40	Encoder	EWLB__FE1NA ___ = meter length (002, 005, 010)	EWLE__AE1NA	400...480V 3Ø	E94P020T4NEM*	*To order a drive that meets the ISO13849-1 safety standard replace the "M" in the part number with an "S"
MCS06C60-RSO	Resolver	EWLB__FE1NA ___ = meter length (002, 005, 010)	EWLR__BE1NA	400...480V 3Ø	E94R020T4NRM*	

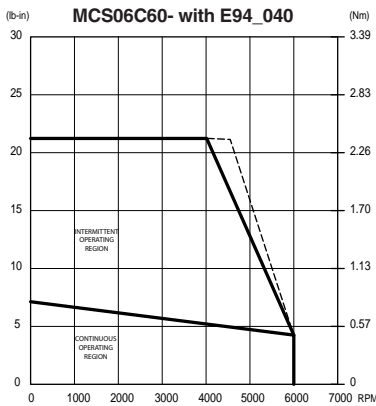

MCS06C60- with E94_040T4N _ _

Motor Models	Connectors Feedback	Intermediate Cables		Input Voltage	Drive Models	
		Power	Feedback			
MCS06C60-C40	Encoder	EWLB__FE1NA ___ = meter length (002, 005, 010)	EWLE__AE1NA	400...480V 3Ø	E94P040T4NEM*	*To order a drive that meets the ISO13849-1 safety standard replace the "M" in the part number with an "S"
MCS06C60-RSO	Resolver	EWLB__FE1NA ___ = meter length (002, 005, 010)	EWLR__BE1NA	400...480V 3Ø	E94R040T4NRM*	

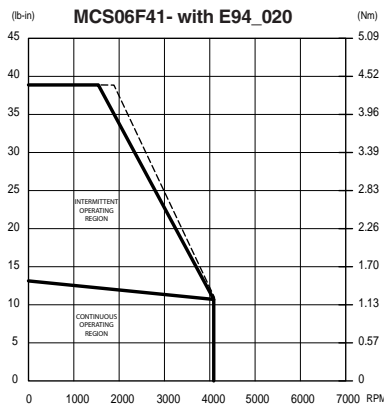

MCS06F41- with E94_020T4N _ _

Motor Models	Connectors Feedback	Intermediate Cables		Input Voltage	Drive Models	
		Power	Feedback			
MCS06F41-C40	Encoder	EWLB__FE1NA ___ = meter length (002, 005, 010)	EWLE__AE1NA	400...480V 3Ø	E94P020T4NEM*	*To order a drive that meets the ISO13849-1 safety standard replace the "M" in the part number with an "S"
MCS06F41-RSO	Resolver	EWLB__FE1NA ___ = meter length (002, 005, 010)	EWLR__BE1NA	400...480V 3Ø	E94R020T4NRM*	

KEY:
 ——— 400 VAC
 - - - - 480 VAC



Motor Speed-Torque Performance Curves

PositionServo with MCS Series Motors - 400/480 VAC - 60mm

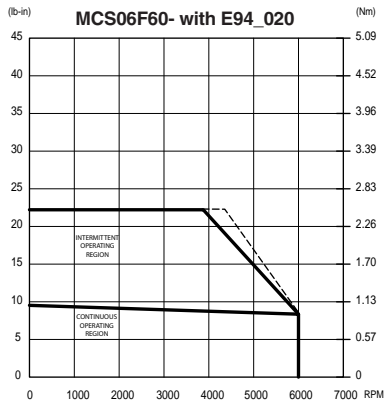

MCS06F60- with E94_020T4N __

Motor Models	Connectors Feedback	Intermediate Cables		Drives		
		Power	Feedback	Input Voltage	Drive Models	
MCS06F60-C40	Encoder	EWLB__FE1NA ___ = meter length (002, 005, 010)	EWLE__AE1NA	400...480V 3Ø	E94P020T4NEM*	*To order a drive that meets the ISO13849-1 safety standard replace the "M" in the part number with an "S"
MCS06F60-RSO	Resolver	EWLB__FE1NA ___ = meter length (002, 005, 010)	EWLR__BE1NA	400...480V 3Ø	E94R020T4NRM*	

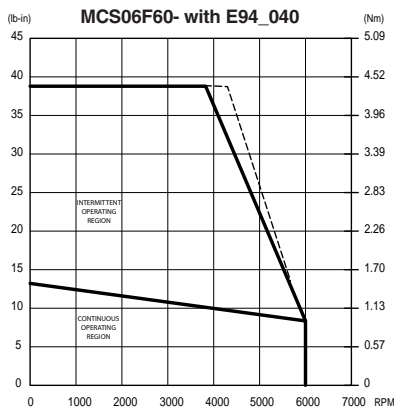

MCS06F60- with E94_040T4N __

Motor Models	Connectors Feedback	Intermediate Cables		Drives		
		Power	Feedback	Input Voltage	Drive Models	
MCS06F60-C40	Encoder	EWLB__FE1NA ___ = meter length (002, 005, 010)	EWLE__AE1NA	400...480V 3Ø	E94P040T4NEM*	*To order a drive that meets the ISO13849-1 safety standard replace the "M" in the part number with an "S"
MCS06F60-RSO	Resolver	EWLB__FE1NA ___ = meter length (002, 005, 010)	EWLR__BE1NA	400...480V 3Ø	E94R040T4NRM*	

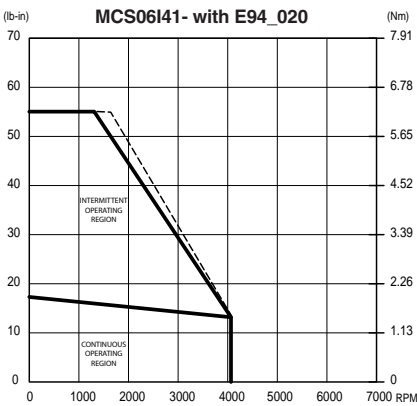

MCS06I41- with E94_020T4N __

Motor Models	Connectors Feedback	Intermediate Cables		Drives		
		Power	Feedback	Input Voltage	Drive Models	
MCS06I41-C40	Encoder	EWLB__FE1NA ___ = meter length (002, 005, 010)	EWLE__AE1NA	400...480V 3Ø	E94P020T4NEM*	*To order a drive that meets the ISO13849-1 safety standard replace the "M" in the part number with an "S"
MCS06I41-RSO	Resolver	EWLB__FE1NA ___ = meter length (002, 005, 010)	EWLR__BE1NA	400...480V 3Ø	E94R020T4NRM*	

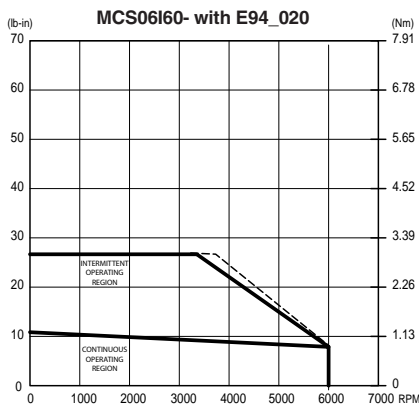

MCS06I60- with E94_020T4N __

Motor Models	Connectors Feedback	Intermediate Cables		Drives		
		Power	Feedback	Input Voltage	Drive Models	
MCS06I60-C40	Encoder	EWLB__FE1NA ___ = meter length (002, 005, 010)	EWLE__AE1NA	400...480V 3Ø	E94P020T4NEM*	*To order a drive that meets the ISO13849-1 safety standard replace the "M" in the part number with an "S"
MCS06I60-RSO	Resolver	EWLB__FE1NA ___ = meter length (002, 005, 010)	EWLR__BE1NA	400...480V 3Ø	E94R020T4NRM*	

KEY:
 ——— 400 VAC
 - - - 480 VAC



Motor Speed-Torque Performance Curves

PositionServo with MCS Series Motors - 400/480 VAC - 60 and 90mm

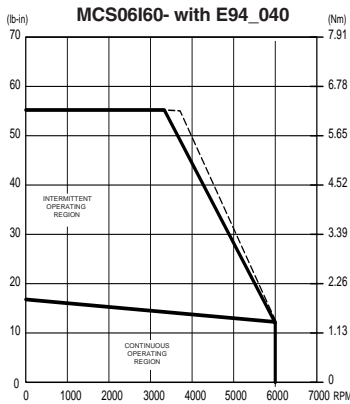

MCS06I60- with E94_040T4N_ _

Motor	Connectors	Intermediate Cables		Drives		
		Power	Feedback	Input Voltage	Drive Models	
MCS06I60-C40	Encoder	EWLB_ _ _FE1NA _ _ _ = meter length (002, 005, 010)	EWLE_ _ _AE1NA	400...480V 3Ø	E94P040T4NEM*	*To order a drive that meets the ISO13849-1 safety standard replace the "M" in the part number with an "S"
MCS06I60-RSO	Resolver	EWLB_ _ _FE1NA _ _ _ = meter length (002, 005, 010)	EWLR_ _ _BE1NA	400...480V 3Ø	E94R040T4NRM*	

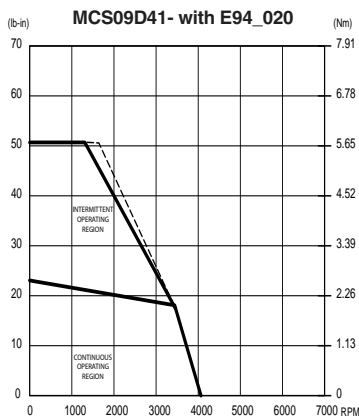

MCS09D41- with E94_020T4N_ _

Motor	Connectors	Intermediate Cables		Drives		
		Power	Feedback	Input Voltage	Drive Models	
MCS09D41-C40	Encoder	EWLB_ _ _FE1NA _ _ _ = meter length (002, 005, 010)	EWLE_ _ _AE1NA	400...480V 3Ø	E94P020T4NEM*	*To order a drive that meets the ISO13849-1 safety standard replace the "M" in the part number with an "S"
MCS09D41-RSO	Resolver	EWLB_ _ _FE1NA _ _ _ = meter length (002, 005, 010)	EWLR_ _ _BE1NA	400...480V 3Ø	E94R020T4NRM*	

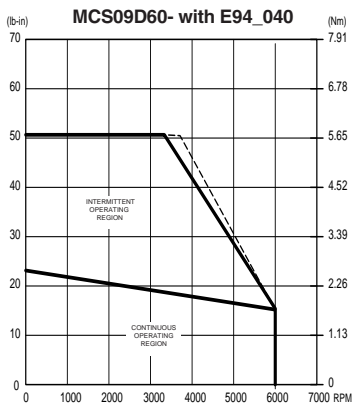

MCS09D60- with E94_040T4N_ _

Motor	Connectors	Intermediate Cables		Drives		
		Power	Feedback	Input Voltage	Drive Models	
MCS09D60-C40	Encoder	EWLB_ _ _FE1NA _ _ _ = meter length (002, 005, 010)	EWLE_ _ _AE1NA	400...480V 3Ø	E94P040T4NEM*	*To order a drive that meets the ISO13849-1 safety standard replace the "M" in the part number with an "S"
MCS09D60-RSO	Resolver	EWLB_ _ _FE1NA _ _ _ = meter length (002, 005, 010)	EWLR_ _ _BE1NA	400...480V 3Ø	E94R040T4NRM*	

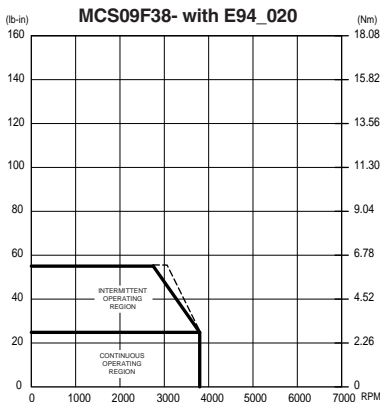

MCS09F38- with E94_020T4N_ _

Motor	Connectors	Intermediate Cables		Drives		
		Power	Feedback	Input Voltage	Drive Models	
MCS09F38-C40	Encoder	EWLB_ _ _FE1NA _ _ _ = meter length (002, 005, 010)	EWLE_ _ _AE1NA	400...480V 3Ø	E94P020T4NEM*	*To order a drive that meets the ISO13849-1 safety standard replace the "M" in the part number with an "S"
MCS09F38-RSO	Resolver	EWLB_ _ _FE1NA _ _ _ = meter length (002, 005, 010)	EWLR_ _ _BE1NA	400...480V 3Ø	E94R020T4NRM*	

KEY:
 ——— 400 VAC
 - - - 480 VAC



Motor Speed-Torque Performance Curves

PositionServo with MCS Series Motors - 400/480 VAC - 90mm

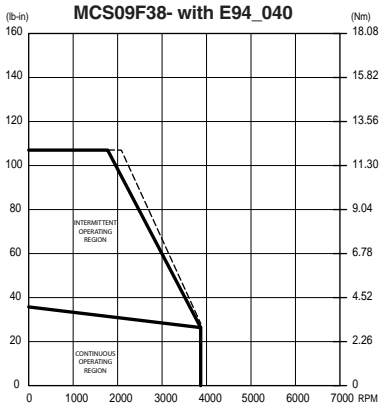

MCS09F38- with E94_040T4N__

Motor Models	Connectors Feedback	Intermediate Cables		Drives		
		Power	Feedback	Input Voltage	Drive Models	
MCS09F38-C40	Encoder	EWLB__FE1NA ___ = meter length (002, 005, 010)	EWLE__AE1NA	400...480V 3Ø	E94P040T4NEM*	*To order a drive that meets the ISO13849-1 safety standard replace the "M" in the part number with an "S"
MCS09F38-RSO	Resolver	EWLB__FE1NA ___ = meter length (002, 005, 010)	EWLR__BE1NA	400...480V 3Ø	E94R040T4NRM*	

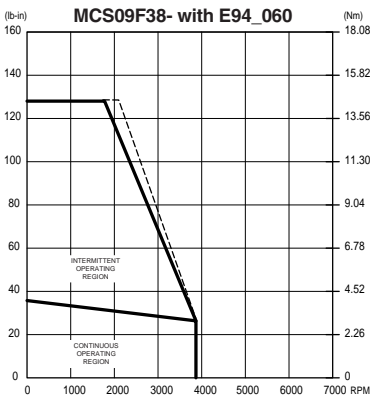

MCS09F38- with E94_060T4N__

Motor Models	Connectors Feedback	Intermediate Cables		Drives		
		Power	Feedback	Input Voltage	Drive Models	
MCS09F38-C40	Encoder	EWLB__FE1NA ___ = meter length (002, 005, 010)	EWLE__AE1NA	400...480V 3Ø	E94P060T4NEM*	*To order a drive that meets the ISO13849-1 safety standard replace the "M" in the part number with an "S"
MCS09F38-RSO	Resolver	EWLB__FE1NA ___ = meter length (002, 005, 010)	EWLR__BE1NA	400...480V 3Ø	E94R060T4NRM*	

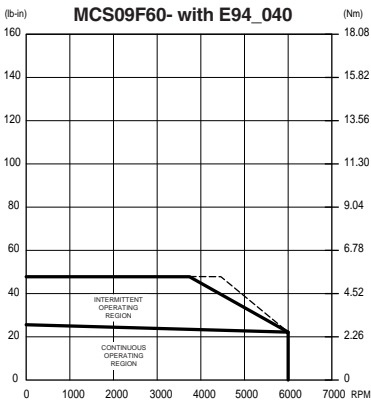

MCS09F60- with E94_040T4N__

Motor Models	Connectors Feedback	Intermediate Cables		Drives		
		Power	Feedback	Input Voltage	Drive Models	
MCS09F60-C40	Encoder	EWLB__FE1NA ___ = meter length (002, 005, 010)	EWLE__AE1NA	400...480V 3Ø	E94P040T4NEM*	*To order a drive that meets the ISO13849-1 safety standard replace the "M" in the part number with an "S"
MCS09F60-RSO	Resolver	EWLB__FE1NA ___ = meter length (002, 005, 010)	EWLR__BE1NA	400...480V 3Ø	E94R040T4NRM*	

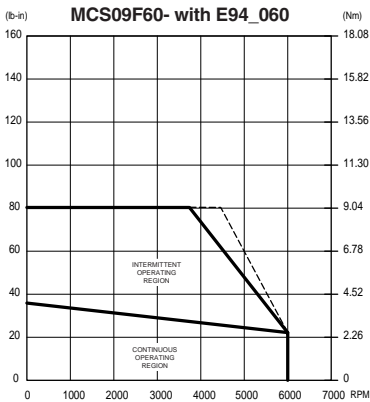

MCS09F60- with E94_060T4N__

Motor Models	Connectors Feedback	Intermediate Cables		Drives		
		Power	Feedback	Input Voltage	Drive Models	
MCS09F60-C40	Encoder	EWLB__FE1NA ___ = meter length (002, 005, 010)	EWLE__AE1NA	400...480V 3Ø	E94P060T4NEM*	*To order a drive that meets the ISO13849-1 safety standard replace the "M" in the part number with an "S"
MCS09F60-RSO	Resolver	EWLB__FE1NA ___ = meter length (002, 005, 010)	EWLR__BE1NA	400...480V 3Ø	E94R060T4NRM*	

KEY:
 ——— 400 VAC
 - - - 480 VAC

Motor Speed - Torque Performance Curves

PositionServo with MCS Series Motors - 400/480 VAC - 90mm

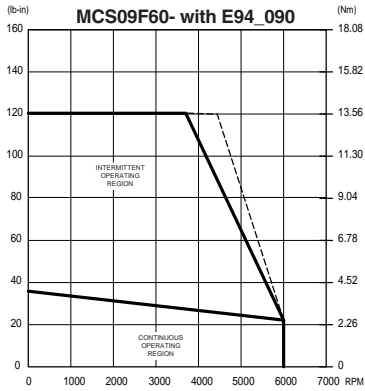

MCS09F60- with E94_090T4N__

Motor Models	Connectors Feedback	Intermediate Cables		Drives		
		Power	Feedback	Input Voltage	Drive Models	
MCS09F60-C40	Encoder	EWLB__FE1NA ___ = meter length (002, 005, 010)	EWLE__AE1NA	400...480V 3Ø	E94P090T4NEM*	*To order a drive that meets the ISO13849-1 safety standard replace the "M" in the part number with an "S"
MCS09F60-RSO	Resolver	EWLB__FE1NA ___ = meter length (002, 005, 010)	EWLR__BE1NA	400...480V 3Ø	E94R090T4NRM*	

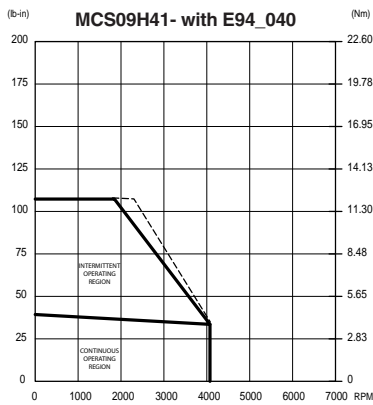

MCS09H41- with E94_040T4N__

Motor Models	Connectors Feedback	Intermediate Cables		Drives		
		Power	Feedback	Input Voltage	Drive Models	
MCS09H41-C40	Encoder	EWLB__FE1NA ___ = meter length (002, 005, 010)	EWLE__AE1NA	400...480V 3Ø	E94P040T4NEM*	*To order a drive that meets the ISO13849-1 safety standard replace the "M" in the part number with an "S"
MCS09H41-RSO	Resolver	EWLB__FE1NA ___ = meter length (002, 005, 010)	EWLR__BE1NA	400...480V 3Ø	E94R040T4NRM*	

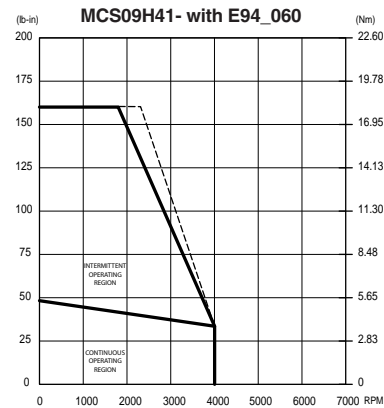

MCS09H41- with E94_060T4N__

Motor Models	Connectors Feedback	Intermediate Cables		Drives		
		Power	Feedback	Input Voltage	Drive Models	
MCS09H41-C40	Encoder	EWLB__FE1NA ___ = meter length (002, 005, 010)	EWLE__AE1NA	400...480V 3Ø	E94P060T4NEM*	*To order a drive that meets the ISO13849-1 safety standard replace the "M" in the part number with an "S"
MCS09H41-RSO	Resolver	EWLB__FE1NA ___ = meter length (002, 005, 010)	EWLR__BE1NA	400...480V 3Ø	E94R060T4NRM*	

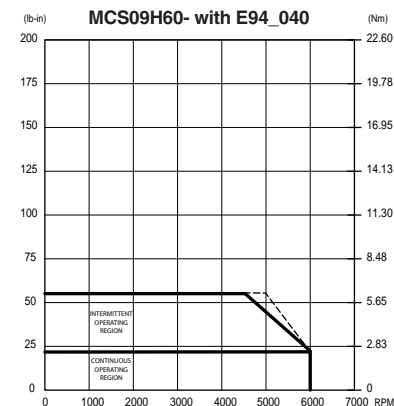

MCS09H60- with E94_040T4N__

Motor Models	Connectors Feedback	Intermediate Cables		Drives		
		Power	Feedback	Input Voltage	Drive Models	
MCS09H60-C40	Encoder	EWLB__FE1NA ___ = meter length (002, 005, 010)	EWLE__AE1NA	400...480V 3Ø	E94P040T4NEM*	*To order a drive that meets the ISO13849-1 safety standard replace the "M" in the part number with an "S"
MCS09H60-RSO	Resolver	EWLB__FE1NA ___ = meter length (002, 005, 010)	EWLR__BE1NA	400...480V 3Ø	E94R040T4NRM*	

KEY:
 ——— 400 VAC
 - - - 480 VAC

Motor Speed - Torque Performance Curves

PositionServo with MCS Series Motors - 400/480 VAC - 90mm

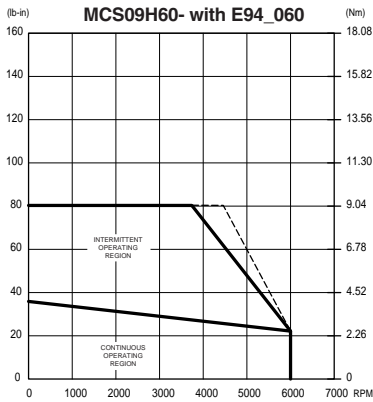

MCS09H60- with E94_060T4N_ _

Motor Models	Connectors Feedback	Intermediate Cables		Drives	
		Power	Feedback	Input Voltage	Drive Models
MCS09H60-C40	Encoder	EWLB_ _ _FE1NA _ _ _ = meter length (002, 005, 010)	EWLE_ _ _AE1NA	400...480V 3Ø	E94P060T4NEM*
MCS09H60-RSO	Resolver	EWLB_ _ _FE1NA _ _ _ = meter length (002, 005, 010)	EWLR_ _ _BE1NA	400...480V 3Ø	E94R060T4NRM*

*To order a drive that meets the ISO13849-1 safety standard replace the "M" in the part number with an "S"

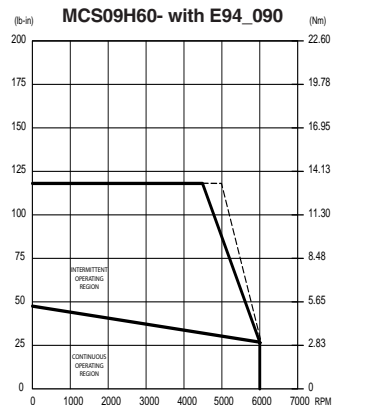

MCS09H60- with E94_090T4N_ _

Motor Models	Connectors Feedback	Intermediate Cables		Drives	
		Power	Feedback	Input Voltage	Drive Models
MCS09H60-C40	Encoder	EWLB_ _ _FE1NA _ _ _ = meter length (002, 005, 010)	EWLE_ _ _AE1NA	400...480V 3Ø	E94P090T4NEM*
MCS09H60-RSO	Resolver	EWLB_ _ _FE1NA _ _ _ = meter length (002, 005, 010)	EWLR_ _ _BE1NA	400...480V 3Ø	E94R090T4NRM*

*To order a drive that meets the ISO13849-1 safety standard replace the "M" in the part number with an "S"

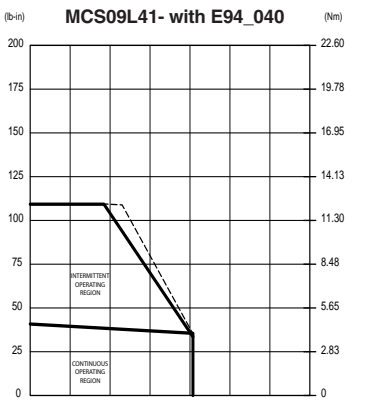

MCS09L41- with E94_040T4N_ _

Motor Models	Connectors Feedback	Intermediate Cables		Drives	
		Power	Feedback	Input Voltage	Drive Models
MCS09L41-C40	Encoder	EWLB_ _ _FE1NA _ _ _ = meter length (002, 005, 010)	EWLE_ _ _AE1NA	400...480V 3Ø	E94P040T4NEM*
MCS09L41-RSO	Resolver	EWLB_ _ _FE1NA _ _ _ = meter length (002, 005, 010)	EWLR_ _ _BE1NA	400...480V 3Ø	E94R040T4NRM*

*To order a drive that meets the ISO13849-1 safety standard replace the "M" in the part number with an "S"

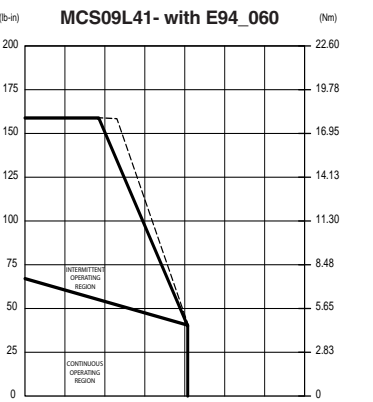

MCS09L41- with E94_060T4N_ _

Motor Models	Connectors Feedback	Intermediate Cables		Drives	
		Power	Feedback	Input Voltage	Drive Models
MCS09L41-C40	Encoder	EWLB_ _ _FE1NA _ _ _ = meter length (002, 005, 010)	EWLE_ _ _AE1NA	400...480V 3Ø	E94P060T4NEM*
MCS09L41-RSO	Resolver	EWLB_ _ _FE1NA _ _ _ = meter length (002, 005, 010)	EWLR_ _ _BE1NA	400...480V 3Ø	E94R060T4NRM*

*To order a drive that meets the ISO13849-1 safety standard replace the "M" in the part number with an "S"

KEY:
 ——— 400 VAC
 - - - 480 VAC



Motor Speed - Torque Performance Curves

PositionServo with MCS Series Motors - 400/480 VAC - 120mm

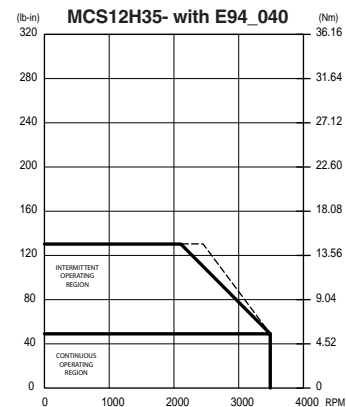
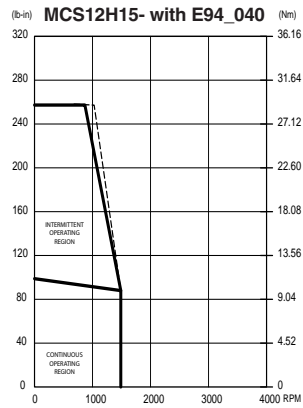
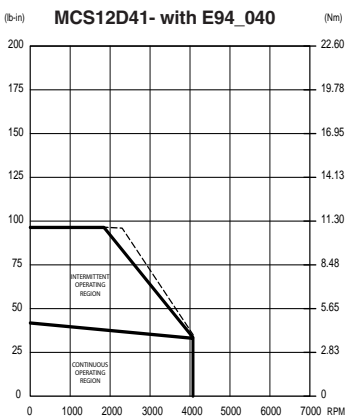
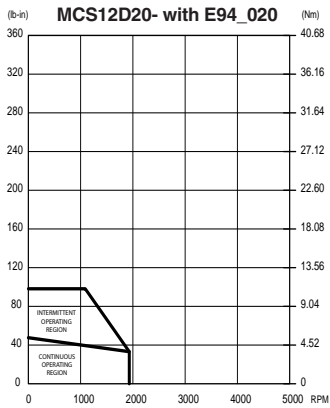

KEY:
 — 400 VAC
 - - - 480 VAC

MCS12D20- with E94_020T4N_ _

Motor Models	Connectors Feedback	Intermediate Cables		Drives		
		Power	Feedback	Input Voltage	Drive Models	
MCS12D20-C40	Encoder	EWLB_ _ _FE1NA _ _ _ = meter length (002, 005, 010)	EWLE_ _ _AE1NA	400...480V 3Ø	E94P020T4NEM*	*To order a drive that meets the ISO13849-1 safety standard replace the "M" in the part number with an "S"
MCS12D20-RSO	Resolver	EWLB_ _ _FE1NA _ _ _ = meter length (002, 005, 010)	EWLR_ _ _BE1NA	400...480V 3Ø	E94R020T4NRM*	

MCS12D41- with E94_040T4N_ _

Motor Models	Connectors Feedback	Intermediate Cables		Drives		
		Power	Feedback	Input Voltage	Drive Models	
MCS12D41-C40	Encoder	EWLB_ _ _FE1NA _ _ _ = meter length (002, 005, 010)	EWLE_ _ _AE1NA	400...480V 3Ø	E94P040T4NEM*	*To order a drive that meets the ISO13849-1 safety standard replace the "M" in the part number with an "S"
MCS12D41-RSO	Resolver	EWLB_ _ _FE1NA _ _ _ = meter length (002, 005, 010)	EWLR_ _ _BE1NA	400...480V 3Ø	E94R040T4NRM*	

MCS12H15- with E94_040T4N_ _

Motor Models	Connectors Feedback	Intermediate Cables		Drives		
		Power	Feedback	Input Voltage	Drive Models	
MCS12H15-C40	Encoder	EWLB_ _ _FE1NA _ _ _ = meter length (002, 005, 010)	EWLE_ _ _AE1NA	400...480V 3Ø	E94P040T4NEM*	*To order a drive that meets the ISO13849-1 safety standard replace the "M" in the part number with an "S"
MCS12H15-RSO	Resolver	EWLB_ _ _FE1NA _ _ _ = meter length (002, 005, 010)	EWLR_ _ _BE1NA	400...480V 3Ø	E94R040T4NRM*	

MCS12H35- with E94_040T4N_ _

Motor Models	Connectors Feedback	Intermediate Cables		Drives		
		Power	Feedback	Input Voltage	Drive Models	
MCS12H35-C40	Encoder	EWLB_ _ _FE1NA _ _ _ = meter length (002, 005, 010)	EWLE_ _ _AE1NA	400...480V 3Ø	E94P040T4NEM*	*To order a drive that meets the ISO13849-1 safety standard replace the "M" in the part number with an "S"
MCS12H35-RSO	Resolver	EWLB_ _ _FE1NA _ _ _ = meter length (002, 005, 010)	EWLR_ _ _BE1NA	400...480V 3Ø	E94R040T4NRM*	

Motor Speed - Torque Performance Curves

PositionServo with MCS Series Motors - 400/480 VAC - 120mm

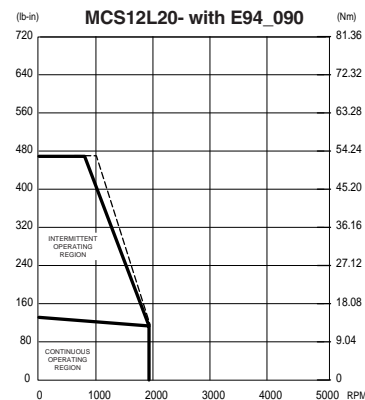
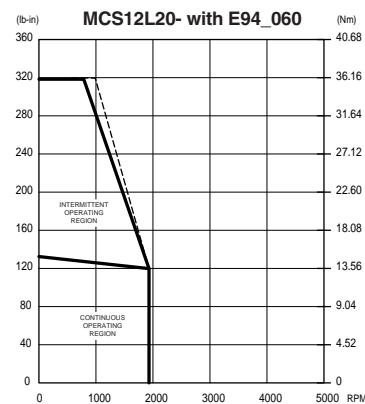
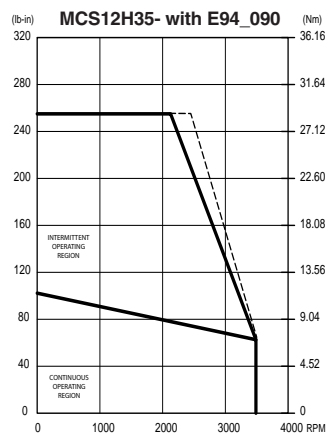
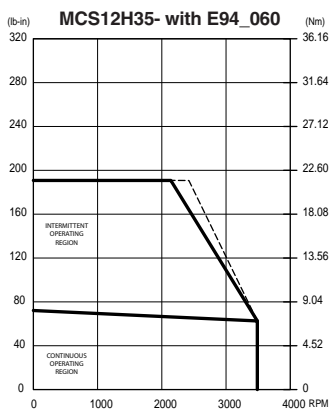

KEY:
 ——— 400 VAC
 - - - 480 VAC

MCS12H35- with E94_060T4N_ _

Motor Models	Connectors Feedback	Intermediate Cables		Drives		
		Power	Feedback	Input Voltage	Drive Models	
MCS12H35-C40	Encoder	EWLB_ _ _FE1NA _ _ _ = meter length (002, 005, 010)	EWLE_ _ _AE1NA	400...480V 3Ø	E94P060T4NEM*	*To order a drive that meets the ISO13849-1 safety standard replace the "M" in the part number with an "S"
MCS12H35-RSO	Resolver	EWLB_ _ _FE1NA _ _ _ = meter length (002, 005, 010)	EWLR_ _ _BE1NA	400...480V 3Ø	E94R060T4NRM*	

MCS12H35- with E94_090T4N_ _

Motor Models	Connectors Feedback	Intermediate Cables		Drives		
		Power	Feedback	Input Voltage	Drive Models	
MCS12H35-C40	Encoder	EWLB_ _ _FE1NA _ _ _ = meter length (002, 005, 010)	EWLE_ _ _AE1NA	400...480V 3Ø	E94P090T4NEM*	*To order a drive that meets the ISO13849-1 safety standard replace the "M" in the part number with an "S"
MCS12H35-RSO	Resolver	EWLB_ _ _FE1NA _ _ _ = meter length (002, 005, 010)	EWLR_ _ _BE1NA	400...480V 3Ø	E94R090T4NRM*	

MCS12L20- with E94_060T4N_ _

Motor Models	Connectors Feedback	Intermediate Cables		Drives		
		Power	Feedback	Input Voltage	Drive Models	
MCS12L20-C40	Encoder	EWLB_ _ _FE1NA _ _ _ = meter length (002, 005, 010)	EWLE_ _ _AE1NA	400...480V 3Ø	E94P060T4NEM*	*To order a drive that meets the ISO13849-1 safety standard replace the "X" in the part number with an "S"
MCS12L20-RSO	Resolver	EWLB_ _ _FE1NA _ _ _ = meter length (002, 005, 010)	EWLR_ _ _BE1NA	400...480V 3Ø	E94R060T4NRM*	

MCS12L20- with E94_090T4N_ _

Motor Models	Connectors Feedback	Intermediate Cables		Drives		
		Power	Feedback	Input Voltage	Drive Models	
MCS12L20-C40	Encoder	EWLB_ _ _FE1NA _ _ _ = meter length (002, 005, 010)	EWLE_ _ _AE1NA	400...480V 3Ø	E94P090T4NEM*	*To order a drive that meets the ISO13849-1 safety standard replace the "M" in the part number with an "S"
MCS12L20-RSO	Resolver	EWLB_ _ _FE1NA _ _ _ = meter length (002, 005, 010)	EWLR_ _ _BE1NA	400...480V 3Ø	E94R090T4NRM*	



Motor Speed - Torque Performance Curves

PositionServo with MCS Series Motors - 400/480 VAC - 120 and 140mm

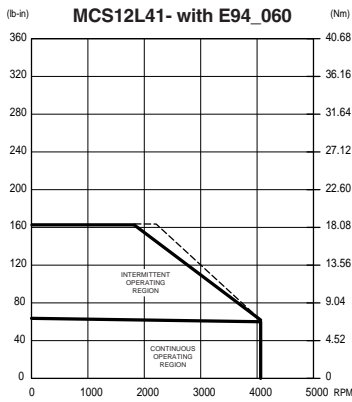

MCS12L41- with E94_060T4N_ _

Motor Models	Connectors Feedback	Intermediate Cables		Drives		
		Power	Feedback	Input Voltage	Drive Models	
MCS12L41-C40	Encoder	EWLB_ _ _FE1NA _ _ _ = meter length (002, 005, 010)	EWLE_ _ _AE1NA	400...480V 3Ø	E94P060T4NEM*	*To order a drive that meets the ISO13849-1 safety standard replace the "M" in the part number with an "S"
MCS12L41-RSO	Resolver	EWLB_ _ _FE1NA _ _ _ = meter length (002, 005, 010)	EWLR_ _ _BE1NA	400...480V 3Ø	E94R060T4NRM*	

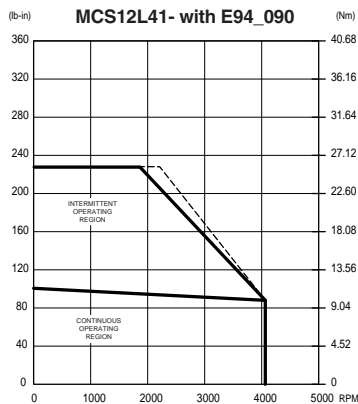

MCS12L41- with E94_090T4N_ _

Motor Models	Connectors Feedback	Intermediate Cables		Drives		
		Power	Feedback	Input Voltage	Drive Models	
MCS12L41-C40	Encoder	EWLB_ _ _FE1NA _ _ _ = meter length (002, 005, 010)	EWLE_ _ _AE1NA	400...480V 3Ø	E94P090T4NEM*	*To order a drive that meets the ISO13849-1 safety standard replace the "M" in the part number with an "S"
MCS12L41-RSO	Resolver	EWLB_ _ _FE1NA _ _ _ = meter length (002, 005, 010)	EWLR_ _ _BE1NA	400...480V 3Ø	E94R090T4NRM*	

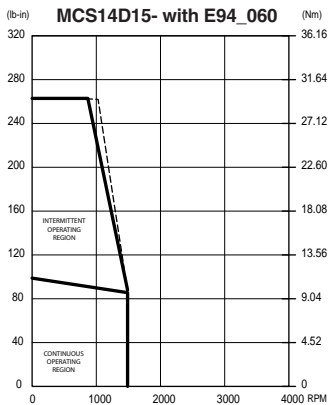

MCS14D15- with E94_060T4N_ _

Motor Models	Connectors Feedback	Intermediate Cables		Drives		
		Power	Feedback	Input Voltage	Drive Models	
MCS14D15-C40	Encoder	EWLB_ _ _FE1NA _ _ _ = meter length (002, 005, 010)	EWLE_ _ _AE1NA	400...480V 3Ø	E94P060T4NEM*	*To order a drive that meets the ISO13849-1 safety standard replace the "X" in the part number with an "S"
MCS14D15-RSO	Resolver	EWLB_ _ _FE1NA _ _ _ = meter length (002, 005, 010)	EWLR_ _ _BE1NA	400...480V 3Ø	E94R060T4NRM*	

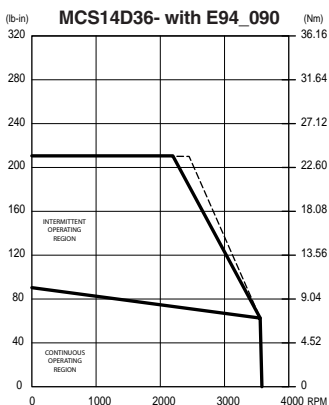

MCS14D36- with E94_090T4N_ _

Motor Models	Connectors Feedback	Intermediate Cables		Drives		
		Power	Feedback	Input Voltage	Drive Models	
MCS14D36-C40	Encoder	EWLB_ _ _FE1NA _ _ _ = meter length (002, 005, 010)	EWLE_ _ _AE1NA	400...480V 3Ø	E94P090T4NEM*	*To order a drive that meets the ISO13849-1 safety standard replace the "M" in the part number with an "S"
MCS14D36-RSO	Resolver	EWLB_ _ _FE1NA _ _ _ = meter length (002, 005, 010)	EWLR_ _ _BE1NA	400...480V 3Ø	E94R090T4NRM*	

KEY:
 ——— 400 VAC
 - - - 480 VAC



Motor Speed - Torque Performance Curves

PositionServo with MCS Series Motors - 400/480 VAC - 140mm

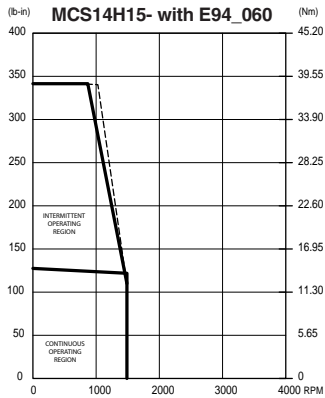

MCS14H15- with E94_060T4N__

Motor Models	Connectors Feedback	Intermediate Cables		Drives	
		Power	Feedback	Input Voltage	Drive Models
MCS14H15-C40	Encoder	EWLB__FE1NA ___ = meter length (002, 005, 010)	EWLE__AE1NA	400...480V 3Ø	E94P060T4NEM*
MCS14H15-RSO	Resolver	EWLB__FE1NA ___ = meter length (002, 005, 010)	EWLR__BE1NA	400...480V 3Ø	E94R060T4NRM*

*To order a drive that meets the ISO13849-1 safety standard replace the "M" in the part number with an "S"

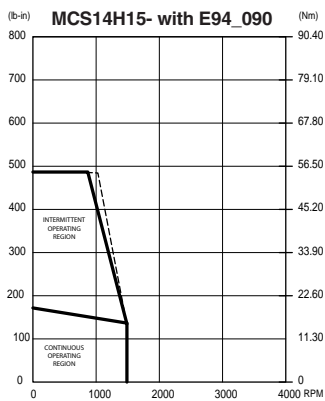

MCS14H15- with E94_090T4N__

Motor Models	Connectors Feedback	Intermediate Cables		Drives	
		Power	Feedback	Input Voltage	Drive Models
MCS14H15-C40	Encoder	EWLB__FE1NA ___ = meter length (002, 005, 010)	EWLE__AE1NA	400...480V 3Ø	E94P090T4NEM*
MCS14H15-RSO	Resolver	EWLB__FE1NA ___ = meter length (002, 005, 010)	EWLR__BE1NA	400...480V 3Ø	E94R090T4NRM*

*To order a drive that meets the ISO13849-1 safety standard replace the "M" in the part number with an "S"

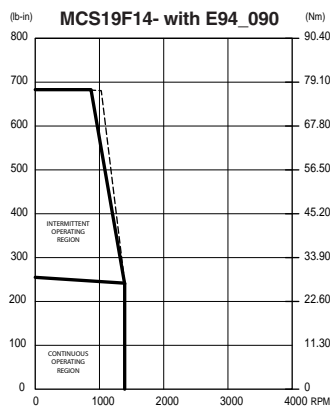

MCS19F14- with E94_090T4N__

Motor Models	Connectors Feedback	Intermediate Cables		Drives	
		Power	Feedback	Input Voltage	Drive Models
MCS19F14-C40	Encoder	EWLB__FE1NA ___ = meter length (002, 005, 010)	EWLE__AE1NA	400...480V 3Ø	E94P090T4NEM*
MCS19F14-RSO	Resolver	EWLB__FE1NA ___ = meter length (002, 005, 010)	EWLR__BE1NA	400...480V 3Ø	E94R090T4NRM*

*To order a drive that meets the ISO13849-1 safety standard replace the "M" in the part number with an "S"

KEY:
 ——— 400 VAC
 - - - 480 VAC

Motors without Fans

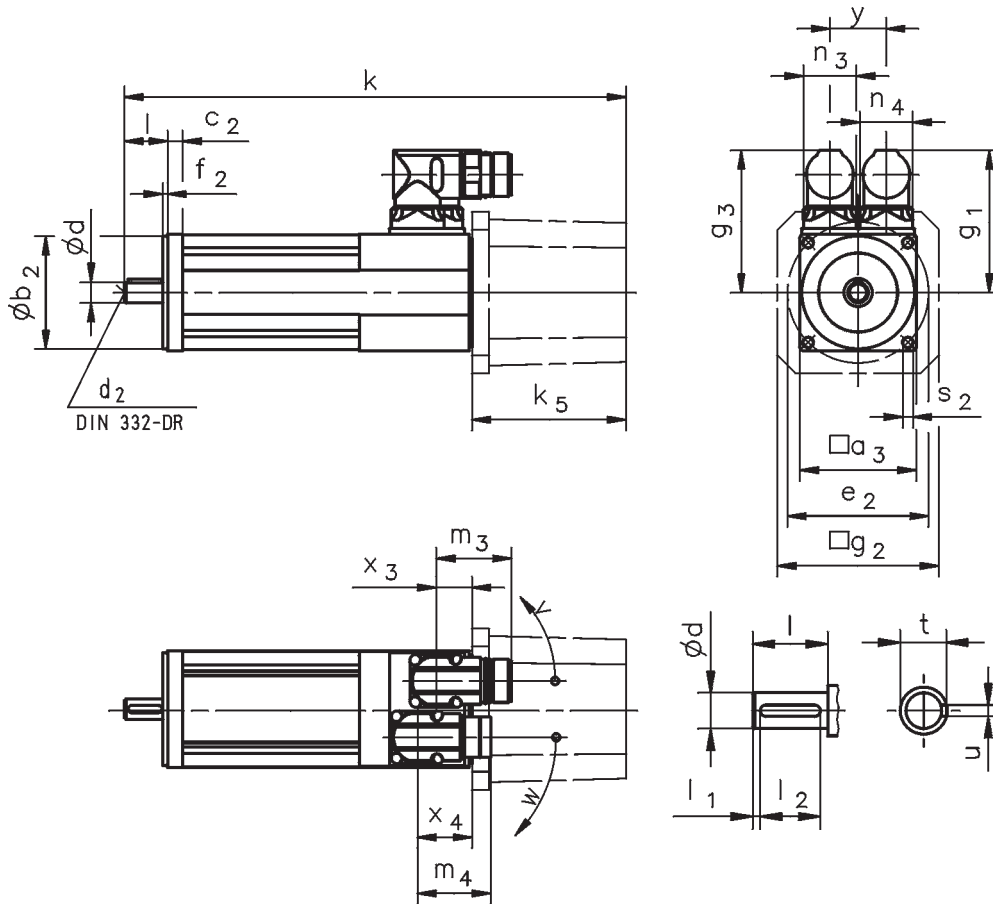

		MCS06C...	MCS06F...	MCS06I...
...RSO B0	k	155	185	215
...RSO P□	k	174	204	234
...RSO	k_5	0		
	g_2	-		
...SR□/E□□/C40 B0	k	237	267	297
...SR□/E□□/C40 P□	k	255	285	315
...SR□ / E□□ / C40	k_5	82		
	g_2	86		

	MCS06...
g_1	76
g_3	76
x_3	19
x_4	29
m_3	40
m_4	40
n_3	28
n_4	28
y	30
v	190°
w	230°

		MCS06...
d	k6	11
d_2		M4
l		23
l_1		2
l_2		18
t		12.5
u		4

		MCS06...
a_2		-
a_3		62
b_2	j6	60
c_2		8
e_2		75
f_2		2.5
s_2		5.5

Motors without Fans

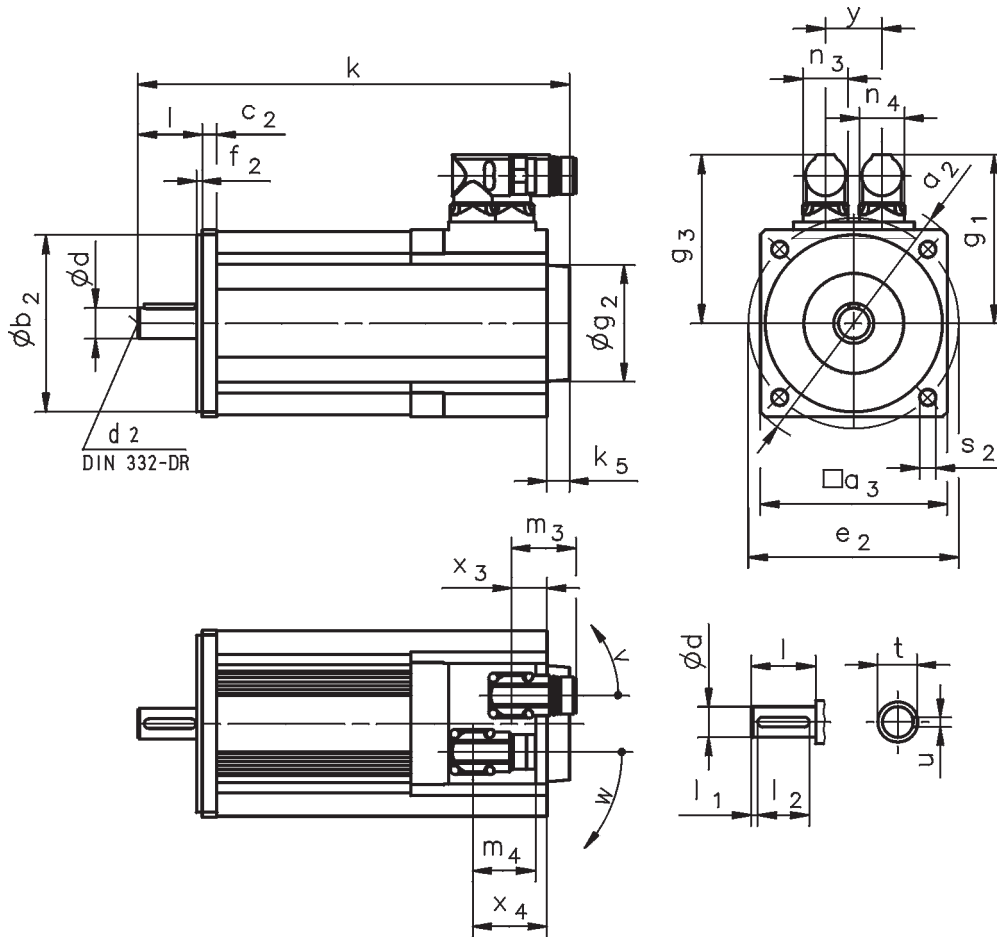

		MCS09D...	MCS09F...	MCS09H...	MCS09L...	MCS12D...	MCS12H...	MCS12L...
...RSO B0	k	213	233	253	293	228	268	308
...RSO P□	k	233	253	273	313	248	288	328
...RSO	k_5	13				14		
	g_2	67				72		
...SR□/E□□/ C40 B0	k	264	284	304	344	277	317	357
...SR□/E□□/ C40 P□	k	284	304	324	364	297	337	377
...SR□ / E□□ / C40	k_5	64				63		
	g_2	81				89		
		MCS14D...	MCS14H...	MCS14L...	MCS14P...	MCS19F...	MCS19J...	MCS19P...
...RSO B0	k	251	291	331	371	280	320	380
...RSO P□	k	279	319	359	399	314	364	424
...RSO	k_5	24				15		
	g_2	78				78		
...SR□/E□□/ C40 B0	k	301	341	381	421	329	369	429
...SR□/E□□/ C40 P□	k	329	369	409	449	363	413	473
...SR□ / E□□ / C40	k_5	74				64		
	g_2	101				101		



	MCS09...	MCS12...	MCS14D...	MCS14H...	MCS14L15	MCS14L32	MCS14P14
g_1	90	105	116	116	116	147	116
g_3	90	105	116	116	116	116	116
x_3	20	22	24	24	24	29	24
x_4	44	46	48	48	48	36	48
m_3	40	40	40	40	40	40	40
m_4	40	40	40	40	40	75	40
n_3	28	28	28	28	28	28	28
n_4	28	28	28	28	28	45	28
y	35	35	35	35	35	35	35
v	195°	195°	195°	195°	195°	180°	195°
w	260°	260°	260°	260°	260°	205°	260°

	MCS14P32	MCS19F14	MCS19F30	MCS19J14	MCS19J30	MCS19P14	MCS19P30
g_1	147	141	172	141	172	141	172
g_3	116	141	141	141	141	141	141
x_3	29	24	29	24	29	24	29
x_4	36	48	36	48	36	48	36
m_3	40	40	40	40	40	40	40
m_4	75	40	75	40	75	40	75
n_3	28	28	28	28	28	28	28
n_4	45	28	45	28	45	28	45
y	35	35	35	35	35	35	35
v	180°	195°	180°	195°	180°	195°	180°
w	205°	260°	205°	260°	205°	260°	205°

		MCS09...	MCS12...	MCS14...	MCS19...
d	k6	14	19	24	28
d_2		M5	M6	M8	M10
l		30	40	50	60
l_1		2.5	4	5	5
l_2		25	32	40	50
t		16	21.5	27	31
u		5	6	8	8

		MCS09...	MCS12...	MCS14...	MCS19...
a_2		120	160	188	250
a_3		89	116	143	192
b_2	j6	80	110	130	180
c_2		8	9	13	11
e_2		100	130	165	215
f_2		3	3.5	3.5	4
s_2		7	10	12	14

Motors with Blower

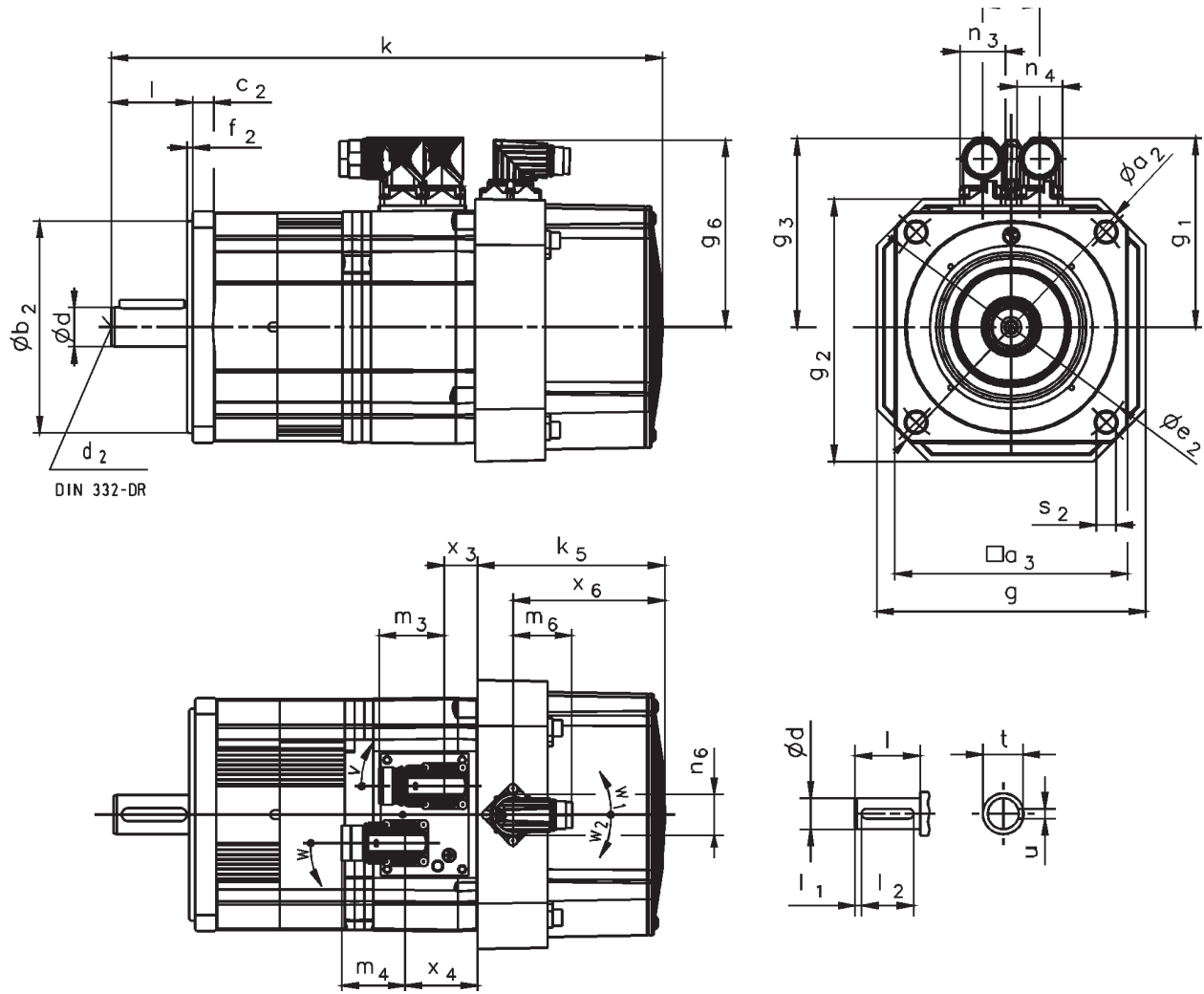

		MCS12D...	MCS12H...	MCS12L...	MCS14D...	MCS14H...
...RSO B0	k	301	341	381	339	379
...RSO P□	k	321	361	401	368	408
...RSO	k ₅		92		115	
...SR□/E□□/C40 B0	k	344	384	424	392	432
...SR□/E□□/C40 P□	k	364	404	444	421	461
...SR□ / E□□ / C40	k ₅		135		169	
	g		140		167	
	g ₂		140		163	
		MCS14L...	MCS14P...	MCS19F...	MCS19J...	MCS19P...
...RSO B0	k	419	459	387	427	487
...RSO P□	k	448	488	421	471	531
...RSO	k ₅	115			126	
...SR□/E□□/C40 B0	k	472	512	425	465	525
...SR□/E□□/C40 P□	k	501	541	459	509	569
...SR□ / E□□ / C40	k ₅	169			165	
	g	167			212	
	g ₂	163			210	



	MCS12...	MCS14D...	MCS14H12	MCS14H28	MCS14L14	MCS14L30	MCS14P11
g₁	105	116	147	116	147	116	147
g₃	105	116	116	116	116	116	116
g₆	107	115	115	115	115	115	115
x₃	16	21	24	21	24	21	24
x₄	40	45	31	45	31	45	31
x₆	67	93	93	93	93	93	93
m₃	40	40	40	40	40	40	40
m₄	40	40	75	40	75	40	75
m₆	37	37	37	37	37	37	37
n₃	28	28	28	28	28	28	28
n₄	28	28	45	28	45	28	45
n₆	28	28	28	28	28	28	28
y	35	35	35	35	35	35	35
v	160°	160°	170°	160°	170°	160°	170°
w	160°	160°	160°	160°	160°	160°	160°
w₁	120°	120°	120°	120°	120°	120°	120°
w₂	130°	130°	130°	130°	130°	130°	130°

	MCS14P26	MCS19F12	MCS19F29	MCS19J12	MCS19J29	MCS19P12	MCS19P29
g₁	116	141	172	172	172	172	172
g₃	116	141	141	141	141	141	141
g₆	115	148	148	148	148	148	148
x₃	21	19	24	24	24	24	24
x₄	45	43	31	31	31	31	31
x₆	93	96	96	96	96	96	96
m₃	40	40	40	40	40	40	40
m₄	40	40	75	75	75	75	75
m₆	37	37	37	37	37	37	37
n₃	28	28	28	28	28	28	28
n₄	28	28	45	45	45	45	45
n₆	28	28	28	28	28	28	28
y	35	35	35	35	35	35	35
v	160°	160°	170°	170°	170°	170°	170°
w	160°	160°	160°	160°	160°	160°	160°
w₁	120°	120°	120°	120°	120°	120°	120°
w₂	130°	130°	130°	130°	130°	130°	130°

		MCS12...	MCS14...	MCS19...
d	k6	19	24	28
d₂		M6	M8	M10
l		40	50	60
l₁		4	5	5
l₂		32	40	50
t		21.5	27	31
u		6	8	8

		MCS12...	MCS14...	MCS19...
a₂		160	188	250
a₃		116	143	192
b₂	j6	110	130	180
c₂		9	13	11
e₂		130	165	215
f₂		3.5	3.5	4
s₂		10	12	14

Motors with Terminal Box

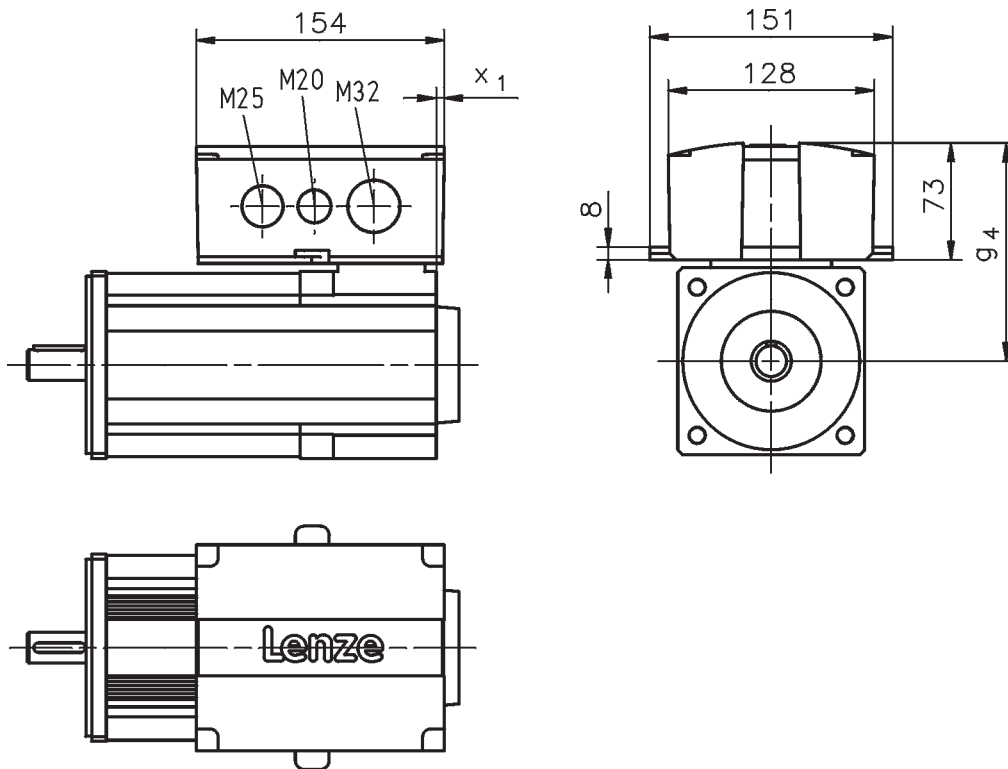

	MCS09...S00	MCS12...S00	MCS14...S00	MCS19...S00
g_4	121	136	147	172
x_1	8	5	3	



MD Series

Low Inertia, Higher Power

The MDS Series of motors are similar to the MCS motors and are characterized by an extremely low moment of inertia and an incredibly high overload capacity. The motors are designed 400/480 VAC demanding applications that require resolver feedback.

MD Series Features

- Synchronous AC brushless servo motors
- 250W to 5.9kW Power
- 480 VAC
- Resolver feedback
- UL, CE
- IP54
- Optional IP65
- Intercontec connectors
- 6-pole
- Optional 24VDC brake
- Two-year warranty

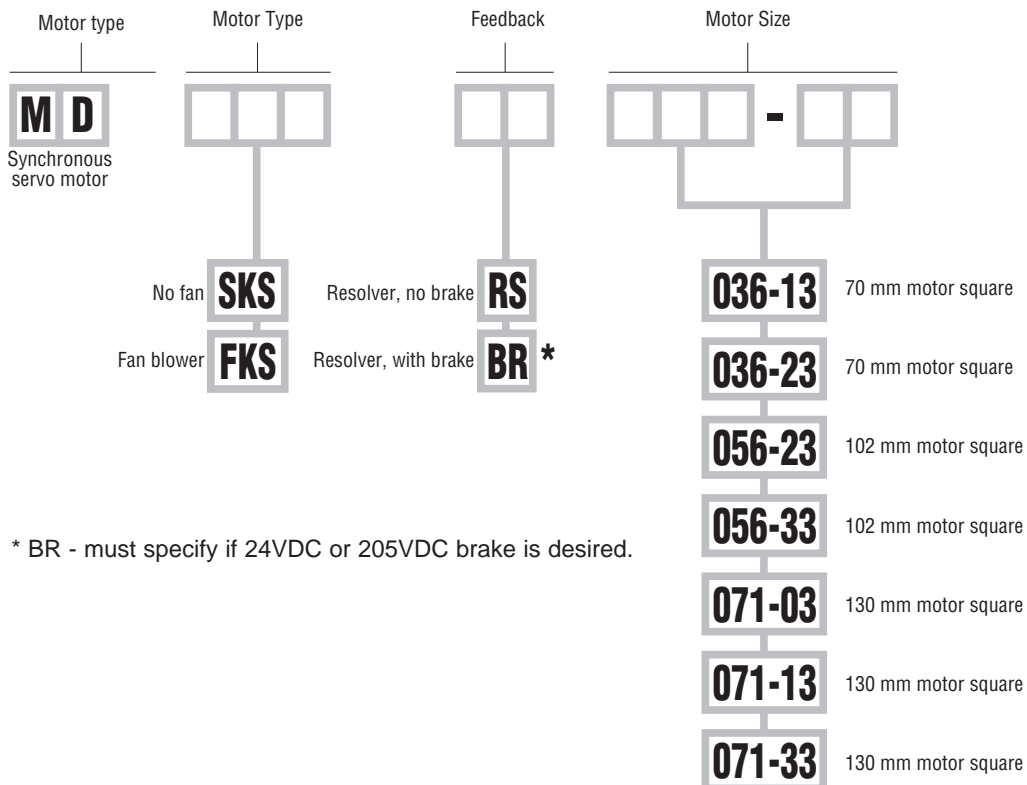

* BR - must specify if 24VDC or 205VDC brake is desired.



MD Specifications - 480VAC

Parameter*	Units	MDSKS__036-13	MDSKS__036-23	MDSKS__056-23	MDSKS__056-33
Maximum bus voltage	VDC	680	680	680	680
Rated power	kW	0.25	0.54	1.1	1.8
Rated speed	RPM	4000	4000	3800	4000
Maximum speed*	RPM	8000	8000	5500	5500
Rated torque	N-m	0.6	1.3	2.8	4.2
	lb-In	5.31	11.50	24.78	37.17
Continuous stall torque	N-m	0.7	1.5	3.2	4.7
	lb-In	6.19	13.27	28.32	41.59
Peak torque	N-m	3.1	7.2	11.6	17.2
	lb-In	27.43	63.72	102.65	152.21
Rated current	Arms	0.9	1.1	2.3	3.6
Continuous stall current	Arms	0.9	1.3	2.6	4
Peak current	Arms	5	7.5	10	16
Torque constant at 150°C K _t	N-m/Arms	0.72	1.2	1.23	1.18
	lb-In/Arms	6.37	10.62	10.88	10.44
Voltage constant K _e (ph-ph)	V/kRPM	47.2	74.5	78.1	74.6
Rotor inertia	kg · m ²	2.20E-5	3.60E-5	1.20E-4	1.80E-4
	lbs-In-sec ²	1.95E-4	3.19E-4	1.06E-3	1.59E-3
Motor weight	kg	1.5	2.1	5.3	6.3
	lb	3.31	4.63	11.69	13.89
Motor poles		8			

Parameter*	Units	MDSKS__071-03	MDSKS__071-13	MDSKS__071-33	MDFKS__071-03	MDFKS__071-13	MDFKS__071-33
Maximum bus voltage	VDC	680	680	680	680	680	680
Rated power	kW	2	3.2	4.6	2.6	4.1	5.9
Rated speed	RPM	3400	3700	3600	3300	3600	3500
Maximum speed*	RPM	5000	5000	5000	5000	5000	5000
Rated torque	N-m	5.7	8.3	12.3	7.7	11.7	17
	lb-In	50.44	73.45	108.85	68.14	103.54	150.44
Continuous stall torque	N-m	6.7	10	14.7	8.8	13.3	19.3
	lb-In	59.29	88.50	130.09	77.88	117.70	170.80
Peak torque	N-m	23.6	35.2	52	23.6	35.2	52
	lb-In	208.85	311.50	460.18	208.85	311.50	460.18
Rated current	Arms	4.2	7	10	5.6	9.2	13.1
Continuous stall current	Arms	4.90	8.40	11.9	6.6	11.1	15.6
Peak current	Arms	19	32	45	19	32	45
Torque constant at 150°C K _t	N-m/Arms	1.37	1.19	1.24	1.33	1.2	1.24
	lb-In/Arms	12.12	10.53	10.97	11.77	10.62	10.97
Voltage constant K _e (ph-ph)	V/kRPM	93.00	84.50	88.2	93	84.5	88.2
Rotor inertia	kg · m ²	6.00E-4	8.00E-4	1.00E-3	6.00E-4	8.00E-4	1.00E-3
	in-lbs-sec ²	5.31E-3	7.08E-3	8.85E-3	5.31E-3	7.08E-3	8.85E-3
Motor weight	kg	8.90	10.90	13	10.2	12.2	12.2
	lb	19.62	24.03	28.66	22.49	26.90	26.90
Motor poles		8					

* Motor performance does not always reflect system performance. System performance can be found in the following speed-torque curves.



Motor Speed - Torque Performance Curves

PositionServo with MD Series Motors - 480 VAC - 70 and 102mm

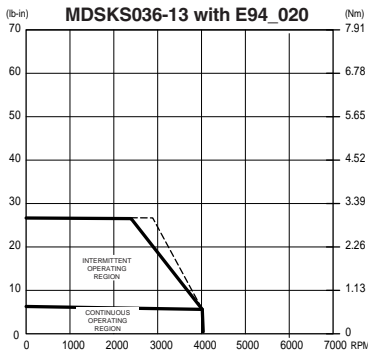

MDSKS__036-13 with E94_020T4N__

Motor Models	Brake	Intermediate Cables		Drives		
		Power	Feedback	Input Voltage	Drive Models	
MDSKSB036-13	Brake	EWLB__FE1NA ___ = meter length (002, 005, 010)	EWLR__BE1NA	400...480V 3Ø	E94R020T4NRM*	*To order a drive that meets the ISO13849-1 safety standard replace the "M" in the part number with an "S"
MDSKSR036-13	No Brake	EWLB__FE1NA ___ = meter length (002, 005, 010)	EWLR__BE1NA	400...480V 3Ø	E94R020T4NRM*	

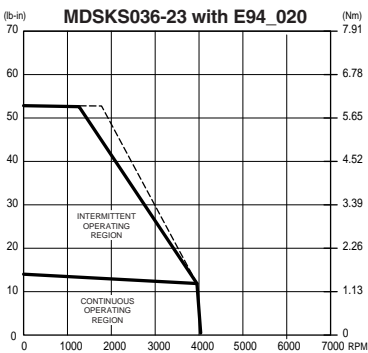

MDSKS__036-23 with E94_020T4N__

Motor Models	Brake	Intermediate Cables		Drives		
		Power	Feedback	Input Voltage	Drive Models	
MDSKSB036-23	Brake	EWLB__FE1NA ___ = meter length (002, 005, 010)	EWLR__BE1NA	400...480V 3Ø	E94R020T4NRM*	*To order a drive that meets the ISO13849-1 safety standard replace the "M" in the part number with an "S"
MDSKSR036-23	No Brake	EWLB__FE1NA ___ = meter length (002, 005, 010)	EWLR__BE1NA	400...480V 3Ø	E94R020T4NRM*	

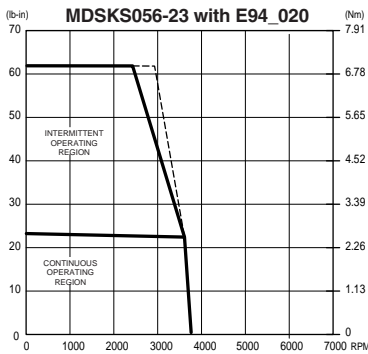

MDSKS__056-23 with E94_020T4N__

Motor Models	Brake	Intermediate Cables		Drives		
		Power	Feedback	Input Voltage	Drive Models	
MDSKSB056-23	Brake	EWLB__FE1NA ___ = meter length (002, 005, 010)	EWLR__BE1NA	400...480V 3Ø	E94R020T4NRM*	*To order a drive that meets the ISO13849-1 safety standard replace the "M" in the part number with an "S"
MDSKSR056-23	No Brake	EWLB__FE1NA ___ = meter length (002, 005, 010)	EWLR__BE1NA	400...480V 3Ø	E94R020T4NRM*	

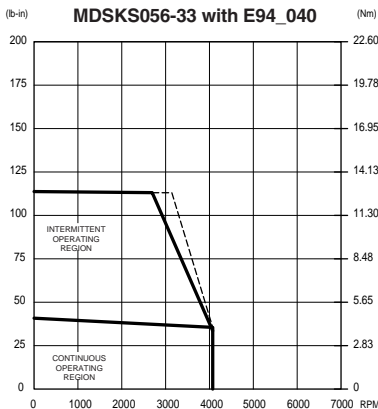

MDSKS__056-33 with E94_040T4N__

Motor Models	Brake	Intermediate Cables		Drives		
		Power	Feedback	Input Voltage	Drive Models	
MDSKSB056-33	Brake	EWLB__FE1NA ___ = meter length (002, 005, 010)	EWLR__BE1NA	400...480V 3Ø	E94R040T4NRM*	*To order a drive that meets the ISO13849-1 safety standard replace the "M" in the part number with an "S"
MDSKSR056-33	No Brake	EWLB__FE1NA ___ = meter length (002, 005, 010)	EWLR__BE1NA	400...480V 3Ø	E94R040T4NRM*	

Motor Speed - Torque Performance Curves

PositionServo with MD Series Motors - 480 VAC - 130mm

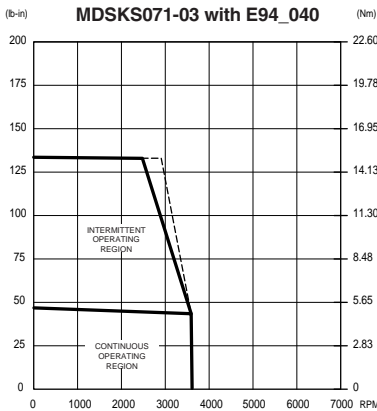

MDSKS__071-03 with E94_040T4N__

Motor Models	Brake	Intermediate Cables		Drives		
		Power	Feedback	Input Voltage	Drive Models	
MDSKSBR071-03	Brake	EWLB__FE1NA ___ = meter length (002, 005, 010)	EWLR__BE1NA	400...480V 3Ø	E94R040T4NRM*	*To order a drive that meets the ISO13849-1 safety standard replace the "M" in the part number with an "S"
MDSKSRS071-03	No Brake	EWLB__FE1NA ___ = meter length (002, 005, 010)	EWLR__BE1NA	400...480V 3Ø	E94R040T4NRM*	

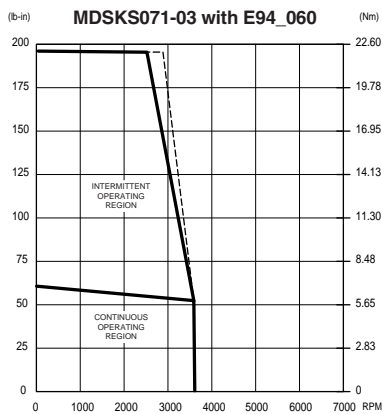

MDSKS__071-03 with E94_060T4N__

Motor Models	Brake	Intermediate Cables		Drives		
		Power	Feedback	Input Voltage	Drive Models	
MDSKSBR071-03	Brake	EWLB__FE1NA ___ = meter length (002, 005, 010)	EWLR__BE1NA	400...480V 3Ø	E94R060T4NRM*	*To order a drive that meets the ISO13849-1 safety standard replace the "M" in the part number with an "S"
MDSKSRS071-03	No Brake	EWLB__FE1NA ___ = meter length (002, 005, 010)	EWLR__BE1NA	400...480V 3Ø	E94R060T4NRM*	

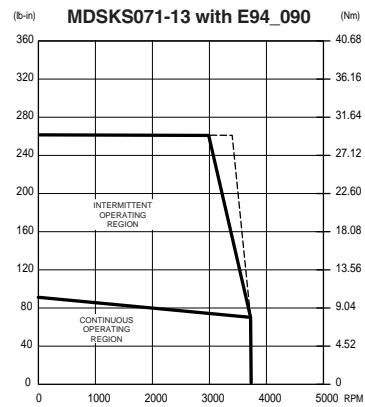

MDSKS__071-13 with E94_090T4N__

Motor Models	Brake	Intermediate Cables		Drives		
		Power	Feedback	Input Voltage	Drive Models	
MDSKSBR071-13	Brake	EWLB__FE1NA ___ = meter length (002, 005, 010)	EWLR__BE1NA	400...480V 3Ø	E94R090T4NRM*	*To order a drive that meets the ISO13849-1 safety standard replace the "M" in the part number with an "S"
MDSKSRS071-13	No Brake	EWLB__FE1NA ___ = meter length (002, 005, 010)	EWLR__BE1NA	400...480V 3Ø	E94R090T4NRM*	

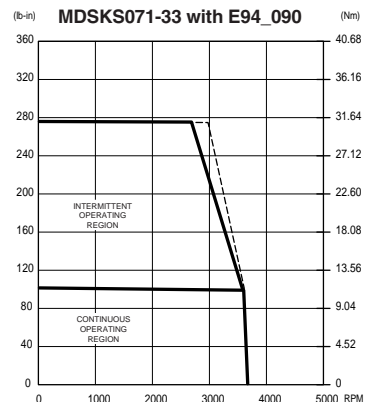

MDSKS__071-33 with E94_090T4N__

Motor Models	Brake	Intermediate Cables		Drives		
		Power	Feedback	Input Voltage	Drive Models	
MDSKSBR071-33	Brake	EWLB__FE1NA ___ = meter length (002, 005, 010)	EWLR__BE1NA	400...480V 3Ø	E94R090T4NRM*	*To order a drive that meets the ISO13849-1 safety standard replace the "M" in the part number with an "S"
MDSKSRS071-33	No Brake	EWLB__FE1NA ___ = meter length (002, 005, 010)	EWLR__BE1NA	400...480V 3Ø	E94R090T4NRM*	

Motor Speed - Torque Performance Curves

PositionServo with MD Series Motors - 480 VAC - 130mm

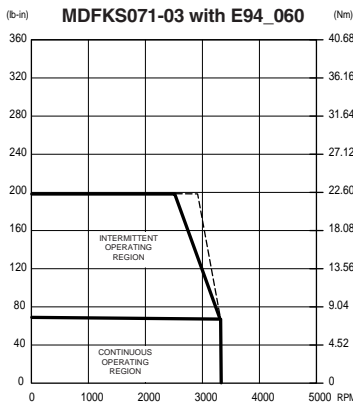

MDFKS_071-03 with E94_060T4N_

Motor Models	Brake	Intermediate Cables		Drives		
		Power	Feedback	Input Voltage	Drive Models	
MDFKSBR071-03	Brake	EWLB_ _FE1NA _ _ _ = meter length (002, 005, 010)	EWLR_ _BE1NA	400...480V 3Ø	E94R060T4NRM*	*To order a drive that meets the ISO13849-1 safety standard replace the "M" in the part number with an "S"
MDFKSRS071-03	No Brake	EWLB_ _FE1NA _ _ _ = meter length (002, 005, 010)	EWLR_ _BE1NA	400...480V 3Ø	E94R060T4NRM*	

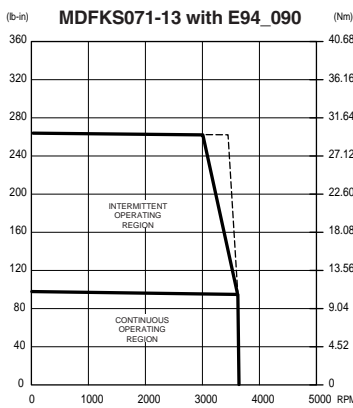

MDFKS_071-13 with E94_090T4N_

Motor Models	Brake	Intermediate Cables		Drives		
		Power	Feedback	Input Voltage	Drive Models	
MDFKSBR071-13	Brake	EWLB_ _FE1NA _ _ _ = meter length (002, 005, 010)	EWLR_ _BE1NA	400...480V 3Ø	E94R090T4NRM*	*To order a drive that meets the ISO13849-1 safety standard replace the "M" in the part number with an "S"
MDFKSRS071-13	No Brake	EWLB_ _FE1NA _ _ _ = meter length (002, 005, 010)	EWLR_ _BE1NA	400...480V 3Ø	E94R090T4NRM*	

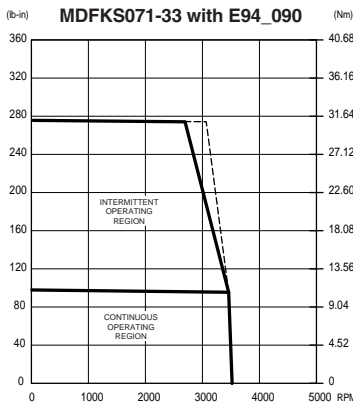

MDFKS071-33 with E94_090T4N_

Motor Models	Brake	Intermediate Cables		Drives		
		Power	Feedback	Input Voltage	Drive Models	
MDFKSBR071-33	Brake	EWLB_ _FE1NA _ _ _ = meter length (002, 005, 010)	EWLR_ _BE1NA	400...480V 3Ø	E94R090T4NRM*	*To order a drive that meets the ISO13849-1 safety standard replace the "M" in the part number with an "S"
MDFKSRS071-33	No Brake	EWLB_ _FE1NA _ _ _ = meter length (002, 005, 010)	EWLR_ _BE1NA	400...480V 3Ø	E94R090T4NRM*	

Motors Without Fans

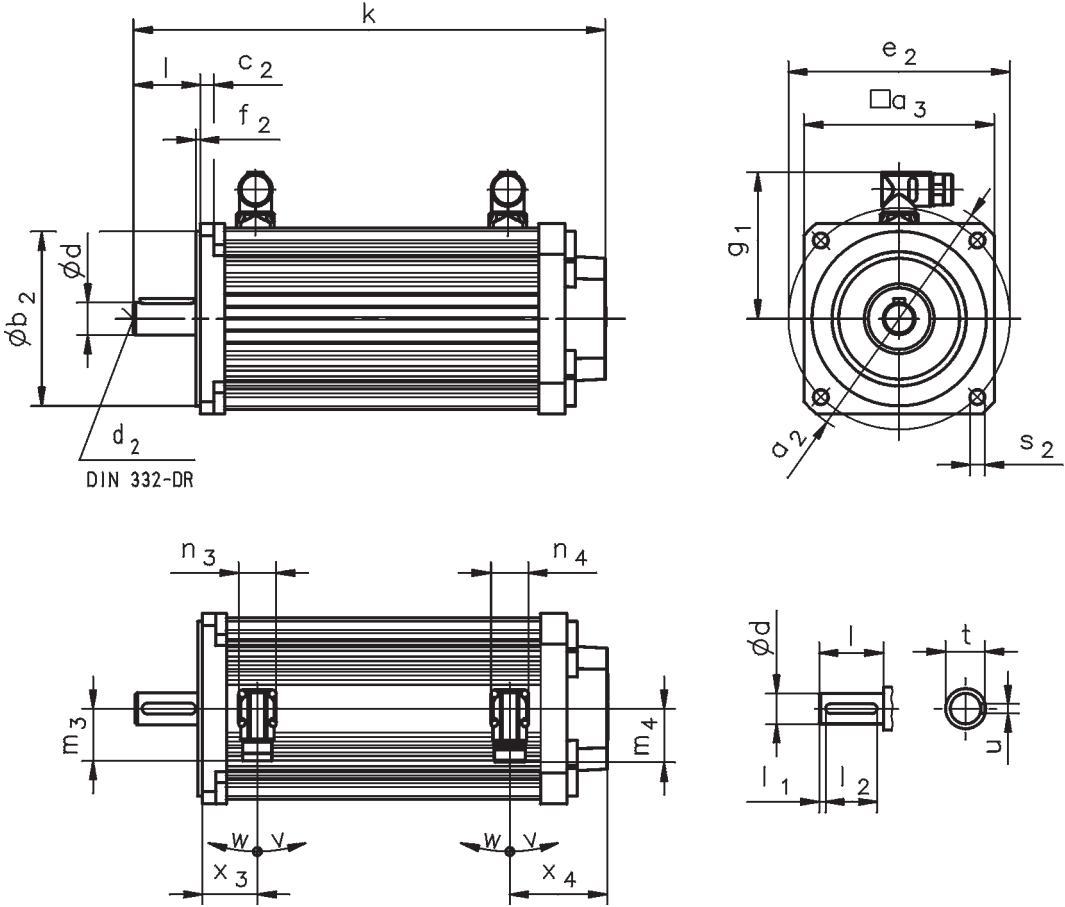

MDSKS□□		036-13	036-23	056-23	056-33	071-03	071-13	071-33
RS	k	166	190	240.5	275.5	259	294	329
	x ₃	81	105	34		37		
	x ₄	22		58		56.5		



MDSKS□□			036-13	056-23	071-03
			036-23	056-33	071-13
			071-33		
	g_1		76.5	89.5	102
	n_3			28	
	n_4			28	
	m_3			40	
	m_4			40	
	v			195 °	
	w			80 °	

MDSKS□□			036-13	056-23	071-03
			036-23	056-33	071-13
			071-33		
	d	k6	11	14	19
	d_2		M4	M5	M6
	l		23	30	40
	l_1		3	2.5	2
	l_2		18	25	36
	u		4	5	6
	t		12.5	16	21.5

MDSKS□□			036-13	056-23	071-03		
			036-23	056-33	071-13		
			071-33				
			B5	B14	B5	B14	
				A120	C105	A160	C160
			FF75	FF100	FT85	FF130	FT130
	a_2		87	120	160		
	a_3		70	102	130		
	b_2	j6	60	80	70	110	
	c_2		14	8	9		
	e_2		75	100	85	130	
	f_2		2.5	3	2.5	3.5	
	s_2		6	7	M6	9	M8

Motors with Blower

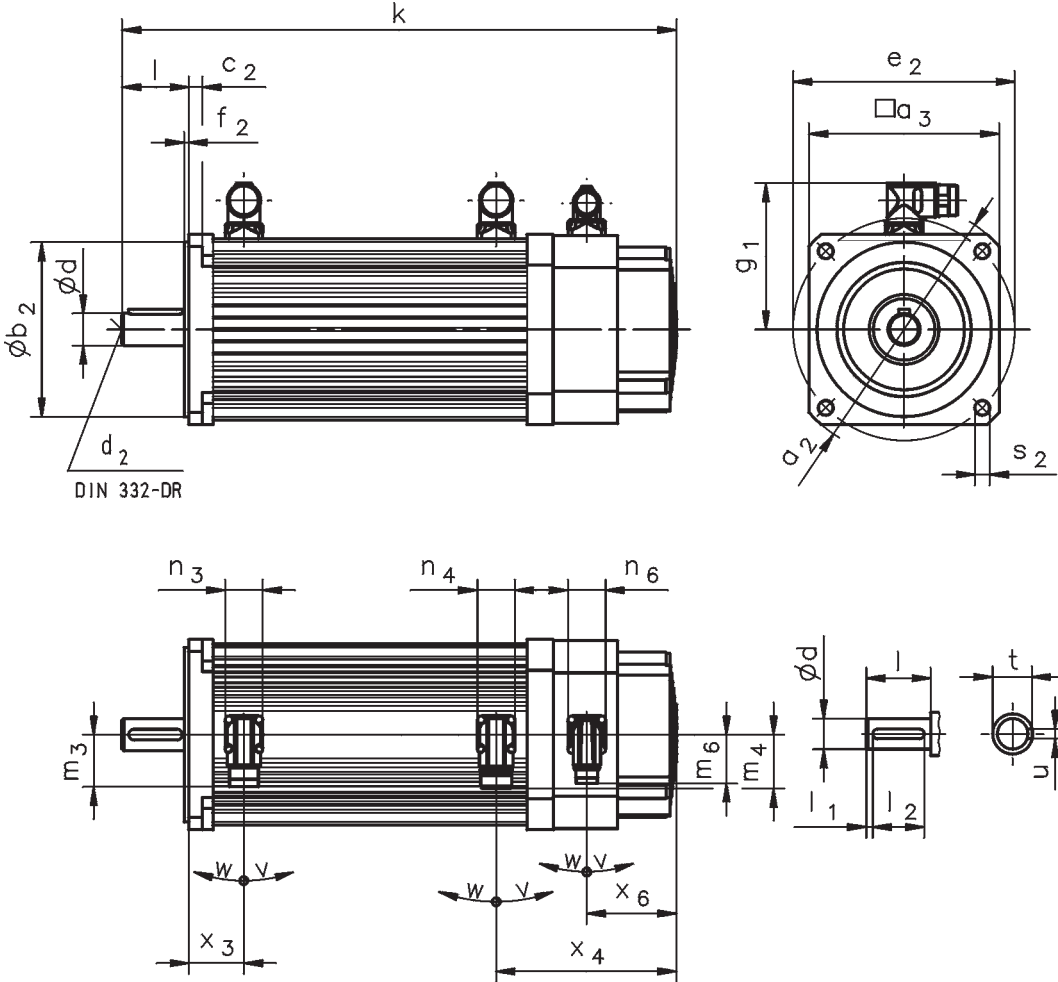

MDFKS□□		071-03	071-13	071-33
RS	k	327	362	397
	x ₃		37	
	x ₄		124.5	
	x ₆		73	



MDFKS□□			071-03
			071-13
			071-33
	g₁		102
	n₃		28
	n₄		28
	n₆		28
	m₃		40
	m₄		40
	m₆		37
	v		195 °
	w		80 °

MDFKS□□			071-03
			071-13
			071-33
	d	k6	19
	d₂		M6
	l		40
	l₁		2
	l₂		36
	u		6
	t		21.5

MDFKS□□			071-03	
			071-13	
			071-33	
			B5	B14
			A160	C160
			FF130	FT130
	a₂		160	
	a₃		130	
	b₂	j6	110	
	c₂		9	
	e₂		130	
	f₂		3.5	
	s₂		9	M8

Motors with Terminal Box

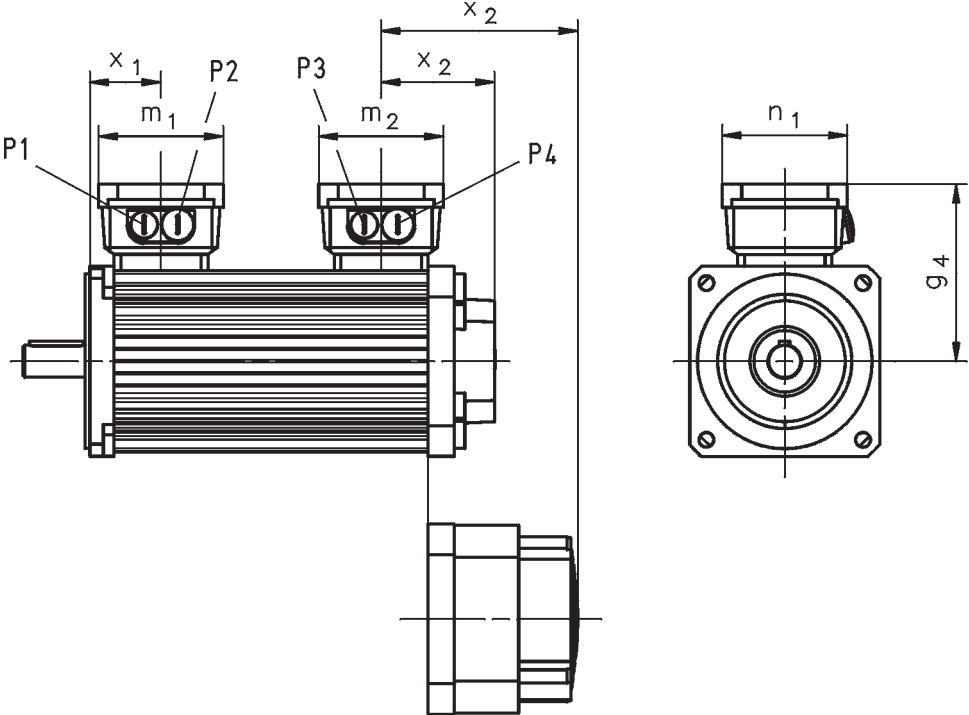

MDSKS□□		056-23	056-33	071-03	071-13	071-33
MDFKS□□				071-03	071-13	071-33
	g_4	109		121		
	m_1	93				
	m_2	93				
	n_1	93				
	x_1	54		57		
	P1	M16x1.5				
	P2	M20x1.5				
	P3	M16x1.5				
	P4	M20x1.5				
MDSKS□□		056-23	056-33	071-03	071-13	071-33
RS	x_2	63	78	68.5	76.5	
MDFKS□□		071-03		071-13	071-33	
RS	x_2	136.5		144.5		



The PositionServo offers numerous accessories to complete your motion control system. The following pages describe all of the options available to you:

- EPM Programmer
- Communication Modules
- Breakout Modules
- EMC Filters
- Dynamic Braking Resistors

EPM Programmer and Accessories

EPM Programmer	
Item Number	Description
EEPM1RA	EPM Programmer
EEPM2WA	White EPM bulk pack (12)

The EPM - Your Unique Advantage

The EPM (Electronic Programming Module) is your drive's removable memory chip.

EPM Advantages

- Quickly duplicate complete servo configuration files.
- After initial set-up, configure more servos without prior servo knowledge or without needing to power up the drive.
- To update a servo in the field, simply remove the current EPM and replace it with a new EPM.





Communication and Breakout Modules

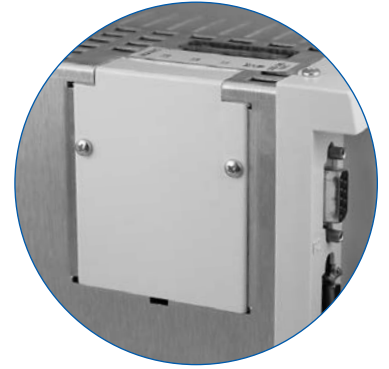

Communication Modules	
Item Number	Description
E94ZACAN1	CANopen Communication Module
E94ZARS41	RS-485 Communication Module
E94ZADVN1	DeviceNet Communication Module
E94ZAPFB1	PROFIBUS-DP Communication Module

Breakout Modules	
Item Number	Description
E94ZAHBK2	Motor Brake Terminal Block & SCSI [F] I/O Module
E94ZATBO2	Terminal Block I/O Module
E94ZASCA2	Panel Saver SCSI [F] I/O Module for Encoder
E94ZASCA3	Panel Saver Module for Resolver



CANopen Communication Module



RS-485 Communication Module



DeviceNet Communication Module



PROFIBUS-DP Communication Module

Designation Codes:

	E94Z	A	CAN	1
Electrical Option in the PositionServo				
Option Type				
A = Communication, Feedback or Breakout Module				
Option Type (Option Type A):				
CAN = CANopen Communication Module				
RS4 = RS-485 Communication Module				
DVN = DeviceNet Communication Module				
PFB = PROFIBUS-DP Communication Module				
HBK = Motor Brake Terminal Block I/O Module				
TBO = Terminal Block I/O Module				
SCA = Panel Saver I/O Module				
Variations:				
1 = 1st Variation, 2 = 2nd Variation, . . .				

Breakout Module

Item Number	Description
E94ZATB02	50-Pin Screw Terminal Block, PositionServo

Dimensions are in mm

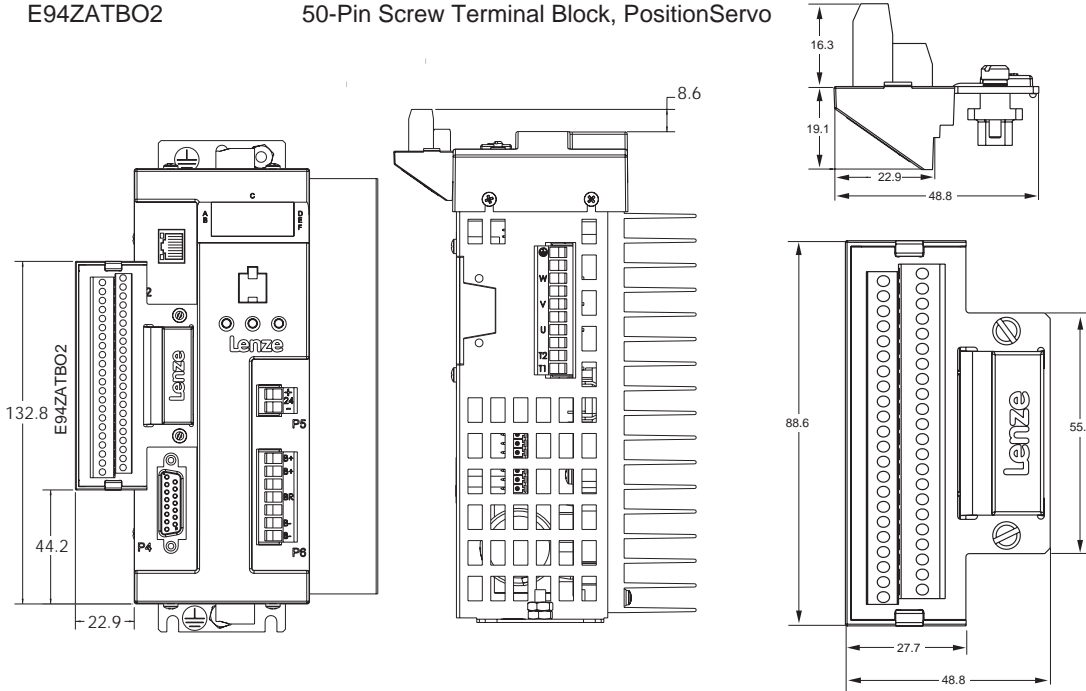

- Direct wiring to screw terminals for all 50 pins on the P3 Controller Interface
- Excellent for accessing individual control I/O for test or ease of installation

Breakout Module

Item Number	Description
E94ZASCA2	Panel Saver Module with SCSI [F] I/O connection and DB15 Encoder connection, PositionServo 940
E94ZASCA3	Panel Saver Module with SCSI [F] I/O connection and DB9 Resolver connection, PositionServo 941

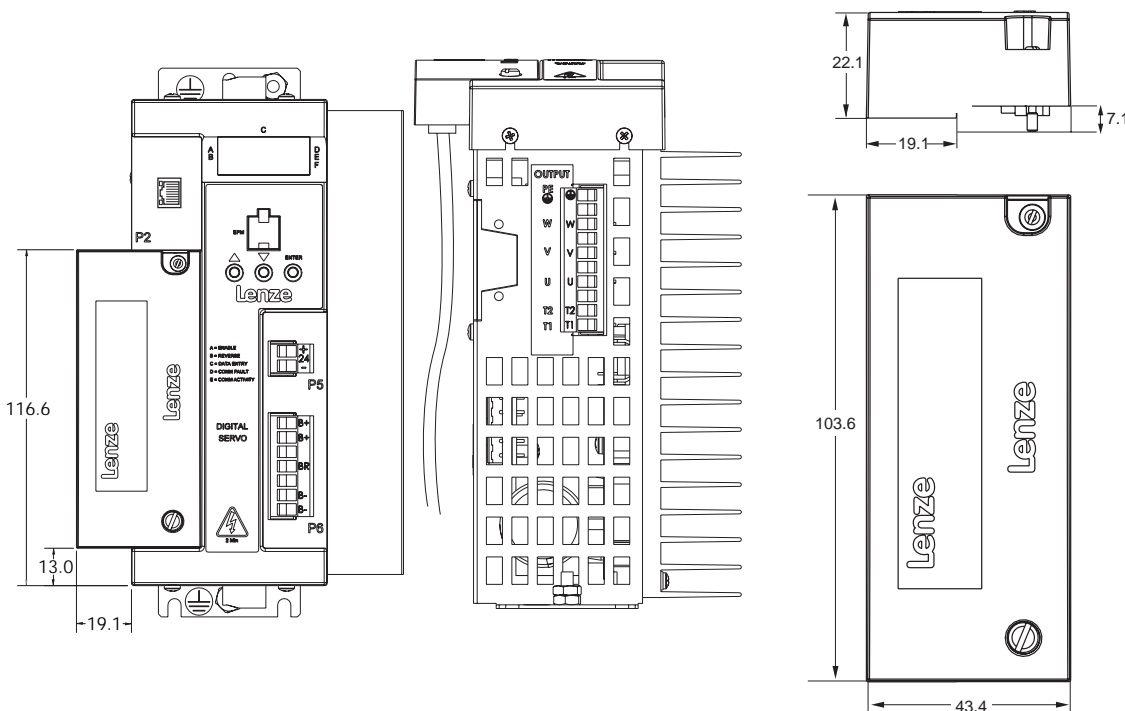

- Mounts directly to the face of the drive and provides alternate connection points to the P3 and P4 connectors
- Allows for control cabling to be routed parallel to the drive for applications where panel depth is a concern

Breakout Module

Item Number

E94ZAHBK2

Description

50-Pin SCSI Connector with 4-Pin Screw Terminal for Motor Brake

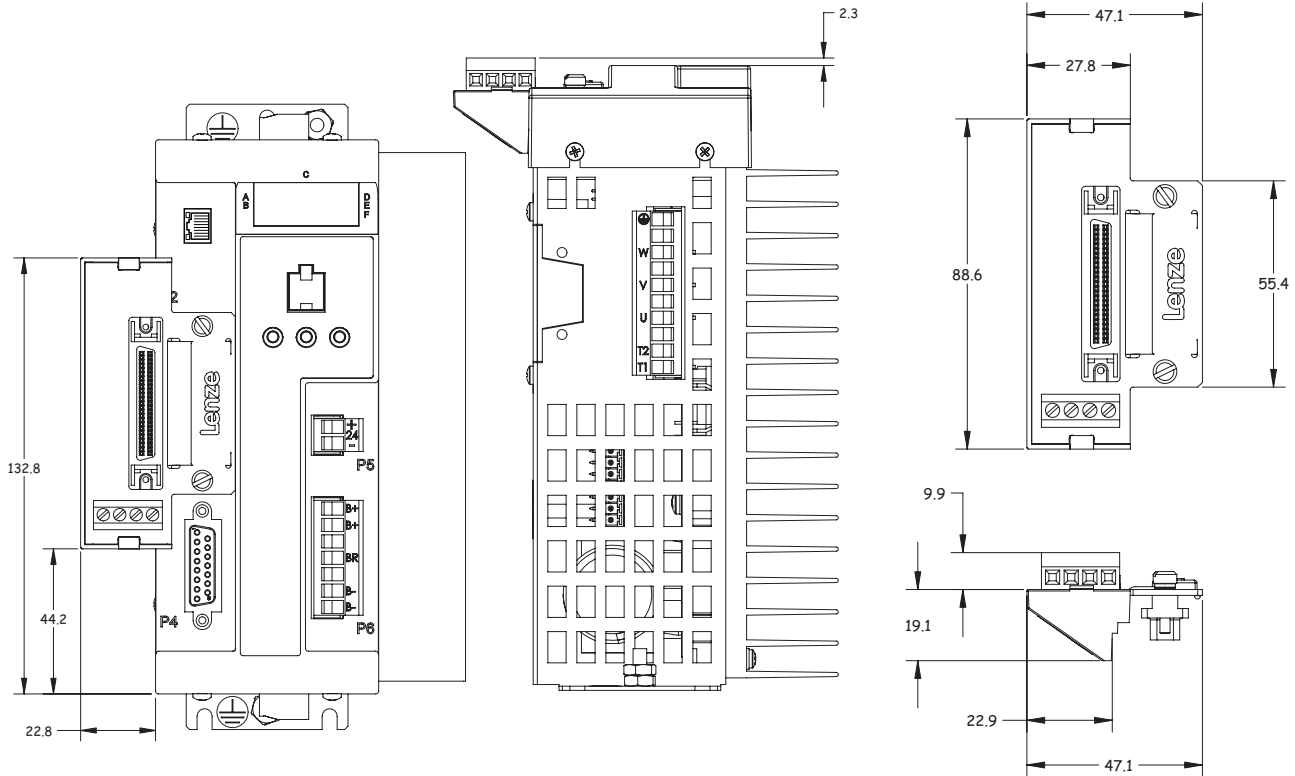

- Mounts directly to P3 controller interface connector and provides screw terminal access to supply 24VDC for controlling a motor holding brake.
- Output 2 is dedicated for controlling motor holding brake functions via the 4-pin screw terminal. The additional control I/O pins from P3 are accessible via the 50-pin SCSI connector located at P3A.



PositionServo EMC Filters:

EMC Filters				
Mounting	Item Number	Compatible Drives	Phase	Filter Output Current [In]
Footprint	E94ZF04T4A1	E94_020Y2N, E94_020T4N	3Ø Only	4.4
Footprint	E94ZF07T4A1	E94_040Y2N, E94_040T4N	3Ø Only	6.9
Footprint	E94ZF15T4A1	E94_080Y2N	3Ø Only	15
Footprint	E94ZF15T4A2	E94_100Y2N	3Ø Only	15
Side Mount	E94ZF10T4A1	E94_060T4N	3Ø Only	10.0
Side Mount	E94ZF12T4A2	E94_090T4N	3Ø Only	12.0
Side Mount	E94ZF24S2A1	E94_120Y2N	1Ø Only	24.0

EMC Filters Designation Code:

	E94Z	F	04	T	4	A1
Electrical Option in the PositionServo						
Filter Type: F = EMC Filter						
Filter Current Rating in Amps 04 = 4.4 Amps 07 = 6.9 Amps 10 = 10 Amps 12 = 12 Amps 15 = 15 Amps 24 = 24 Amps						
Input Phase S = Single Phase T = Three Phase						
Maximum Voltage: 2 = 240 VAC 4 = 400/480 VAC						
Degree of Filtering/Variation A1 = Industrial/1st Variation A2 = Industrial/2nd Variation						

Footprint Filter

Dimensions are in mm

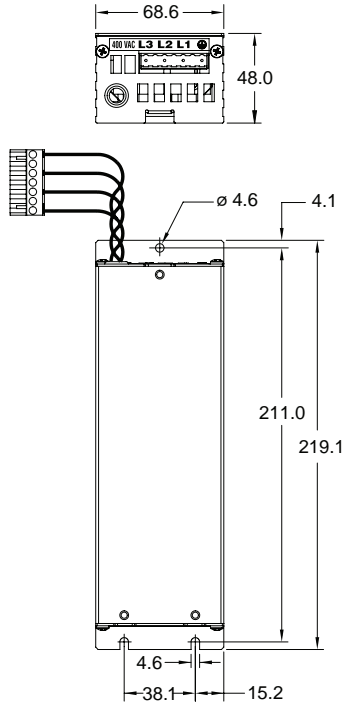

Model Number	Drive Compatibility	I _n (A)	m (kg)
E94ZF04T4A1	E94_020Y2N, E94_020T4N	4.4	0.8
E94ZF07T4A1	E94_040T2N, E94_040T4N	6.9	
E94ZF15T4A1	E94_080Y2N	15.0	
E94ZF15T4A2	E94_100Y2N	15.0	

Sidemount Filter

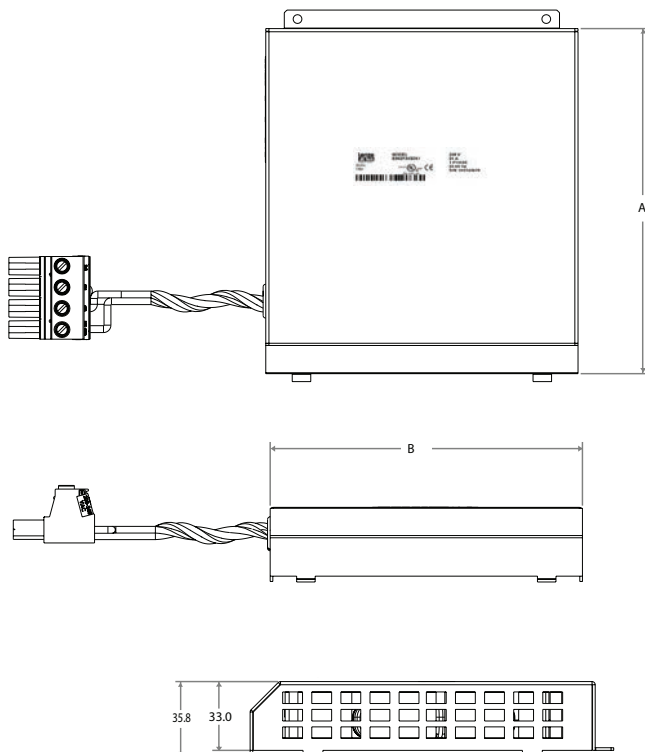

Model Number	Drive Compatibility	A (mm)	B (mm)	I _n (A)	m (kg)
E94ZF24S2A1	E94_120Y2N (1Ø)	165.6	149.9	24.0	0.6
E94ZF10T4A1	E94_060T4N	165.6	149.9	10.0	
E94ZF12T4A2	E94_090T4N	145.3	200.7	12.0	



The E94ZB series of dynamic braking resistors can be used to keep the bus voltage rise below the shutdown level of the over voltage protection. Bus voltage rise may happen when a rotating load is decelerated or a load is descending vertically. In this situation, the mechanical energy stored in the load is converted back to electrical energy in the motor. This process is called regeneration.

Dynamic Braking Resistors:

Resistor Model	R, Ohm	Rated Continuous Power on Heat Sink, Watts
E94ZB15A300A	15	300
E94ZB20A150A	20	150
E94ZB30A150A	30	150
E94ZB40A080A	40	80
E94ZB45A300A	45	300
E94ZB75A150A	75	150
E94ZBF0A080A	150	80

Note:

- 1.) The rated continuous power with heat sink is measured when the resistor is mounted vertically on an aluminum plate (200x200x3mm) at the room temperature 25°C. Derate the continuous power for the following conditions:

Ambient Temperature	Derate the Rated Power	
	With aluminum plate (200X200X3mm)	Without aluminum plate (i.e., Free Air)
25 °C	No derating	Derate by 20%
40 °C	Derate by 5%	Derate by 25%

- 2.) The continuous power supplied to the resistor shall not exceed the continuous power rating of the resistor.
- 3.) The surface temperature can reach up to 200°C.
- WARNING!** Do not put any flammable material close to the resistor.
- 4.) Resistors must be vertically mounted on heat sink or metal plate for adequate cooling and safe operation.

Dynamic Brake Resistor Dimensions:

Model Number	Dimensions (mm)							Weight (kg)
	L1	L2	L3	H	D1±0.3	W = a + b		
						a	b	
E94ZB15A300A	215	196	175	60	5.3	13	17	0.60
E94ZB20A150A	210	197	170	41	4.3	10	12	0.29
E94ZB30A150A	210	197	170	41	4.3	10	12	0.29
E94ZB40A080A	150	137	110	41	4.3	10	12	0.19
E94ZB45A300A	215	196	175	60	5.3	13	17	0.60
E94ZB75A150A	210	197	170	41	4.3	10	12	0.29
E94ZBF0A080A	150	137	110	41	4.3	10	12	0.19

*The length of the flying leads is 0.5 meters.

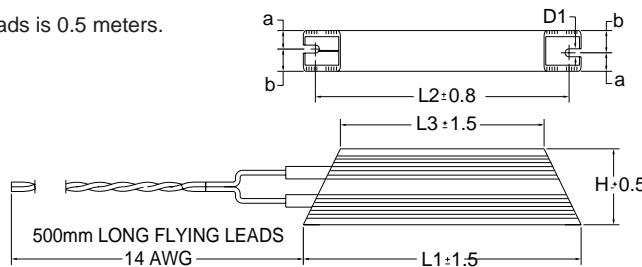

PositionServo Drive Compatibility Between Resistors

Compatible Drive Models	Resistor Model
E94_020S1N, E94_040S1N E94_020S2F, E94_040S2F E94_020Y2N, E94_040Y2N	E94ZB40A080A
E94_120Y2N	E94ZB30A150A
E94_080S2F, E94_100S2F E94_080Y2N, E94_100Y2N	E94ZB20A150A
E94_020T4N	E94ZBF0A080A
E94_040T4N, E94_050T4N, E94_060T4N	E94ZB75A150A
E94_090T4N	E94ZB45A300A
E94_180T2N	E94ZB15A300A

ISO13849-1 Safety Circuit

PositionServo drives with suffixes “ES” and “RS” include a safety circuit that allows the drive output to the motor to be disabled so that the drive cannot generate torque in the motor. This safety function, termed “Safe Standstill”, meets the requirements of ISO13849-1 (previously EN954-1 Safety of Machinery – Safety-related Parts of Control Systems.)

This function provides a highly reliable disable function of the drive where no single component failure will cause the drive to enable and complies with the ISO13849-1 safety standard.

ISO13849-1: the five categories for safety-related parts of control systems

- Category B**
 The basic category. The occurrence of a fault can lead to loss of safety function;
- Category 1**
 Improved resistance to faults is achieved predominantly by selection and application of components. This is achieved by using well-tried components and well-tried safety principles.
- Category 2**
 Improved performance is required. This is achieved by using all the principles stated in Category 1 together with designing the control system so that the safety-related functions are checked at suitable intervals by the machine control system. This check will be made at machine start-up and at other periods as determined by the risk assessment. After detection of a fault, a safe state will be maintained until the fault has been cleared.
- Category 3**
 A single fault will not lead to loss of a safety function. This requires the application of all the principles of previously mentioned categories B, 1, and 2 together with the safety-related parts of the control system being designed so that a single fault in any of these parts does not lead to a loss of the safety function.
- Category 4**
 All faults will be detected and there is protection against an accumulation of faults that needs to be specified. The safety-related parts of the control need to be designed so the a single fault does not lead to a loss of safety function and the single fault will be detected at or before the next demand for the safety function.

This option is located at the base of the PositionServo drive and must be configured at the factory prior to shipment.

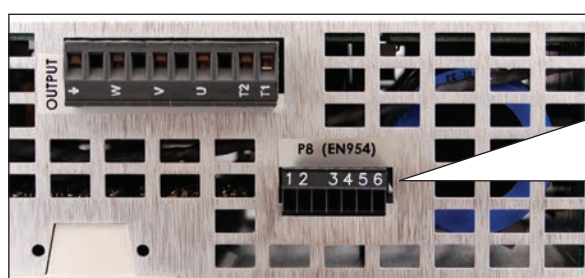

P8 PIN ASSIGNMENTS (SAFETY FUNCTION)

Pin	Name	Function
1	Bypass Voltage	ISO13849-1 Bypass Voltage (+24VDC)
2	Bypass COM	ISO13849-1 Bypass Common
3	Safety Status	ISO13849-1 Safety Status
4	Safety Input1	ISO13849-1 Safety Input 1 (+24VDC to Enable)
5	Safety COM	ISO13849-1 Safety Common
6	Safety Input2	ISO13849-1 Safety Input 2 (+24VDC to Enable)

Putting your system together is now simple. The following pages give details and specifications for all of the PositionServo and motor system cables. Refer to the tables below as a quick reference guide.

Motor System Cables

Motor Family	Motor Power Cables	Encoder Cables	Resolver Cables
MCS	EWLB___FE_NA	EWLE___AE1NA	EWLR___BE1NA

Additional System Cables

Cable	Description
EWLN002SF1NA	2 meter I/O Expansion Cable

Cable Model Number Designation Code

	EWL	M	005	F	D	1NA
Electrical Cable						
Cable Configuration: M = Power Cable for Servo Motor B = Power Cable for Servo Motor with Mechanical Brake E = Control Cable for Encoder Feedback R = Control Cable for Resolver Feedback N = Control: I/O Expansion Cable						
Cable Length [meters]: 002 = 2.5 meters 005 = 5 meters 010 = 10 meters						
Connector Type [Drive End]: A = DB-15 [M] B = DB-9 [M] C = DB-9 [F] F = Flying Leads S = SCSI (50-pin)						
Connector Type [Feedback/Motor End]: B = DB-15 [F] C = CPC Connector D = IP65 M17 Plug [F] E = IP65 M23 Plug [F] F = Flying leads						
Variations/Cable Construction: 1NA = 1st Variation/Normal Construction 2NA = 2nd Variation/Normal Construction						



Power Cables – M23 Connector [Motor] to flying leads [Drive]

Model #	Specifications	Length
EWLB002FE1NA:	1.5 mm ² /16 AWG power cable, <= 12 amps drive output current	*L = 2.5 meters
EWLB005FE1NA:	1.5 mm ² /16 AWG power cable, <= 12 amps drive output current	*L = 5.0 meters
EWLB010FE1NA:	1.5 mm ² /16 AWG power cable, <= 12 amps drive output current	*L = 10.0 meters

*Length includes brake leads. These cables can be used for both brake and non-brake motors.

Dimensions are in millimeters.

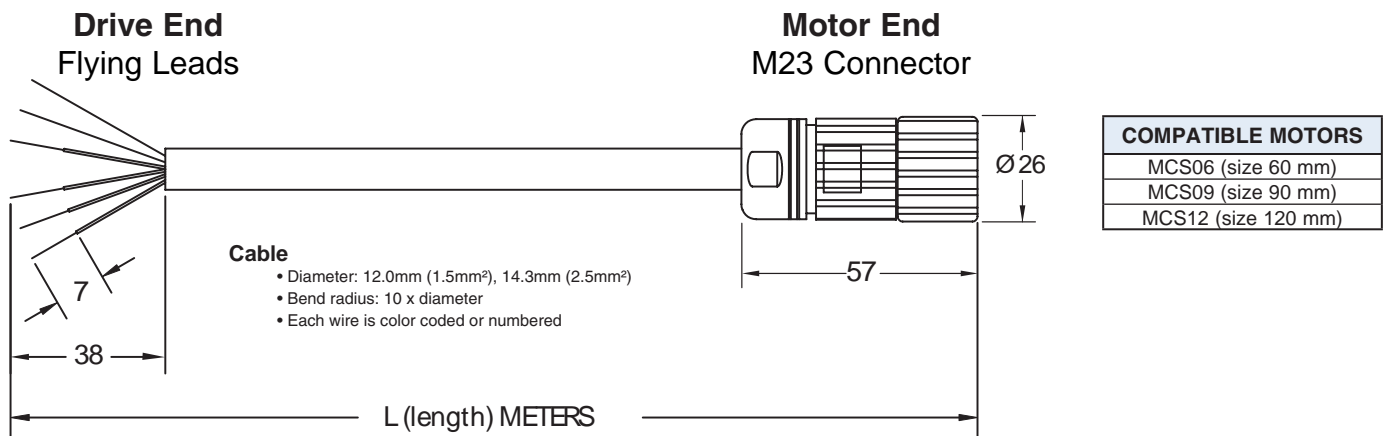

Flying Leads - wiring to PositionServo Drive

M23 Connector

401-231 Intercontec #BSTA107FR03580036000

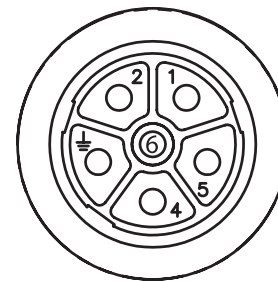
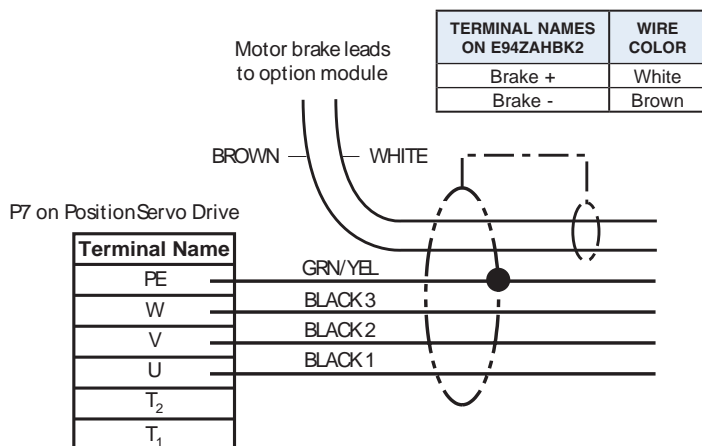

PIN	WIRE COLOR/NUMBER	TERMINAL NAME
1	WHITE	MOTOR BRAKE +
2	BROWN	MOTOR BRAKE -
3	GRN/YEL	PE
4	BLACK 1	U (R)
5	BLACK 2	V (S)
6	BLACK 3	W (T)



WARNING:

Do not connect U, V, W wires to PTC Input! Severe damage to the drive will result.



Power Cables – M23 Connector [Motor] to flying leads [Drive]

Model #	Specifications	Length
EWLB002FE2NA:	2.5 mm ² /14 AWG power cable, <= 17.4 amps drive output current	*L = 2.5 meters
EWLB005FE2NA:	2.5 mm ² /14 AWG power cable, <= 17.4 amps drive output current	*L = 5.0 meters
EWLB010FE2NA:	2.5 mm ² /14 AWG power cable, <= 17.4 amps drive output current	*L = 10.0 meters

*Length includes brake leads. These cables can be used for both brake and non-brake motors.

Dimensions are in millimeters.

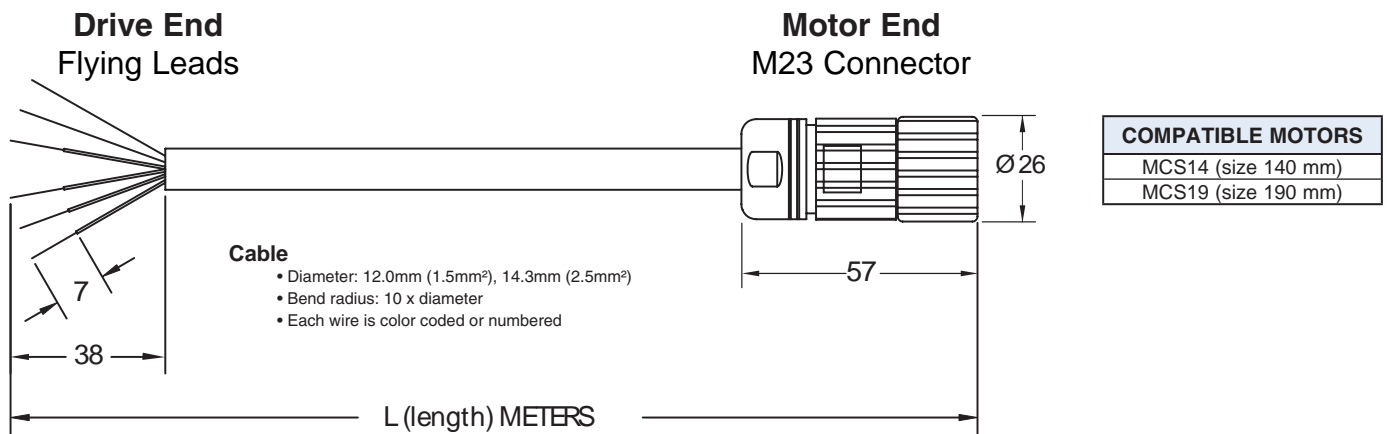

Flying Leads - wiring to PositionServo Drive

M23 Connector

401-231 Intercontec #BSTA107FR03580036000

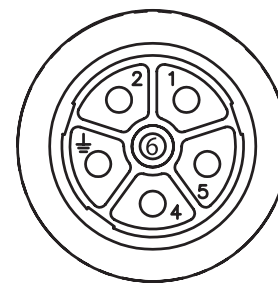
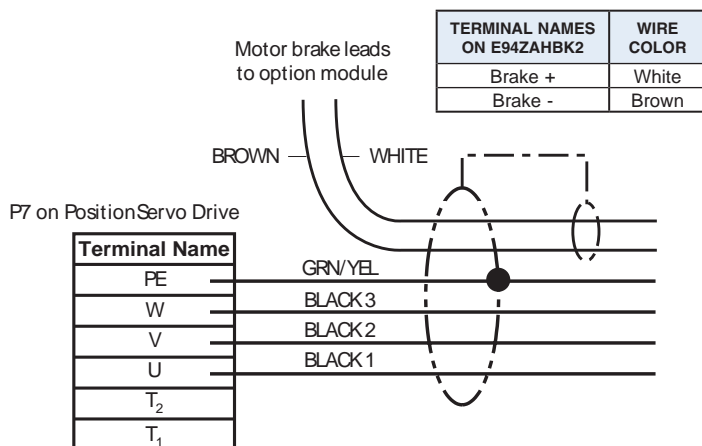

PIN	WIRE COLOR/NUMBER	TERMINAL NAME
1	WHITE	MOTOR BRAKE +
2	BROWN	MOTOR BRAKE -
3	GRN/YEL	PE
4	BLACK 1	U (R)
5	BLACK 2	V (S)
6	BLACK 3	W (T)



WARNING:

Do not connect U, V, W wires to PTC Input! Severe damage to the drive will result.

Encoder Cables – M23 [Motor] and DB-15 [Drive] connectors

Model #	Specifications	Length
EWLE002AE1NA:	DB-15 [M] connector on drive end, M23 connector on motor end	L = 2.5 meters
EWLE005AE1NA:	DB-15 [M] connector on drive end, M23 connector on motor end	L = 5.0 meters
EWLE010AE1NA:	DB-15 [M] connector on drive end, M23 connector on motor end	L = 10.0 meters

Drive End DB-15 [M] Connector

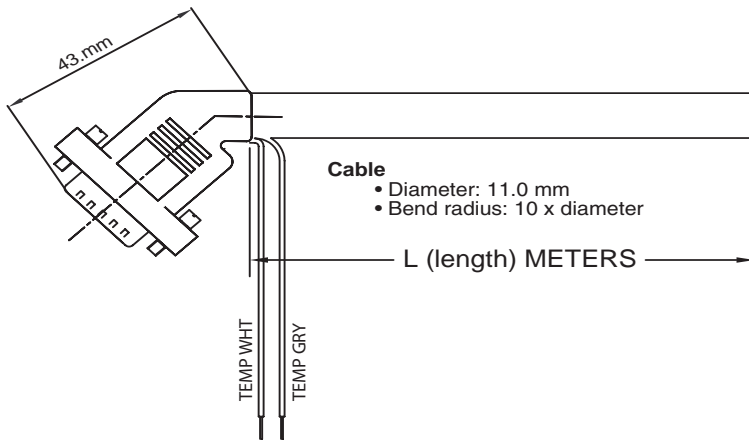

Motor End M23 Connector

COMPATIBLE MOTORS
All MCS Encoder Motors (MCS_ _ _ _ _ C40)

DB-15 [M] Connector Dimensions

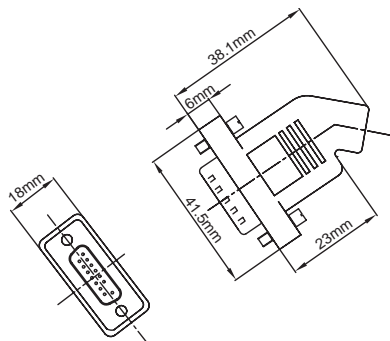

M23 Connector

401-224 Intercontec # ASTA035FR01610035000, Qty. 1

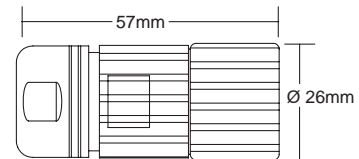

Pin Outs

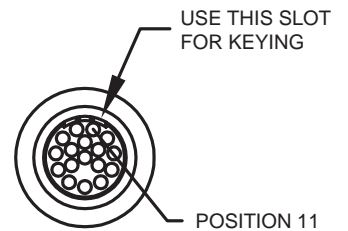
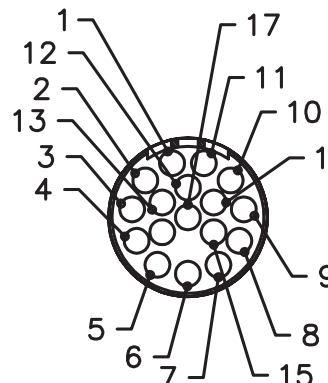
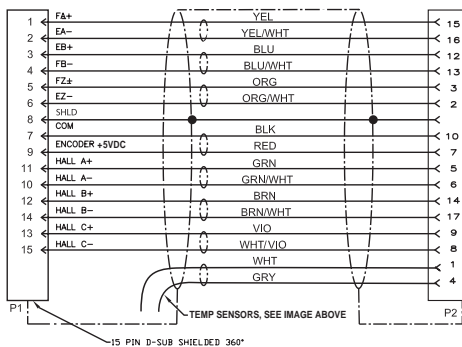
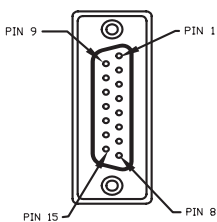

Resolver Cable - M23 [Motor] and DB-9 [Drive] Connectors

Model #	Specifications	Length
EWLR002BE1NA:	DB-9 [M] connector on drive end, M23 connector on motor end	L = 2.5 meters
EWLR005BE1NA:	DB-9 [M] connector on drive end, M23 connector on motor end	L = 5.0 meters
EWLR010BE1NA:	DB-9 [M] connector on drive end, M23 connector on motor end	L = 10.0 meters

Drive End
DB-9 [M] Connector

Motor End
M23 Connector

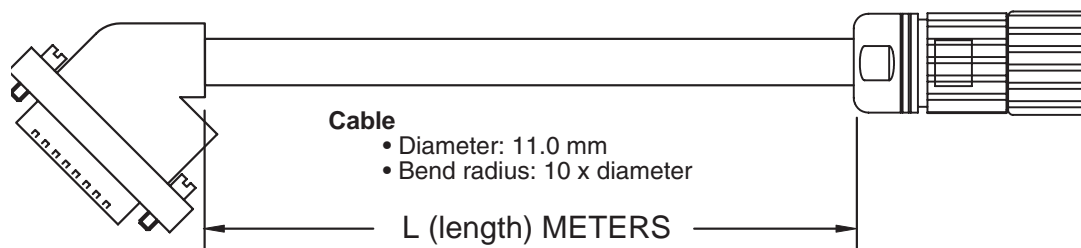

COMPATIBLE MOTORS
All MCS Resolver Motors (MCS_____RM0M)

Connector Dimensions

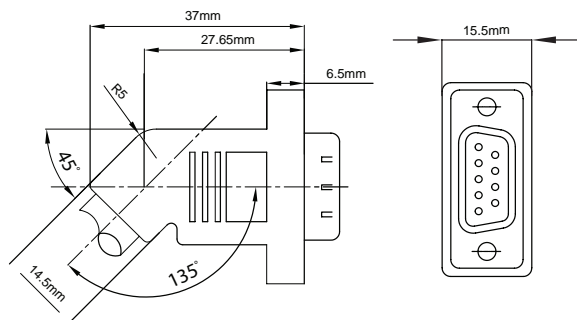

M23 Connector

401-238 Intercontec # ASTA021FR01610035000, Qty. 1

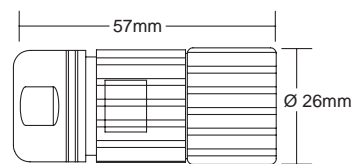

Pin Outs

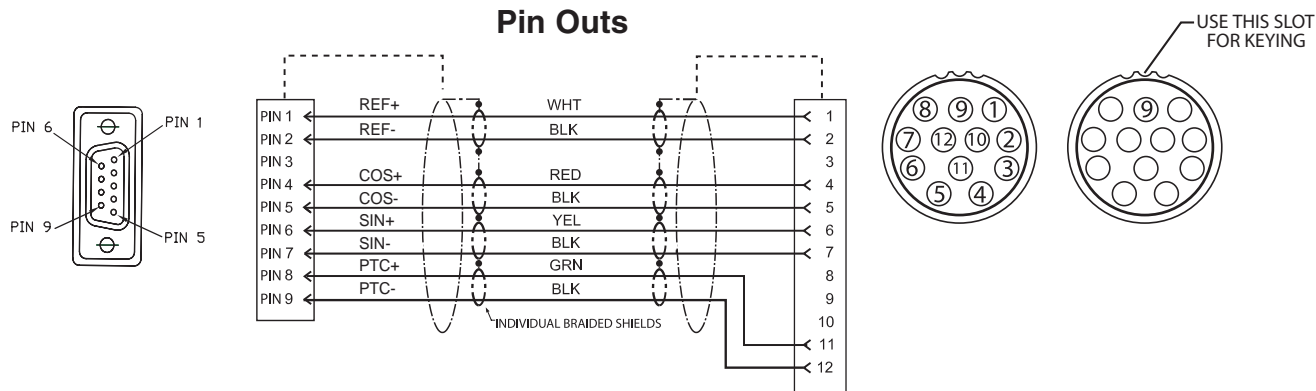

I/O Expansion Cable

Model #	Specifications	Length
EWLN002SF1NA:	50-pin SCSI [M] on drive end to flying leads	L = 2.0 meters
EWLN002SF2NA:	50-pin SCSI [M] on drive end to flying leads	L = 2.0 meters

Drive End
SCSI (50 pin) [M] Connector

Flying Leads

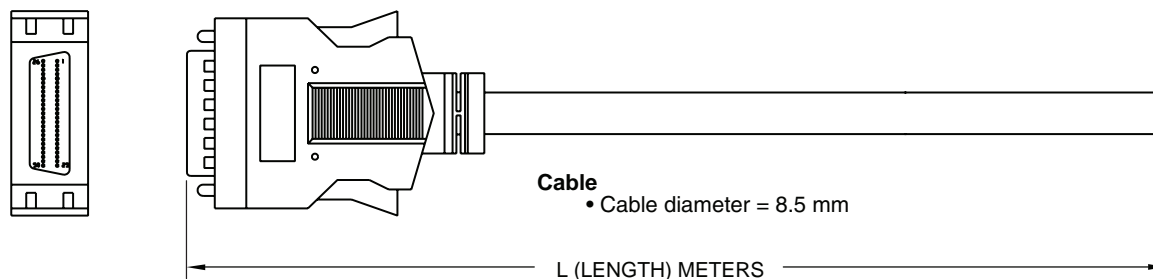

P3 Pin Assignments (Controller Interface)

Pin	Name	Function	SF1NA Color	SF2NA Color
1	MA+	Master Encoder A+ / Step+ input ⁽²⁾	Yellow	Black
2	MA-	Master Encoder A- / Step- input ⁽²⁾	Yellow / Black	Black / White
3	MB+	Master Encoder B+ / Direction+ input ⁽²⁾	Red	Brown
4	MB-	Master Encoder B- / Direction- input ⁽²⁾	Red / Black	Brown / White
5	GND	Drive Logic Common	Brown	Red
6	5+	+5V output (max 100mA)	Brown / White	Red / Black
7	BA+	Buffered Encoder Output: Channel A+ ⁽¹⁾	Light Blue	Orange
8	BA-	Buffered Encoder Output: Channel A- ⁽¹⁾	Light Blue / Black	Orange / Black
9	BB+	Buffered Encoder Output: Channel B+ ⁽¹⁾	Light Blue / Green	Yellow
10	BB-	Buffered Encoder Output: Channel B- ⁽¹⁾	Light Blue / Yellow	Yellow / Black
11	BZ+	Buffered Encoder Output: Channel Z+ ⁽¹⁾	Green	Green
12	BZ-	Buffered Encoder Output: Channel Z- ⁽¹⁾	Green / Black	Green / Black
13-19		Empty		
20	AIN2+	Positive (+) of Analog signal input	Grey / Green	Grey / Red
21	AIN2-	Negative (-) of Analog signal input	Grey / Yellow	Grey / Blue
22	ACOM	Analog common	White / Yellow	Grey / Yellow
23	AO	Analog output (max 10 mA)	White / Green	Grey / Green
24	AIN1+	Positive (+) of Analog signal input	Light Green / Red	White / Red
25	AIN1 -	Negative (-) of Analog signal input	Green / Blue	White / Blue
26	IN_A_COM	Digital input group ACOM terminal ⁽³⁾	Light Blue / Blue	White / Yellow
27	IN_A1	Digital input A1	Light Blue / Red	White / Green
28	IN_A2	Digital input A2	Pink / Red	Pink / Yellow
29	IN_A3	Digital input A3 ⁽³⁾	Pink / Blue	Pink / Green
30	IN_A4	Digital input A4	Blue / White	Blue / White
31	IN_B_COM	Digital input group BCOM terminal	Grey / Red	Light Green / Red
32	IN_B1	Digital input B1	Grey / Blue	Light Green / Blue
33	IN_B2	Digital input B2	White / Black	Violet / White
34	IN_B3	Digital input B3	Pink / Black	Grey / Black
35	IN_B4	Digital input B4	Violet / White	White / Black
36	IN_C_COM	Digital input group CCOM terminal	Green / White	Light Blue / Yellow
37	IN_C1	Digital input C1	Light Green / Blue	Light Blue / Blue
38	IN_C2	Digital input C2	Grey / Black	Pink / Black
39	IN_C3	Digital input C3	Orange / Black	Light Green / Black
40	IN_C4	Digital input C4	Pink / Yellow	Light Blue / Black
41	RDY+	Ready output Collector	Yellow / Red	Light Blue / Red
42	RDY-	Ready output Emitter	Yellow / Blue	Light Blue / Green
43	OUT1-C	Programmable output #1 Collector	Red / White	Orange / Red
44	OUT1-E	Programmable output #1 Emitter	Red / Blue	Yellow / Red
45	OUT2-C	Programmable output #2 Collector	White / Red	Light Yellow / Red
46	OUT2-E	Programmable output #2 Emitter	White / Blue	Light Yellow / Black
47	OUT3-C	Programmable output #3 Collector	Light Green	Light Yellow
48	OUT3-E	Programmable output #3 Emitter	Light Green / Black	Yellow / Green
49	OUT4-C	Programmable output #4 Collector	Light Green / Yellow	White / Brown
50	OUT4-E	Programmable output #4 Emitter	Light Green / Green	White / Orange
		SCSI Connector Case (shield)	Black	



Servo Drives								
Item Number	Nominal Input Voltage	Phase	Output Current [IN]	Output Current [IMAX]	EMC Filter	Test Motor	Lead Length [m]	EN61800-3:2004 Compliance Category
E94_020S2F__	200/240V	1	2	6	Integral	MCS06C41L	2.5 5 10	C2, C3
E94_040S2F__	200/240V	1	4	12	Integral	MCS06F40L	2.5 5 10	C2, C3
E94_080S2F__	200/240V	1	8	24	Integral	MCS09F60L	2.5 5 10	C2, C3
E94_100S2F__	200/240V	1	10	30	Integral	MCS12L20L	2.5 5 10	C2, C3
E94_020Y2N__	200/240V	3	2	6	E94ZF04T4A1	MCS06C41L	2.5 5 10	C2, C3
E94_040Y2N__	200/240V	3	4	12	E94ZF07T4A1	MCS06F60L	2.5 5 10	C2, C3
E94_080Y2N__	200/240V	3	8	24	E94ZF15T4A1	MCS09F60L	2.5 5 10	C2, C3
E94_120Y2N__	200/240V	1	12	36	E94ZF24S2A1	MCS12L20L	2.5 5 10	C2, C3
E94_020T4N__	400/480V	3	2	6	E94ZF04T4A1	MCS06F41-	2.5 5 10	C2, C3
E94_040T4N__	400/480V	3	4	12	E94ZF07T4A1	MCS09F60-	2.5 5 10	C2, C3
E94_060T4N__	400/480V	3	6	18	E94ZF10T4A1	MCS12L20-	2.5 5 10	C2, C3
E94_090T4N__	400/480V	3	9	27	E94ZF12T4A2	MCS12L20-	2.5 5 10	C2, C3

NOTES:

1. Carrier frequency set at 8 and 16 kHz during compliance testing.
2. Please refer to PositionServo Users Manual for proper EMC installation guidelines.
3. Consult factory for lead lengths above 10 meters.
4. Consult factory for C1 compliance.



EMC Emission Standards: Comparison Table			
Comparable Levels of Emission Limits	EN61800-3:2004	EN61800-3/A11:2000	EN55011
	Category: C1	1 st Environment Unrestricted Distribution	Group 1 Class B
	Category: C2	1 st Environment Restricted Distribution	Group 1 Class A
	Category: C3	2 nd Environment Unrestricted Distribution	Group 2 Class A
	Category: C4	2 nd Environment Restricted Distribution	Not Applicable

DEFINITIONS:

- **EMC:** Electromagnetic Compatibility: referring to:

Emissions limits: Prescribed limits of radiated and line-conducted Emissions of various frequencies.

Immunity requirements: Levels of disturbances, at or below which, equipment must continue to operate.

- **EN 61800-3: 2004** - The standard for EMC requirements for adjustable speed electrical Power Drive Systems (PDS). A **PDS** installation includes a Drive, feeders, auxiliaries and motor, but not driven equipment. This standard applies to a drive system. Other equipment that contains a drive and is covered by product-specific standard must also meet the product standard.

First Environment: A domestic premises or an area where the AC power supply system also supplies buildings used for domestic purposes. (e.g. commercial premises in a residential building.)

Second Environment: Any environment where the AC power supply system has no connection to domestic premises.

Category C1: A PDS with rated voltage of less than 1000 volts and intended for use in the First Environment (domestic connection).

Category C2: A PDS which is neither plug-in, nor movable, nor with rated voltage over 1000 volts, and which, if installed in the First Environment, is intended to be installed and commissioned by a person or organization skilled in power drive systems including EMC aspects.

Category C3: A PDS with rated voltage of less than 1000 volts and intended for use in the Second Environment but not the First Environment.

Category C4: A PDS with rated voltage over 1000 volts or 400 Amps, or intended for complex systems (e.g. IT supply) in the Second Environment.

- **EN 61800-3/A11: 2000** - Superseded by EN 61800-3:2004.

- **EN55011** - Standard for Emissions Limits for Industrial, Scientific and Medical equipment (ISM). This is often known as base or family emissions standard, used where other specific standards do not apply. Here equipment is classified into two Groups, defined below. Each of these Groups has two Classes which correspond to the “Environment” terms defined above. These four Group-Class categories define limits of conducted and radiated emissions. Groups and Classes are as follows:

Group 1: Equipment in which RF energy is generated or used in otherwise providing the function of the equipment.

Group 2: Equipment in which RF energy is generated and/or used in the form of electromagnetic radiation for treatment of a material.

Class B: Same meaning as First Environment definition above (domestic connection).

Class A: Same meaning as Second Environment definition above.

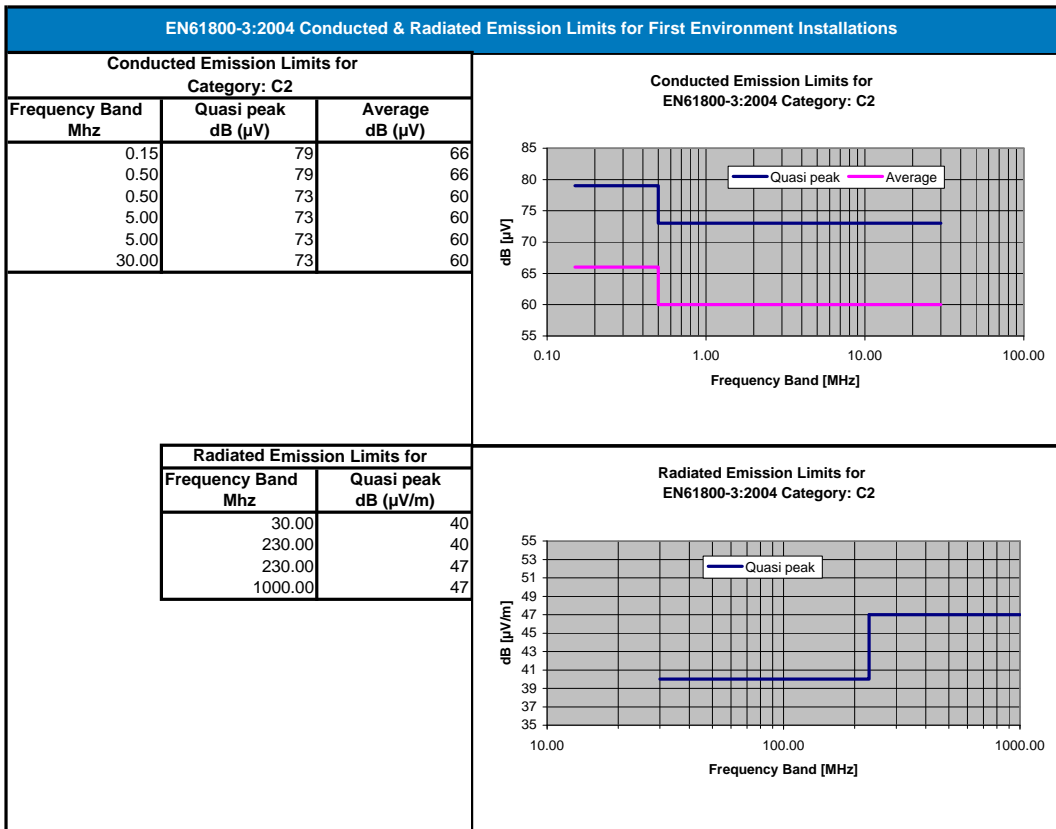
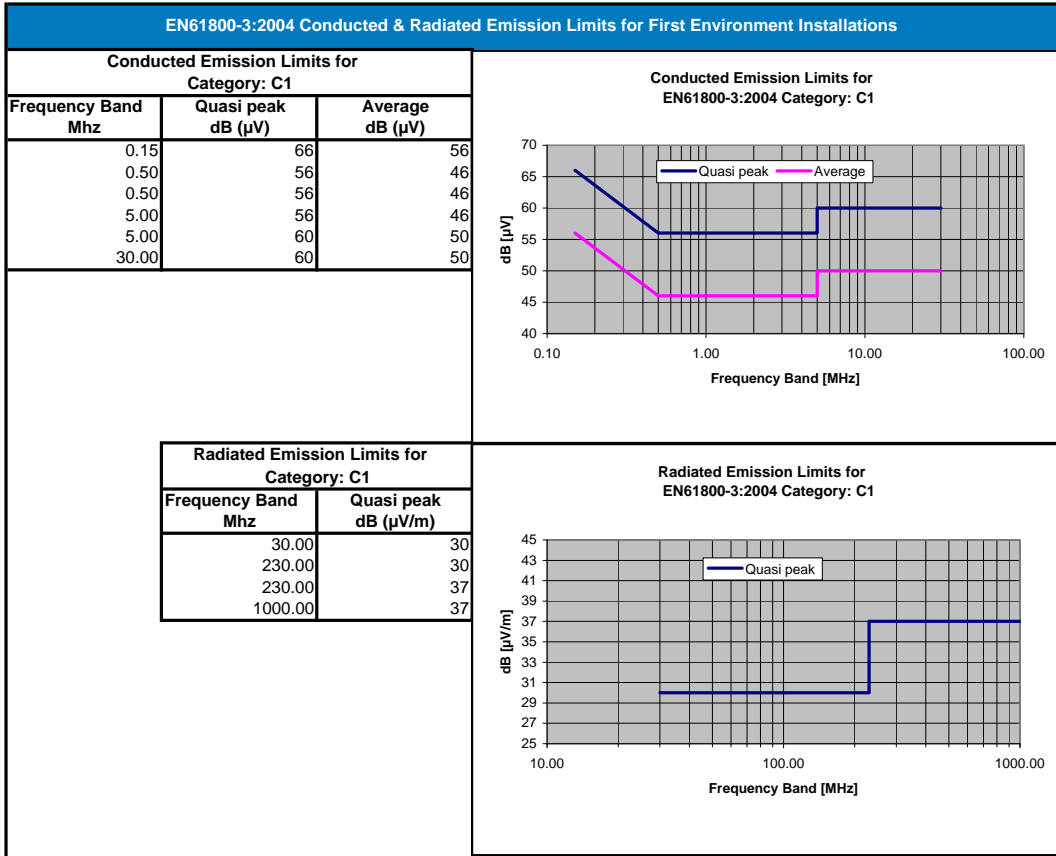

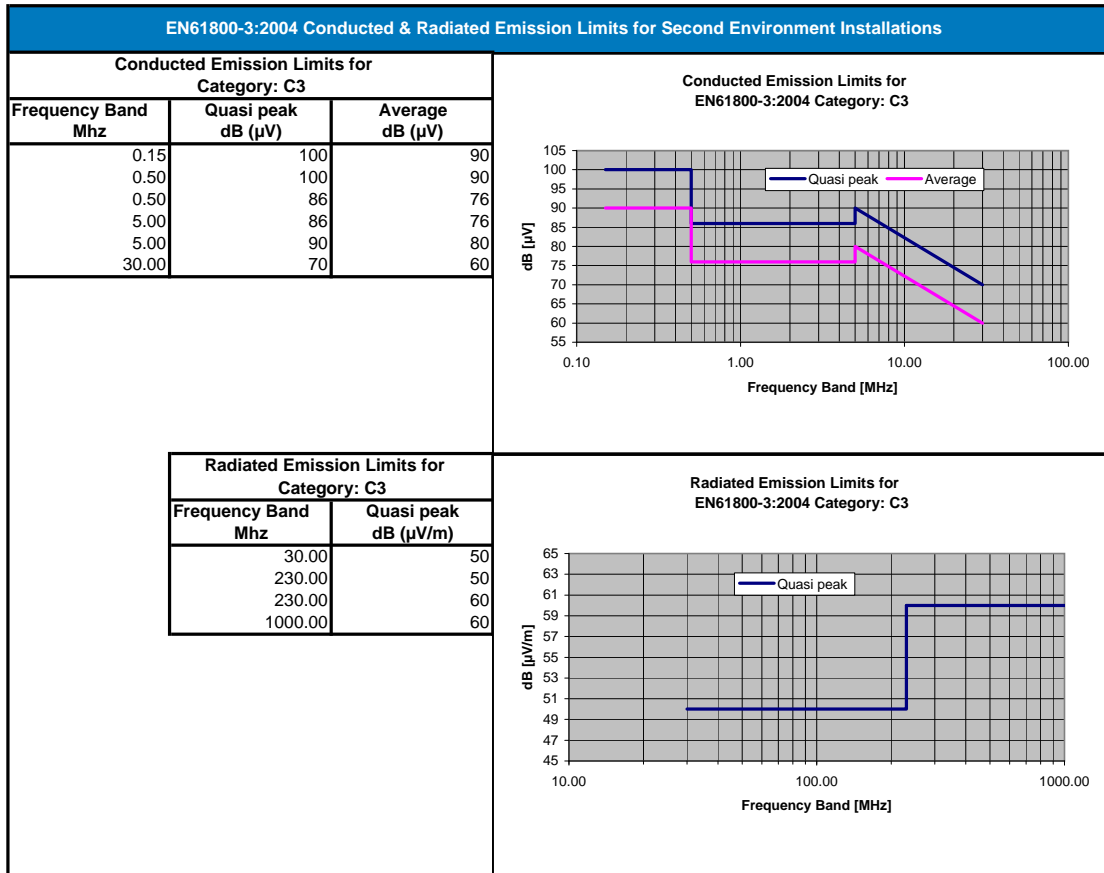

**The best machines and production facilities
around the world use Lenze.**



Positioning our Customers for Success. We take our Customer's requirements seriously. A new application is an opportunity to test, prove and expand our drive's capabilities while solving our Customer's motion control needs.



Customer Service has always been and will always be our number one commitment. Our success depends on it.



Driving design technology forward means we never stop thinking about process improvements. Did we deliver a quality product to market that meets the Customer's needs? That is the key.



Innovation takes art and skill to combine what's new and what's proven to produce a product with exceptional form, fit and function.

Lenze

www.lenzeamericas.com

1-800-217-9100

1-508-278-9100

+44 (0) 1743 464309