

# New solutions for the food industry



The SKF brand now stands for more than ever before, and means more to you as a valued customer.

While SKF maintains its leadership as the hallmark of quality bearings throughout the world, new dimensions in technical advances, product support and services have evolved SKF into a truly solutions-oriented supplier, creating greater value for customers.

These solutions encompass ways to bring greater productivity to customers, not only with breakthrough application-specific products, but also through leading-edge design simulation tools and consultancy services, plant asset efficiency maintenance programs, and the industry's most advanced supply management techniques.

The SKF brand still stands for the very best in rolling bearings, but it now stands for much more.

**SKF - the knowledge engineering company.**

# The food industry has a new ally

Stop corrosion from eating away at your bottom line - with food grade housing units from SKF. Whether you are in the food or beverage processing, or in the pharmaceutical industry, corrosion is very often a problem. Corrosion can contaminate your product, harbour bacteria and erode the bottom line. But now there's a cost-effective solution to this corrosion problem. It's the new food-grade bearing unit with composite housing from SKF.

The food and beverage processing industries have unique requirements. In some cases the product is acidic - as is the case for citrus processors. In other cases, the product is abrasive (biscuits and similar bakery products as example). In either cases, machinery is exposed to frequent high-pressure wash downs with caustic anti-bacterial cleansing agents.

These frequent wash downs add water and cleaning solutions to the list of contaminants that cause rust and accelerate bearing failure. To virtually eliminate the problems of corrosion and premature bearing damage caused by frequent wash downs, SKF has developed a complete assortment of bearings and bearing units for the food and beverage processing industries.

The bearings and bearing housings have been specifically designed for fast, easy wash downs. The housing's non-porous surface resists the accumulation of bacteria forming food particles, and the light grey colour of the housing makes visual inspection easy.



# Stainless steel or coated bearings, the choice is yours

In some applications, there is no choice, stainless steel bearings are the only option. In other applications, however, you have a choice between stainless steel bearings or the new SKF coated bearings. These bearings are equipped with a low friction multi-lip rubber seal that is bonded to a stainless steel core. The SKF multi-functional seal, which was first designed for agricultural applications, provides superior protection against wash downs and solid contaminants.

## Maintenance free and self-aligning

Whether you choose a stainless steel bearing or a coated bearing, each one is maintenance free and designed to be self-aligning to provide longer bearing service life. To accommodate misalignment, the concave bore of the housing is designed to accommodate the convex outside diameter of the bearing. This arrangement minimizes internal loads acting on the bearings that could be the result of installation errors. Maintenance-free means “fit and forget”.

No more under-greasing or over-greasing the bearing. Each bearing is filled with an FDA approved food quality grease that will adequately lubricate the bearing under normal operating conditions.

- A) Insert bearing is pre-lubricated with an FDA approved grease
- B) Low friction multi-lip seal, bonded to a stainless steel core
- C) Food compatible rubber
- D) Additional grease filling for better sealing performances
- E) Stainless steel balls (100Cr6 for coated)
- F) Convex outside diameter accommodates misalignment



# High performance seal provides longer bearing service life

The seal used on the SKF food grade bearing units with composite housing was originally developed for agricultural applications where water, mud and dirt are considered normal operating conditions. This high performance sealing arrangement consists of a multi-lip seal, supported by a stainless steel insert, a stainless steel flinger, and a food-compatible rubber backed seal gasket.

The flinger and seal's low-friction rubber lips with optimised axial contact, form a double barrier against contaminants and wash downs. The seal gasket prevents contaminants from migrating around the seal insert's outside diameter. The flinger adds mechanical and centrifugal protection to prevent contaminants from entering into the bearing cavity. The space between the insert seal and flinger is filled with an SKF food grade grease for even greater sealing efficiency.

## SKF food grade grease resists washout

The SKF food grade bearing unit with composite housing is pre-lubricated for life with an SKF food grade grease. This high quality synthetic grease is odourless and tasteless, leaving foodstuffs unaffected. It resists washout even during frequent wash downs with hot or cold water with disinfectant solutions. This grease can be used in applications where operating temperatures range from  $-45$  to  $+120$  °C ( $-49$  to  $+248$  °F). SKF food grade grease is approved for use in all meat, fish, poultry and fruit processing equipment. Nevertheless, for extreme applications where experience shows the need, the unit can be re-greased.

The whole range of bearing units is provided with a stainless steel re-lubrication system.

## The product line

The product line comprises two complementary designs (L design and KC design), in several housing shapes. This extensive range is completed with open and closed end covers, available as accessories. The whole program is made easily accessible through SKF's global distribution network.



# L design

- specifically designed for the food industry
- boundary dimensions conform to international standards
- housings made of glass fibre reinforced polyester
- machined spherical seats
- SKF light-grey colour facilitates visual inspections
- smoothed shapes to achieve highest respect of safety and hygienic trends
- stainless steel grease nipple fitted in a moulded stainless steel bushing
- one-piece stainless steel bolt hole bushings
- solid base
- open or closed light-grey end cover
- double side cover seat available on pillow blocks
- five housing shapes available



# KC design

- conceived for “clean” applications
- boundary dimensions conform to international standards
- housings made of glass fibre reinforced polyamide
- incorporating a steel coil to provide high dimensional stability
- SKF light-grey colour facilitates visual inspections
- light weight
- stainless steel grease nipple
- stainless steel bolt hole bushing
- flat base
- black end covers
- optimized resistance to shock loads, vibrations
- centring diameter on flanged housings



# Stainless steel bearings

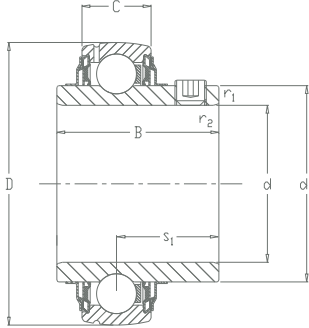

## YAR ...-2RF/HV



Bearing designation	d		d <sub>1</sub>	D	B	C	s <sub>1</sub>	r <sub>1,2 min</sub>	C	C <sub>0</sub>	Mass
	mm	inch									
YAR 204-012-2RF/HV	19,05	3/4	28,2	47	31	14	18,3	0,6	10,8	6,55	0,142
YAR 204-2RF/HV	20		28,2	47	31	14	18,3	0,6	10,8	6,55	0,135
YAR 205-2RF/HV	25		33,7	52	34,1	15	19,8	0,6	11,9	7,8	0,172
YAR 205-100-2RF/HV	25,4	1	33,7	52	34,1	15	19,8	0,6	11,9	7,8	0,168
YAR 206-2RF/HV	30		39,7	62	38,1	18	22,2	0,6	16,3	11,2	0,276
YAR 206-103-2RF/HV	30,162	1.3/16	39,7	62	38,1	18	22,2	0,6	16,3	11,2	0,274
YAR 207-104-2RF/HV	31,75	1.1/4	46,1	72	42,9	19	25,4	1	21,6	15,3	0,462
YAR 207-106-2RF/HV	34,925	1.3/8	46,1	72	42,9	19	25,4	1	21,6	15,3	0,406
YAR 207-2RF/HV	35		46,1	72	42,9	19	25,4	1	21,6	15,3	0,405
YAR 207-107-2RF/HV	36,512	1.7/16	46,1	72	42,9	19	25,4	1	21,6	15,3	0,376
YAR 208-108-2RF/HV	38,1	1.1/2	51,8	80	49,2	21	30,2	1	24,7	19	0,593
YAR 208-2RF/HV	40		51,8	80	49,2	21	30,2	1	24,7	19	0,548

2RF Sealing systems:  
Supergriseal + rubberized Flinger

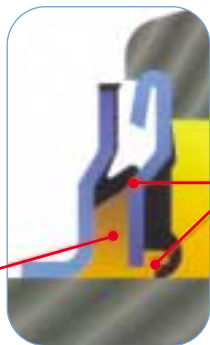

Grease for additional sealing effect

Low friction rubber lips to form a double barrier against contaminants

<b>Rings</b>	AISI 420 B
<b>Balls</b>	AISI 420
<b>Screws</b>	AISI 304 (from size 204 to size 207) AISI 420 (size 208)
<b>Seals, flingers</b>	AISI 304 + NBR
<b>Cage</b>	Fibre glass reinforced polyamide
<b>Grease</b>	Food Industry approved USDA H1



# Zinc-coated bearings

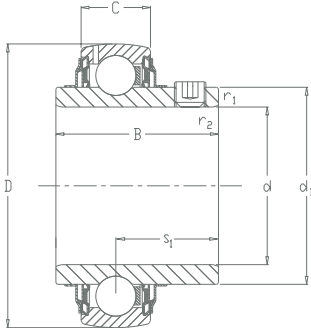

**YAR ...-2RF/VE495**



Bearing designation	d		d <sub>1</sub>	D	B	C	s <sub>1</sub>	r <sub>1,2 min</sub>	C	C <sub>0</sub>	Mass
	mm	inch									
YAR 204-2RF/VE495	20		28,20	47	31	14	18,3	0,6	12,7	6,55	0,135
YAR 205-2RF/VE495	25		33,74	52	34,1	15	19,8	0,6	14	7,8	0,172
YAR 206-2RF/VE495	30		39,70	62	38,1	18	22,2	0,6	19,5	11,2	0,276
YAR 207-2RF/VE495	35		46,10	72	42,9	19	25,4	1	25,5	15,3	0,405
YAR 208-2RF/VE495	40		51,80	80	49,2	21	30,2	1	30,7	19	0,548

2RF Sealing systems:  
Supergriseal + rubberized Flinger

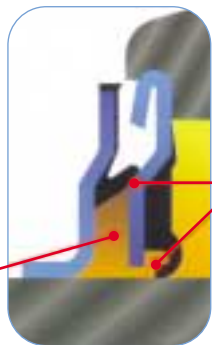

Grease for additional sealing effect

Low friction rubber lips to form a double barrier against contaminants

<b>Rings</b>	100Cr6, Zinc-coated
<b>Balls</b>	100Cr6
<b>Screws</b>	AISI 304 (from size 204 to size 207) AISI 420 (size 208)
<b>Seals, flingers</b>	AISI 304 + NBR
<b>Cage</b>	Fibre glass reinforced polyamide
<b>Grease</b>	Food Industry approved USDA H1

# Plummer block unit with composite housing

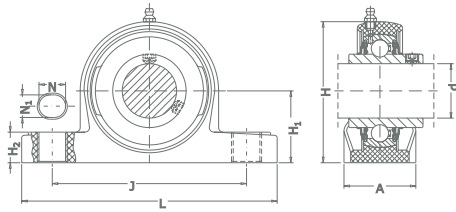

**SYL housing**  
(with stainless steel bearing)



Unit designation	d		A	H	H <sub>1</sub>	H <sub>2</sub>	J	L	N	N <sub>1</sub>	Bolt size	Bearing designation
	mm	inch										
SYL 3/4 TH		3/4	38	65,5	33,3	14,2	95	127	14	11	M10	YAR 204-012-2RF/HV
SYL 20 TH	20		38	65,5	33,3	14,2	95	127	14	11	M10	YAR 204-2RF/HV
SYL 25 TH	25		38	71	36,5	14,5	105	140	14	11	M10	YAR 205-2RF/HV
SYL 1. TH		1	38	71	36,5	14,5	105	140	14	11	M10	YAR 205-100-2RF/HV
SYL 30 TH	30		46	83	42,9	17,8	119	163	18	14	M12	YAR 206-2RF/HV
SYL 1.1/4 TH		1.1/4	48	94	47,6	18	127	167	18	14	M12	YAR 207-104-2RF/HV
SYL 35 TH	35		48	94	47,6	18	127	167	18	14	M12	YAR 207-2RF/HV
SYL 1.1/2 TH		1.1/2	54	98	49,2	19,5	137	184	18	14	M12	YAR 208-108-2RF/HV
SYL 40 TH	40		54	98	49,2	19,5	137	184	18	14	M12	YAR 208-2RF/HV

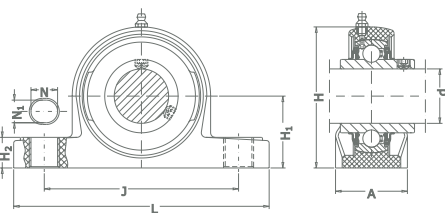

**SYL housing**  
(with zinc-coated bearing)



Unit designation	d		A	H	H <sub>1</sub>	H <sub>2</sub>	J	L	N	N <sub>1</sub>	Bolt size	Bearing designation
	mm	inch										
SYL 20 TR/VE495	20		38	65,5	33,3	14,2	95	127	14	11	M10	YAR 204-2RF/VE495
SYL 25 TR/VE495	25		38	71	36,5	14,5	105	140	14	11	M10	YAR 205-2RF/VE495
SYL 30 TR/VE495	30		46	83	42,9	17,8	119	163	18	14	M12	YAR 206-2RF/VE495
SYL 35 TR/VE495	35		48	94	47,6	18	127	167	18	14	M12	YAR 207-2RF/VE495
SYL 40 TR/VE495	40		54	98	49,2	19,5	137	184	18	14	M12	YAR 208-2RF/VE495

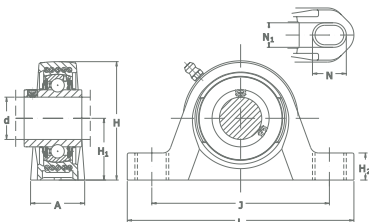

**SYKC grey Y-TECH housing**  
(with stainless steel bearing)



Unit designation	d		A	H	H <sub>1</sub>	H <sub>2</sub>	J	L	N	N <sub>1</sub>	Bolt size	Bearing designation
	mm	inch										
SYKC 20 NTH	20		32	64	33,3	16	96	126	17,5	12,5	M10	YAR 204-2RF/HV
SYKC 25 NTH	25		32	70,5	36,5	16	105	134	17,5	12,5	M10	YAR 205-2RF/HV
SYKC 30 NTH	30		40	82	42,9	19	121	159	21,5	14,5	M12	YAR 206-2RF/HV
SYKC 35 NTH	35		45	93	47,6	19	126	164	21,5	14,5	M12	YAR 207-2RF/HV
SYKC 40 NTH	40		48	99	49,2	19	136	176	21,5	14,5	M12	YAR 208-2RF/HV

# Flanged unit with composite square housing

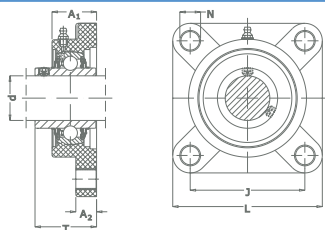

**FYL housing**  
(with stainless steel bearing)



Unit designation	d		A <sub>1</sub>	A <sub>2</sub>	J	L	N	T	Bolt size	Bearing designation
	mm	inch								
FYL 3/4 THR		3/4	27,8	13,4	63,5	86	11	36,3	M10	YAR 204-012-2RFGR/HV
FYL 20 THR	20		27,8	13,4	63,5	86	11	36,3	M10	YAR 204-2RFGR/HV
FYL 25 THR	25		28	14,3	70	95	11	36,7	M10	YAR 205-2RFGR/HV
FYL 1. THR		1	28	14,3	70	95	11	36,7	M10	YAR 205-100-2RFGR/HV
FYL 30 THR	30		31,5	14,3	83	107	11	41,4	M10	YAR 206-2RFGR/HV
FYL 1.1/4 THR		1.1/4	34,8	15,5	92	118	13	46,9	M12	YAR 207-104-2RFGR/HV
FYL 35 THR	35		34,8	15,5	92	118	13	46,9	M12	YAR 207-2RFGR/HV
FYL 1.1/2 THR		1.1/2	37,5	17	102	130	14	53,2	M12	YAR 208-108-2RFGR/HV
FYL 40 THR	40		37,5	17	102	130	14	53,2	M12	YAR 208-2RFGR/HV

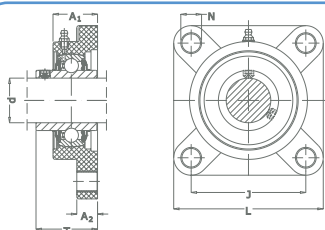

**FYL housing**  
(with zinc-coated bearing)



Unit designation	d		A <sub>1</sub>	A <sub>2</sub>	J	L	N	T	Bolt size	Bearing designation
	mm	inch								
FYL 20 TR/VE495	20		27,8	13,4	63,5	86	11	36,3	M10	YAR 204-2RF/VE495
FYL 25 TR/VE495	25		28	14,3	70	95	11	36,7	M10	YAR 205-2RF/VE495
FYL 30 TR/VE495	30		31,5	14,3	83	107	11	41,4	M10	YAR 206-2RF/VE495
FYL 35 TR/VE495	35		34,8	15,5	92	118	13	46,9	M12	YAR 207-2RF/VE495
FYL 40 TR/VE495	40		37,5	17	102	130	14	53,2	M12	YAR 208-2RF/VE495

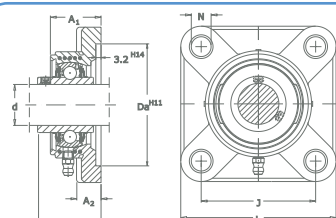

**FYKC grey Y-TECH housing**  
(with stainless steel bearing)



Unit designation	d		A <sub>1</sub>	A <sub>2</sub>	D <sub>p</sub>	J	L	N	T	Bolt size	Bearing designation
	mm	inch									
FYKC 20 NTH	20		30	15	68,3	63,5	86	12	37,3	M10	YAR 204-2RF/HV
FYKC 25 NTH	25		31	15	74,6	70	95	12	38,8	M10	YAR 205-2RF/HV
FYKC 30 NTH	30		33	15,3	93,7	82,5	108	12	42,2	M10	YAR 206-2RF/HV
FYKC 35 NTH	35		35	17	106,4	92	118	14,5	46,4	M12	YAR 207-2RF/HV
FYKC 40 NTH	40		39	17	115,9	101,5	130	14,5	54,2	M12	YAR 208-2RF/HV

# Flanged unit with composite oval housing

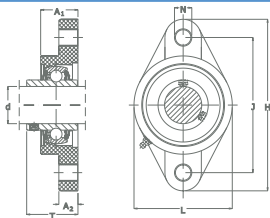

**FYTL housing**  
(with stainless steel bearing)



Unit designation	d		A <sub>1</sub>	A <sub>2</sub>	H	J	L	N	T	Bolt size	Bearing designation
	mm	inch									
FYTL 3/4 THR		3/4	26,5	11,4	113	90	65	11	33,3	M10	YAR 204-012-2RFGR/HV
FYTL 20 THR	20		26,5	11,4	113	90	65	11	33,3	M10	YAR 204-2RFGR/HV
FYTL 25 THR	25		29,1	13,5	130	99	70	11	35,8	M10	YAR 205-2RFGR/HV
FYTL 1. THR		1	29,1	13,5	130	99	70	11	35,8	M10	YAR 205-100-2RFGR/HV
FYTL 30 THR	30		30,5	13,3	148	117	80	11	40,2	M10	YAR 206-2RFGR/HV
FYTL 1.1/4 THR		1.1/4	32,8	16,1	163	130	90	13	44,4	M12	YAR 207-104-2RFGR/HV
FYTL 35 THR	35		32,8	16,1	163	130	90	13	44,4	M12	YAR 207-2RFGR/HV
FYTL 1.1/2 THR		1.1/2	37,5	20	176	144	100	14	51,2	M12	YAR 208-108-2RFGR/HV
FYTL 40 THR	40		37,5	20	176	144	100	14	51,2	M12	YAR 208-2RFGR/HV

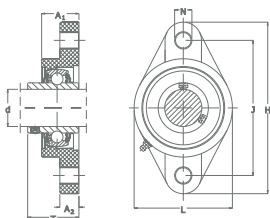

**FYTL housing**  
(with zinc-coated bearing)



Unit designation	d		A <sub>1</sub>	A <sub>2</sub>	H	J	L	N	T	Bolt size	Bearing designation
	mm	inch									
FYTL 20 TR/VE495	20		26,5	11,4	113	90	65	11	33,3	M10	YAR 204-2RF/VE495
FYTL 25 TR/VE495	25		29,1	13,5	130	99	70	11	35,8	M10	YAR 205-2RF/VE495
FYTL 30 TR/VE495	30		30,5	13,3	148	117	80	11	40,2	M10	YAR 206-2RF/VE495
FYTL 35 TR/VE495	35		32,8	16,1	163	130	90	13	44,4	M12	YAR 207-2RF/VE495
FYTL 40 TR/VE495	40		37,5	20	176	144	100	14	51,2	M12	YAR 208-2RF/VE495

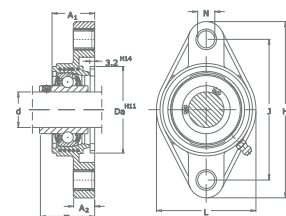

**FYTBKC grey Y-TECH housing**  
(with stainless steel bearing)



Unit designation	d		A <sub>1</sub>	A <sub>2</sub>	D <sub>3</sub>	H	J	L	N	T	Bolt size	Bearing designation
	mm	inch										
FYTBKC 20 NTH	20		29,5	15	50,8	112	90	60,5	12	37,3	M10	YAR 204-2RF/HV
FYTBKC 25 NTH	25		30	15	63,5	124	99	70	12	38,8	M10	YAR 205-2RF/HV
FYTBKC 30 NTH	30		33	15	76,2	142,5	116,5	83	12	42,2	M10	YAR 206-2RF/HV
FYTBKC 35 NTH	35		35	17	88,9	156	130	96	14,5	46,4	M12	YAR 207-2RF/HV

# Short base unit with composite housing

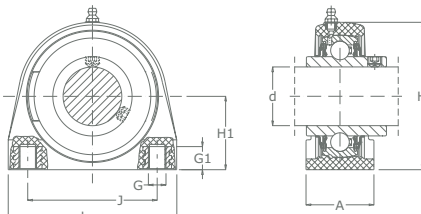

**SYFL housing**  
(with stainless steel bearing)



Unit designation	d		A	H	H <sub>1</sub>	J	L	G <sub>1</sub>	G	Bearing designation
	mm	inch								
SYFL 3/4 TH		3/4	34,5	66	33,3	50,8	72,8	12	M8	YAR 204-012-2RF/HV
SYFL 20 TH	20		34,5	66	33,3	50,8	72,8	12	M8	YAR 204-2RF/HV
SYFL 25 TH	25		39,5	73,5	36,5	50,8	76,2	12	M10	YAR 205-2RF/HV
SYFL 1. TH		1	39,5	73,5	36,5	50,8	76,2	12	M10	YAR 205-100-2RF/HV
SYFL 30 TH	30		42,5	84	42,9	76,2	101	12	M10	YAR 206-2RF/HV
SYFL 1.1/4 TH		1.1/4	47,5	95	47,6	82,6	110	15,5	M10	YAR 207-104-2RF/HV
SYFL 35 TH	35		47,5	95	47,6	82,6	110	15,5	M10	YAR 207-2RF/HV
SYFL 1.1/2 TH		1.1/2	48	100,5	49,2	88,9	120	16	M12	YAR 208-108-2RF/HV
SYFL 40 TH	40		48	100,5	49,2	88,9	120	16	M12	YAR 208-2RF/HV

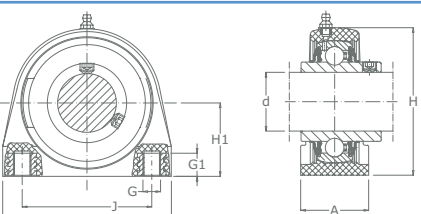

**SYFL housing**  
(with zinc-coated bearing)



Unit designation	d		A	H	H <sub>1</sub>	J	L	G <sub>1</sub>	G	Bearing designation
	mm	inch								
SYFL 20 TR/VE495	20		34,5	66	33,3	50,8	72,8	12	M8	YAR 204-2RF/VE495
SYFL 25 TR/VE495	25		39,5	73,5	36,5	50,8	76,2	12	M10	YAR 205-2RF/VE495
SYFL 30 TR/VE495	30		42,5	84	42,9	76,2	101	12	M10	YAR 206-2RF/VE95
SYFL 35 TR/VE495	35		47,5	95	47,6	82,6	110	15,5	M10	YAR 207-2RF/VE495
SYFL 40 TR/VE495	40		48	100,5	49,2	88,9	120	16	M12	YAR 208-2RF/VE495

# Take-up unit with composite housing

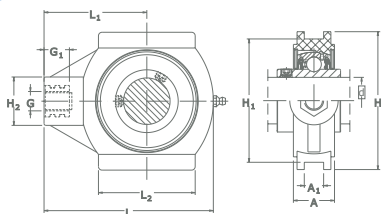

**TUL housing**  
(with stainless steel bearing)



Unit designation	d		A	A <sub>1</sub>	H	H <sub>1</sub>	H <sub>2</sub>	L	L <sub>1</sub>	L <sub>2</sub>	G <sub>1</sub>	G	Bearing designation
	mm	inch											
TUL 3/4 TH		3/4	27,5	12	89	76	36	99	64	46	21	M16	YAR 204-012-2RF/HV
TUL 20 TH	20		27,5	12	89	76	36	99	64	46	21	M16	YAR 204-2RF/HV
TUL 25 TH	25		27,5	12	89	76	36	99	64	46	21	M16	YAR 205-2RF/HV
TUL 1. TH		1	27,5	12	89	76	36	99	64	46	21	M16	YAR 205-100-2RF/HV
TUL 30 TH	30		34	12	102	89	40	125	76	63	21	M16	YAR 206-2RF/HV
TUL 1.1/4 TH		1.1/4	34	12	102	89	40	125	76	63	21	M16	YAR 207-104-2RF/HV
TUL 35 TH	35		34	12	102	89	40	125	76	63	21	M16	YAR 207-2RF/HV
TUL 1.1/2 TH		1.1/2	34	16	114	102	40	140	85	80	21	M16	YAR 208-108-2RF/HV
TUL 40 TH	40		34	16	114	102	40	140	85	80	21	M16	YAR 208-2RF/HV

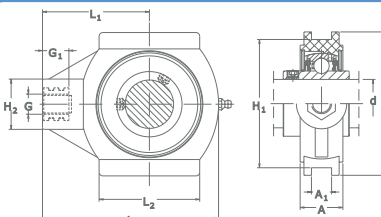

**TUL housing**  
(with zinc-coated bearing)



Unit designation	d		A	A <sub>1</sub>	H	H <sub>1</sub>	H <sub>2</sub>	L	L <sub>1</sub>	L <sub>2</sub>	G <sub>1</sub>	G	Bearing designation
	mm	inch											
TUL 20 TR/VE495	20		27,5	12	88	76	36	99	64	47	21	M16	YAR 204-2RF/VE495
TUL 25 TR/VE495	25		27,5	12	88	76	36	99	64	47	21	M16	YAR 205-2RF/VE495
TUL 30 TR/VE495	30		34	12	102	89	40	125	76	63	21	M16	YAR 206-2RF/VE495
TUL 35 TR/VE495	35		34	12	102	89	40	125	76	63	21	M16	YAR 207-2RF/VE495
TUL 40 TR/VE495	40		34	16	114	102	40	140	85	80	21	M16	YAR 208-2RF/VE495

# Resistance to chemical agents

Substance	Stainless Steel	NBR	Polyamide	Polyester
Acetic acid diluted	+	++	++	++
Acetic acid concentrated	-	-	-	-
Acetone	+	-	++	++
Beer	++	++	++	++
Butter	++	++	++	++
Chlorine (dry)	++	++	++	++
Citric acid	++	++	++	++
Cooking fats	++	++	++	++
Ethanol	++	+	++	++
Methanol	++	+	++	++
Milk	++	++	++	++
Potassium hydroxide	++	++	++	++
Soap	++	++	++	++
Sodium hydroxide diluted	+	+	+	+
Sodium hydroxide concentrated	-	-	-	-
Sulphuric acid	+	+	+	+
Water	++	++	++	++
Wine	+	+	+	+

**LEGEND**

- ++ : Good resistance
- + : Practical tests in operating conditions advisable.
- : Not recommended

Food Line units are suitable to work in many humid and aggressive environments.

The chemical resistance of these materials is heavily affected from percentage of the aggressive, time and temperature of exposure. For any chemical agent it is always recommended to test the unit on field or to carry an immersion test in proper conditions.

## End covers

**Fit KC design units**

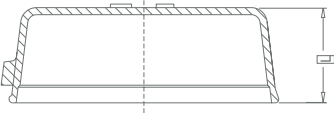

**ECY 2XX**

**Fit L design units**

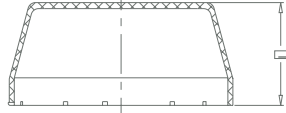

**ECL 2XX - Close**

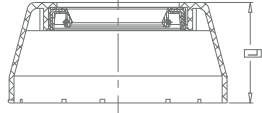

**ECL 2XX B - Open**

When using open end covers, the speed should not exceed 500 r/min due to combined effect of the bearing sealing system (-2RF) and the garter seal of the end cover.

**ECY**  
Closed end cover for Y-Tech housings  
(black)

Cover designation	d		L mm
	mm	inch	
ECY 204	20		23
ECY 205	25		23
ECY 206	30		25
ECY 207	35		27
ECY 208	40		28,5

**ECL**  
Closed end cover for L housings  
(light-grey)

Cover designation	d		L mm
	mm	inch	
ECL 204	20	3/4	23
ECL 205	25	1	25
ECL 206	30		30
ECL 207	35	1.1/4	32
ECL 208	40	1.1/2	37

**ECL ... B**  
Open end cover for L housings  
(light-grey)

Cover designation	d		L mm
	mm	inch	
ECL 204-012 B		3/4	23
ECL 204 B	20		23
ECL 205 B	25		25
ECL 205 100 B		1	25
ECL 206 B	30		30
ECL 207-104 B		1.1/4	32
ECL 207 B	35		32
ECL 208-108 B		1.1/2	37
ECL 208 B	40		37

® SKF is a registered trademark of the SKF Group.

© Copyright SKF 2006

The contents of this publication are the copyright of the publisher and may not be reproduced (even extracts) unless permission is granted. Every care has been taken to ensure the accuracy of the information contained in this publication but no liability can be accepted for any loss or damage whether direct, indirect or consequential arising out of the use of the information contained herein.

Publication **1891 E/II** - 01/06

