

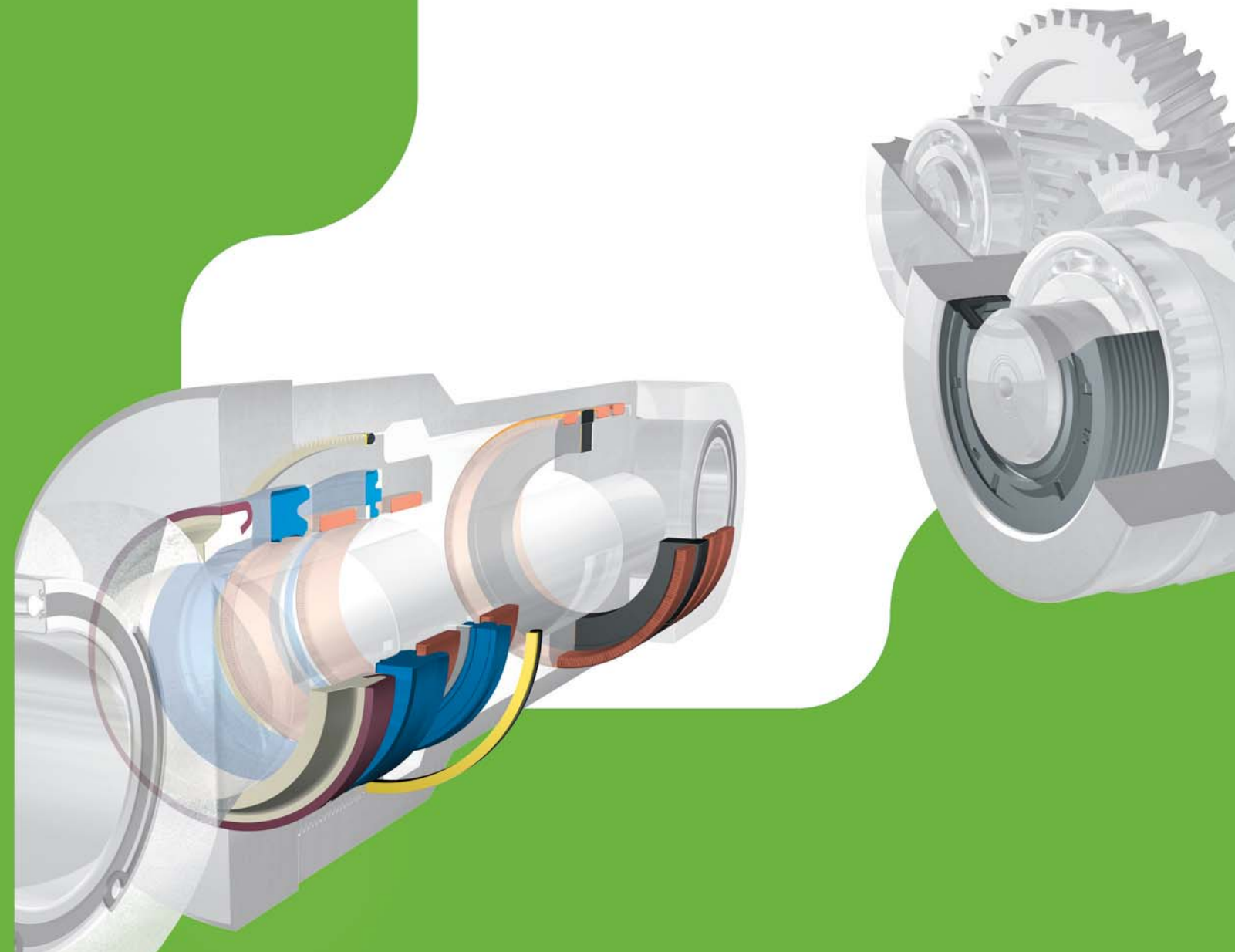

SKF Industrial seals

Product overview



© Copyright SKF 2005

Every care has been taken to ensure the accuracy of the information contained in this publication but no liability can be accepted for any loss or damage whether direct, indirect or consequential arising out of the use of the information contained herein.

SKF Publication 5244E/II

SKF and the SKF logo are trademarks of the SKF Group and are registered in certain jurisdictions.

Printed in Germany on environmentally friendly, chlorine-free paper.



The knowledge engineering company

Nearly 100 years of experience and the resulting knowledge that has been accumulated through its own research, and through development of value propositions for its customers in a broad range of industries, have established the SKF Group as a leader in its field. This leadership extends far beyond bearings and seals.

Today SKF is focused on five platforms that cover its technical knowledge and capabilities. The five platforms include: Bearings and units, Seals, Mechatronics, Services and Lubrication Services. SKF utilizes the capabilities of all these platforms to offer its customers a tailor-made proposition that will, in turn, strengthen their offer to their customers or that would make their own production more effective. Whether reducing energy consumption or the need for lubricants, SKF innovative solutions can help safeguard earth's limited resources for future generations.

The Group has a global ISO 14001 environmental certification. Individual divisions have been approved for quality certification in accordance with either ISO 9000 or QS 9000. Some 80 manufacturing sites worldwide and sales companies in 70 countries make SKF a truly international corporation. In addition, our 7 000 distributors and dealer partners around the world, the e-business marketplace and global distribution system put SKF close to customers for the supply of both products and services. In essence, SKF solutions are available wherever and whenever our customers need them. Overall, the SKF brand now stands for more than ever before. It stands for the knowledge engineering company ready to serve you with world-class product competencies, intellectual resources and the vision to help you succeed.

Seals and sealing technology are essential parts of the capabilities of SKF. Seals from SKF stand for excellence and leadership and symbolize consistent endeavour to achieve total quality in all processes and imply three main benefits for our customers:

Reliability – thanks to modern, efficient products, based on worldwide application know-how, optimized materials, forward-looking designs and the most advanced production techniques.

Market lead – an advantage of our products and services. Our customers increase operating time, reduce downtime, and improve output and product quality.

Cost effectiveness – resulting from the favourable ratio between our product quality plus service facilities and the purchase price of the product.

This publication is aimed to provide an overview of the SKF seals, their design characteristics and their suitability for different application conditions. It presents the SKF product range of seals, which is available throughout the world. No matter what your requirements are, SKF can help you get exactly the right sealing arrangement for your application. And you are welcome to share the SKF expertise in sealing technology.

This publication is designed to enable the information regarding a particular product to be quickly and easily accessed. The contents are divided into the five sections

- Radial shaft seals
- Wear sleeves
- Axial shaft seals
- Hydraulic seals
- Static seals

All products are listed with a brief description informing about design and properties. Detailed information on SKF seals can be found in the catalogues

- SKF Industrial shaft seals
- SKF Hydraulic seals

which are available from your local SKF representative. In addition the SKF application engineering services can provide support when designing a sealing arrangement.

SKF Industrial seals product structure

Contents

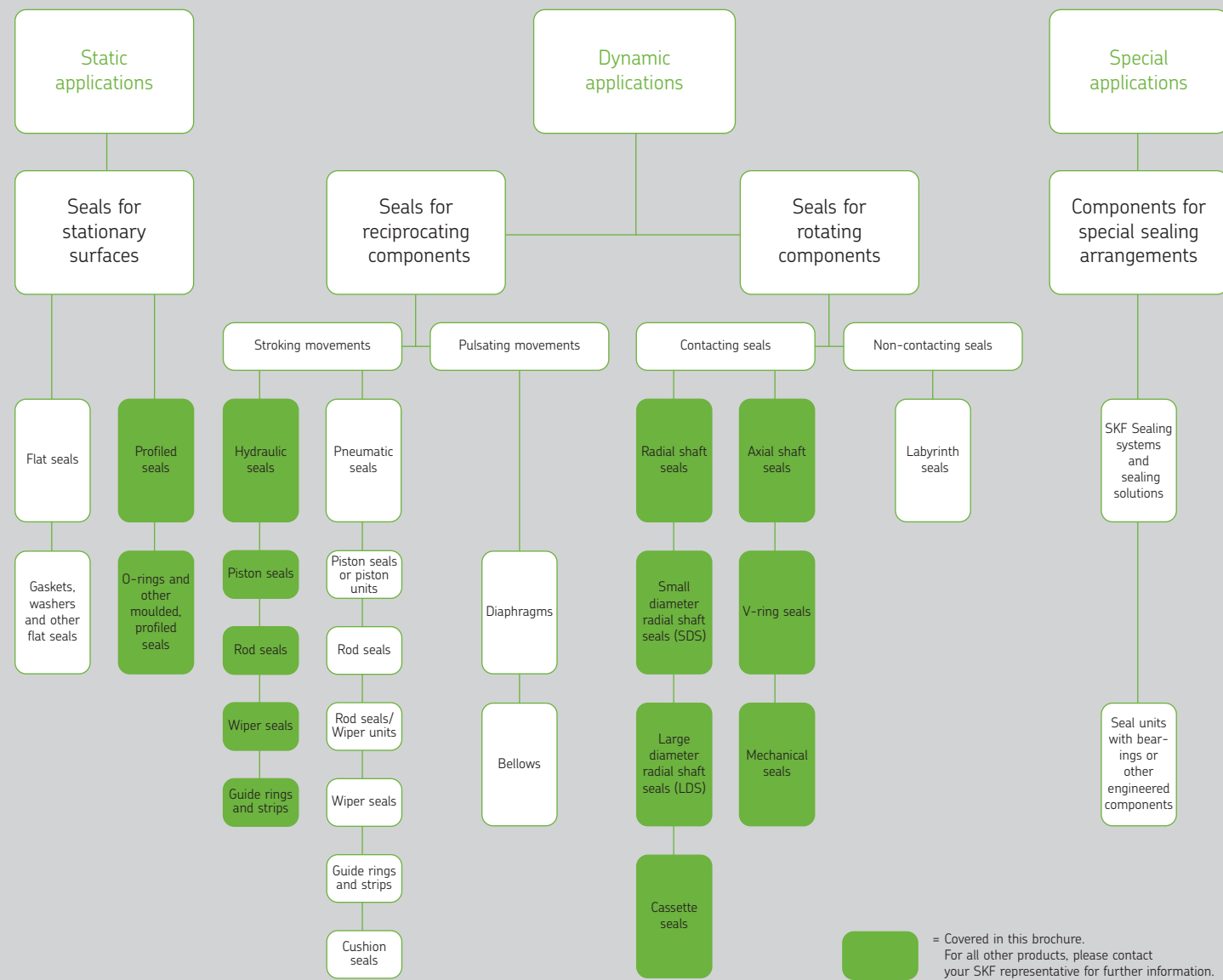

Radial shaft seals	6
Sealing lip material overview	8
Small diameter radial shaft seals	10
□ Seals of nitrile or fluoro rubber	12
□ Seals of PTFE materials	16
□ Selection factor matrix	14
Large diameter radial shaft seals	20
□ Seals with metal case	24
□ Fabric-reinforced seals	25
□ Steel-reinforced seals	26
□ All-rubber seals	27
□ Permissible operating conditions	28
Cassette seals and shaft sealing units	32
Other SKF radial shaft seal designs	36
Wear sleeves	40
Axial shaft seals	42
V-ring seals	44
Metal-clad V-type sealing rings and axial clamp seals	46
Mechanical seals	47
Hydraulic seals	48
Material overview	50
Piston seals	52
□ Selection matrix	64
Rod seals	66
□ Selection matrix	78
Wiper seals	80
□ Selection matrix	90
Guides	92
Static seals	94
Product index	98

Radial shaft seals



Whenever a shaft rotates, it needs a bearing arrangement for smooth and effective operation. Wherever there is a bearing, you will always find a seal helping it to reach its maximum service life and reliability. The most common types of seals used in bearing arrangements, are radial shaft seals for use in general industrial applications with shaft diameters up to 200 mm or 8 inch respectively. The large diameter seals, for shaft diameters above 200 mm, provide special features and are intended for use in heavy and large-size engineering applications, which require either very large or specially designed seals. In general terms, a radial shaft seal is a barrier with four main functions:

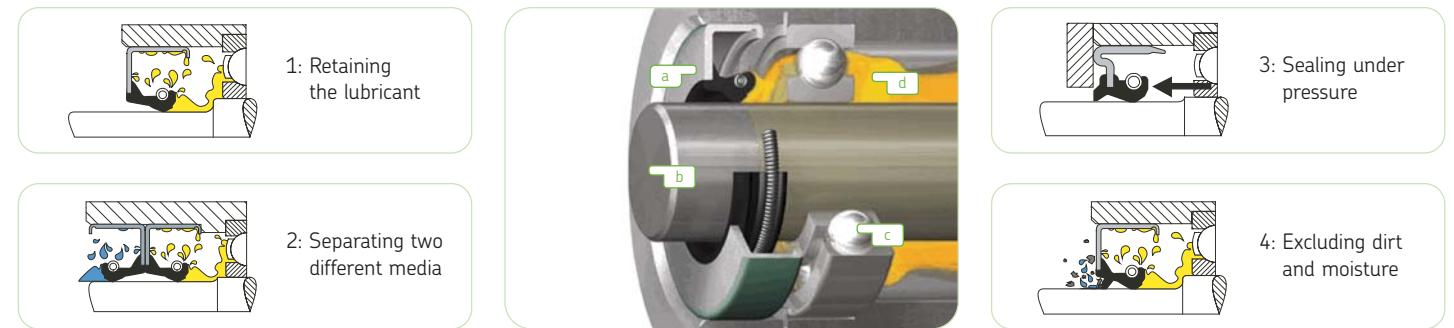

a: Radial shaft seal
b: Shaft
c: Bearing
d: Lubricant

On the following pages, the standard range of our radial shaft seals is presented, with a short description of the main features for each seal type and design and recommendations regarding selection and application. Obviously, in this publication, it is not possible to cover all the technical aspects sufficiently for all individual application requirements. Therefore, reference should be made in general to the catalogue "SKF Industrial shaft seals", where comprehensive, technical data for each type and design can be found. For information about availability and delivery time for the assortment of SKF radial shaft seals, please contact your nearest SKF representative or authorized distributor.

Radial shaft seals

Sealing lip material overview



HDL, HMS5 RG, CRW1, CRWHA1, RDD13

In addition to seal design, the sealing lip material significantly contributes to seal performance and reliability. To cater for the different demands of applications, SKF seals are produced in a variety of sealing lip materials, see list below. These materials have characteristics, individual properties, making them particularly suitable for specific applications.

Details about physical properties and the chemical resistance of the seal materials to various media encountered in operation will be found in the section "Chemical resistance" in the catalogue "SKF Industrial shaft seals".

Codes are used to identify the sealing lip material of SKF seals and are listed in the table below. The codes also appear in the designations of the radial shaft seals. For seals produced in a combination of materials, a combination of the code letters is used, e.g. RV (nitrile rubber with fluoro rubber).

SKF sealing lip materials			
Composition of basic material	Designation according to		Nominal operating temperature range
	SKF	ISO / ASTM	
Acrylonitrile-butadiene rubber (nitrile rubber)	R	NBR	-50 to +100 °C (-60 to +210°F)
Hydrogenated acrylonitrile-butadiene (Duratemp) rubber	H	HNBR	-30 to +150 °C (-20 to +300°F)
Carboxylic-acrylonitrile-butadiene rubber (Duralip)	D	XNBR	-50 to +100 °C (-60 to +210°F)
Fluoro rubber (LongLife)	V	FKM	-40 to +200 °C (-40 to +390°F)
Polytetrafluoroethylene	T	PTFE	-200 to +260 °C (-330 to +500°F)



Radial shaft seals

Small diameter radial shaft seals



SKF small diameter radial shaft seals constitute the most common seals and normally fit shaft diameters ranging from 3 to 200 mm or 0,125 to 8 inch respectively. These contact seals are available in a large variety of designs and types, made of different materials. They are intended for use in all industrial segments.



This chapter presents the most commonly used small diameter radial shaft seals within the SKF range. Most of these seals conform to one of the designs standardized in the international or national standards, for example ISO/ASTM, DIN or JIS.

In addition to the standard design seals presented on the following pages, SKF also manufactures a wide range of customized designs. A comprehensive selection of these customized seals is shown in chapter "Other SKF radial shaft seal designs" on pages 36 to 39. In case of demand for any of these designs, please contact your local SKF sales representative.

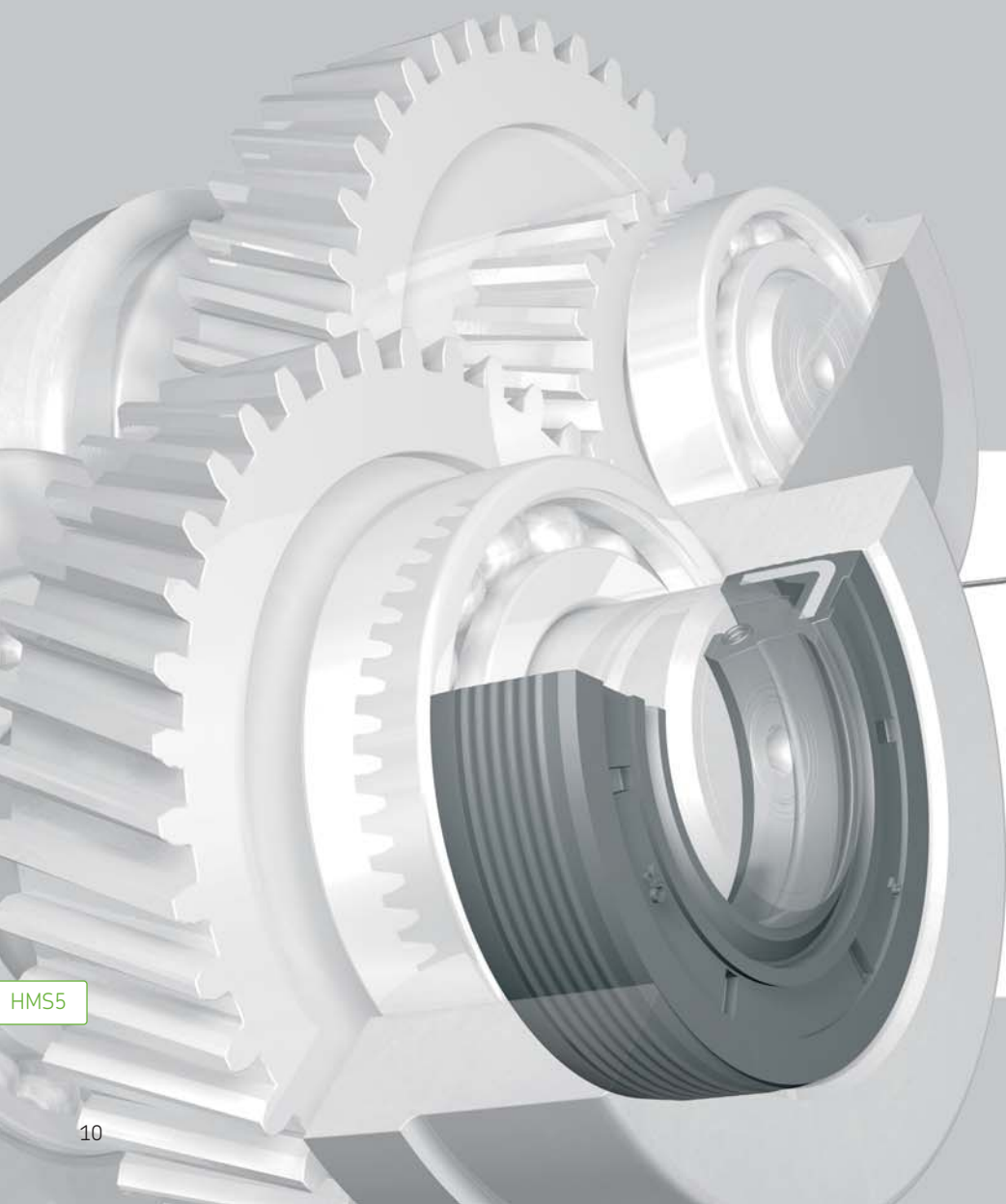

Small diameter radial shaft seals of nitrile or fluoro rubber

Series HMS5 and HMSA10

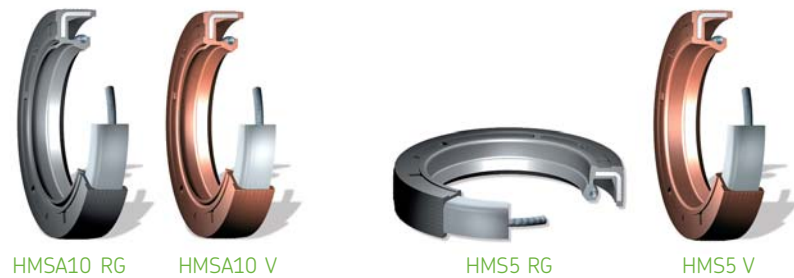

This new line of SKF radial shaft seals is designed in accordance with ISO 6194 and DIN 3760 for use in a wide range of applications within all industrial areas, e.g. gearboxes. The rubber covered outside diameter provides optimised sealing ability in the housing, also at considerable surface roughness, thermal expansion or a split housing. These seal types are also appropriate for sealing lubricants with low viscosity or gaseous media.

Specific features

- New optimised material compound
- Spring loaded and trimmed sealing lip
- Sealing lip and flex section optimally balanced for lowest possible radial load on the shaft
- Centring notches to secure a proper positioning of the outside and inside diameters
- Beaded outside diameter for an improved sealing ability and to secure retention in the housing as well as to prevent spring back effect at assembly
- Secondary (dust) lip of HMSA10 with zero lip/shaft interference for extended protection against contaminations

Material

The new nitrile rubber compound (SKF 3243) is a result of long experience and the latest findings from the SKF seal material developments. Seals in this compound have the designation suffix RG.

Main material features of SKF 3243 are:

- Very good compatibility to synthetic oils
- Very good pumping ability
- Good wear resistance
- Good resistance against ageing

The pumping ability is defined by the time it takes for the seal to return a certain amount of oil from the airside to the oil side. The shorter time the more effective is the seal to prevent leakage. The microstructure of the SKF 3243 compound is resulting in that the seal will instantly pump back the oil.

The complete range of series HMS5 and HMSA10 is also available in a fluoro rubber compound (SKF 496) with a stainless garter spring. Seals of fluoro rubber have the designation suffix V and are used in applications with temperatures and speeds beyond the limits of nitrile rubber.

Size range

The available size range of HMS5 and HMSA10 includes a full coverage of the ISO 6194 and DIN 3760 dimensions up to 250 mm shaft sizes.

Series HMS4, HMSA and CRS

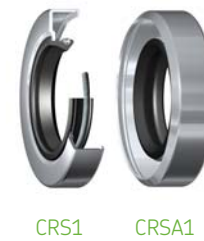

Seals with straight-edged sealing lips are particularly versatile and applicable in all industrial segments. They are suitable for split and/or light alloy housings with increased thermal expansion and/or poor surface quality in the housing bore. Advantageous for static sealing in housing against low viscosity liquid or gaseous media. The secondary lip of HMSA7 seals keeps dirt away from the sealing lip.

- HMS4: Seal with rubber outside diameter, carbon steel reinforcement ring, garter spring of carbon steel or stainless steel and straight-edged sealing lip.
- HMSA7: Seal with rubber outside diameter, carbon steel reinforcement ring, garter spring of carbon steel or stainless steel, straight-edged sealing lip and a secondary contacting (dust) lip.

SKF radial shaft seals of HMS4 and HMSA7 design are stocked in a wide range of sizes. Both seal designs are available either made of nitrile or fluoro rubber.

Detailed information about technical data, size range and recommendations about machining and installation can be found in catalogue "SKF Industrial shaft seals" or on the SKF website www.skf.com.

SKF radial shaft seals with steel shell are relatively easy to install and, provided the housing bore meets the accurate requirements, they will fit tightly and centrally in the housing bore.

- CRS1: Radial shaft seal with straight-edged sealing lip, carbon steel garter spring and a steel shell.
- CRSH1: Radial shaft seal of high stiffness with straight-edged sealing lip, carbon steel garter spring and a steel case, reinforced by an inner case.
- CRSA1: Radial shaft seal with straight-edged sealing lip, carbon steel garter spring, a contacting secondary (dust) lip and a steel case.
- CRSHA1: Radial shaft seal of high stiffness with straight-edged sealing lip, carbon steel garter spring, a contacting secondary (dust) lip and a steel case, reinforced by an inner case.

All CRS design radial shaft seals are stocked in a wide range of sizes. They are available either made of nitrile or fluoro rubber.

Detailed information about technical data, size range and recommendations about machining and installation can be found in catalogue "SKF Industrial shaft seals" or on the SKF website www.skf.com.



Small diameter radial shaft seals of nitrile or fluoro rubber

Low-friction Waveseal® series

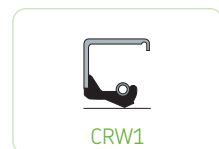

CRW1

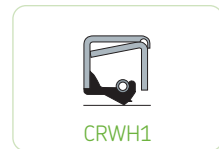

CRWH1



CRWA1

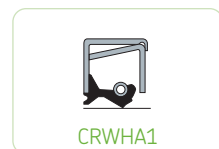

CRWHA1

SKF low-friction Waveseal series is designed for a very wide range of applications. These long-lasting seals with reduced heat generation are easy to install and provide a firm and accurate seating in the housing bore. Primarily intended for lubricant retention. Seals in the CRWA1 and CRWHA1 design are equipped with a secondary lip to exclude dust and light contamination.

These low-friction Waveseal types are available made of either nitrile rubber or fluoro rubber and are stocked in a wide range of sizes.

Seals with a Waveseal sealing lip are coated on the outside diameter with Bore-Tite, a non-hardening, water-based polyacrylate sealant, which helps to fill out small imperfections in the housing bore.

□ CRW1: Radial shaft seal with Waveseal sealing lip, carbon steel garter spring, steel case, and Bore-Tite coated outside diameter.

□ CRWH1: Radial shaft seal of high stiffness with Waveseal sealing lip, carbon steel garter spring, steel case reinforced by an inner case, and Bore-Tite coated outside diameter.

□ CRWA1: Radial shaft seal with Waveseal sealing lip, carbon steel garter spring, a non-contacting secondary lip, steel case, and Bore-Tite coated outside diameter.

□ CRWHA1: Radial shaft seal of high stiffness with Waveseal sealing lip, carbon steel garter spring, a non-contacting secondary lip, steel case reinforced by an inner case, and Bore-Tite coated outside diameter.

Detailed information about technical data, size range and recommendations about machining and installation can be found in catalogue "SKF Industrial shaft seals" or on the SKF website www.skf.com.

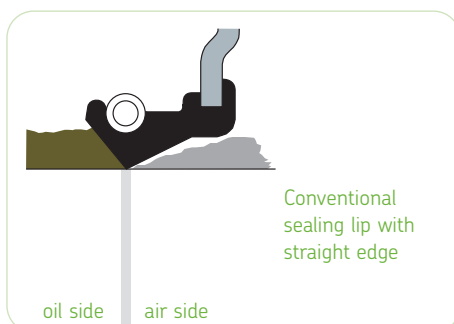

Conventional sealing lip with straight edge

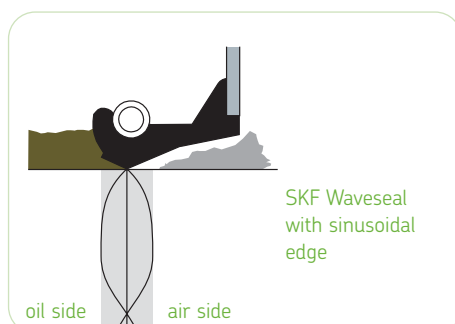

SKF Waveseal with sinusoidal edge

Seals with Waveseal® pressure profile

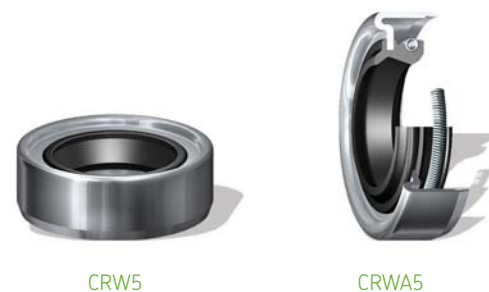

CRW5

CRWA5

Seals with Waveseal® pressure profile are designed for applications where pressure differential across the seal is higher than normal. They are easy to install and provide a firm and accurate seating in the housing bore. Primarily intended for lubricant retention, but the CRWA5 design is equipped with a non-contacting secondary lip to exclude dust and light contamination.

- CRW5: Radial shaft seal with Waveseal pressure profile sealing lip, carbon steel garter spring, steel case, and Bore-Tite coated outside diameter.
- CRWA5: Radial shaft seal with Waveseal pressure profile sealing lip, carbon steel garter spring, a non-contacting secondary lip, steel case, and Bore-Tite coated outside diameter.

SKF seals with Waveseal® pressure profile sealing lips are only partially available from stock, but can be delivered to short notice.

Note: Where there is a pressure differential across the seal, the seal should be axially secured in the housing bore.

For information about Bore-Tite, please see page 14.

Detailed information about technical data, size range and recommendations about machining and installation can be found in catalogue "SKF Industrial shaft seals" or on the SKF website www.skf.com.



CRW5



CRWA5

Small diameter radial shaft seals, PTFE lip material

PTFE radial shaft seals with metal case



RD10 RD11

SKF radial shaft seals of series RD with sealing lip(s) made of PTFE are protected by a metal case and one or two additional inner cases. They are designed to withstand aggressive environments, high temperatures, high pressures and dry running of the sealing lip(s).

These PTFE radial shaft seals of RD design are available in several variants. The metal case can be made from aluminium, carbon steel or stainless steel. For the sealing lips different PTFE compounds are used, including materials, which fulfill US Food and Drug Administration regulations.

The nominal dimensions of the PTFE radial shaft seals are in accordance with ISO 6194/1:1982 and DIN 3760-1996, which enables them e.g. to replace traditional radial shaft seals in existing applications.

RD radial shaft seals are manufactured by SKF on demand and can be delivered with short notice.

Detailed information about technical data, possible size range and recommendations about machining and installation can be found in catalogue "SKF Industrial shaft seals" or on the SKF website www.skf.com.



RD30 RD60



RD70 RD71

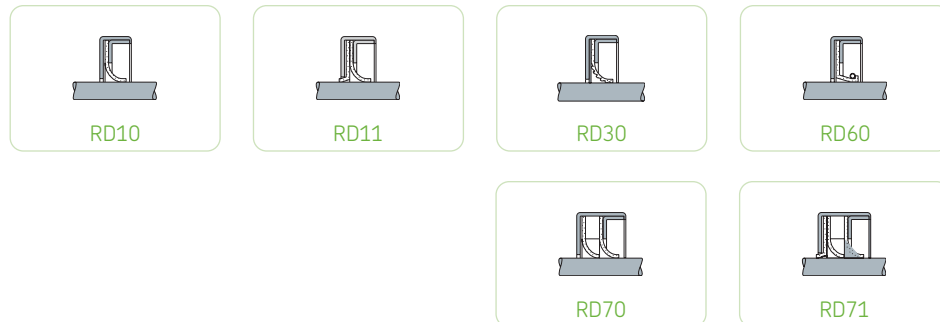

All-PTFE radial shaft seals



RDD13



RDD14 RDD15

SKF radial shaft seals series RDD, made purely of PTFE without a metal case, are intended for the use in the food industry and withstand aggressive environments, temperatures below -40 °C (-40 °F), high pressures and dry running of the sealing lip(s). An O-ring is installed in the groove of the outside diameter surface to provide excellent static sealing ability. The O-ring material can be chosen to meet the operating conditions.

RDD design seals have the same nominal dimensions and the same technical specifications as seals in the RD design with a metal case, which enables them to be installed in the same housings.

PTFE radial shaft seals of RDD design are manufactured on demand and can be delivered with short notice.

Detailed information about technical data, possible size range and recommendations about machining and installation can be found in catalogue "SKF Industrial shaft seals" or on the SKF website www.skf.com.

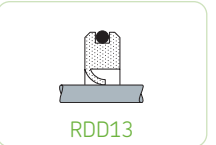

RDD13

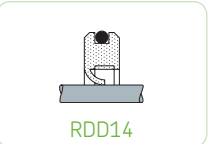

RDD14

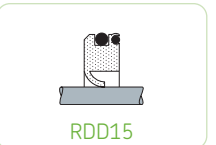

RDD15























Small diameter radial shaft seals, selection matrix

This matrix can only provide a rough guide and the final seal selection should only be made after a more detailed examination of sealing properties with respect to the actual operating conditions and environment. If several seal designs and materials are shown together then the ratings apply to the specified design/material.

Signs and symbols:

- +++ Very well suited (very good)
 - ++ Well suited (good)
 - + Suitable (normal)
 - Less suitable (satisfactory)
 - Unsuitable (poor)
- R Nitrile rubber
 - V Fluoro rubber

Seals types

Design				Suitability																				
Case (outside diameter)		Sealing lip		Secondary lip	Seating conditions					Pressure differential		Operating conditions					Media							
Steel	Elastomer (Plastomer)	Design	Material	A = contacting B = non-contacting	Tight fit	Rough surface	Thermal expansion	Split housing bore	Ease of installation	Housing bore/ outside diameter	Sealing lip/ counterface	Sliding speeds < 14 m/s (< 2 755 ft/min)	Sliding speeds > 14 m/s (> 2 755 ft/min)	Temperatures < 100°C (< 210°F)	Temperatures > 100°C (> 210°F)	Runout	Coaxiality deviation	Grease	Oil	Moderate particulate contamination	Heavy particulate contamination	Aggressive media		
HMS5 	HMSA10 	-	RG, V	normal	RG, V	B (HMSA10)	+++	+++	+++	+++	++	++	+	+	-	+	V	+	+	+++	+++	+++ HMSA10	+++	++ (V)
HMS4 	HMSA7 	-	R, V	normal	R, V	A (HMSA7)	++	++	++	++	+	++	+	+	-	+	V	+	+	++	+++	++ HMSA7	+	++ (V)
CRW1 	CRWH1 	+	-	Wave-seal	R, V	-	+++ CRWH	+	-	--	+	++	+++	++	+	+	V	+	+	++	+++	+	+	++ (V)
CRWA1 	CRWHA1 	+	-	Wave-seal	R, V	-	+++ CRWHA	+	-	--	+	++	+++	++	+	+	V	+	+	++	+++	++	+	++ (V)
CRW5 	CRWA5 	+	-	Wave-seal	R, V	B (CRWA5)	++	+	-	--	+	++	+++	++	+	+	V	+	+	++	+++	+	+	++ (V)
CRS1 	CRSH1 	+	-	normal	R, V	-	+++ CRSH	-	-	--	+	+	-	+	-	+	V	+	+	+	++	+	+	++ (V)
CRSA1 	CRSHA1 	+	-	normal	R, V	A	+++ CRSHA	-	-	--	+	+	-	+	-	+	V	+	+	+	++	++	+	++ (V)
RD10 	RD30 	RD60 	-	special	PTFE	-	++	-	-	-	+	++	+++	+++	+++	+++	+++	+	+	+++	+++	-	+++	+++
RD11 	RD70 	RD71 	-	special	PTFE	RD11, RD71	++	-	-	-	+	++	+++	+++	+++	+++	+++	+	+	+++	+++	RD11 RD71	+++	+++
RDD13 	RDD14 	RDD15 	-	special	PTFE	-	++ 1)	++ 1)	++ 1)	-	-	++	+++	+++	+++	+++	+++	+	+	+++	+++	-	+++	+++

1) together with a separate static seal

Radial shaft seals

Large diameter radial shaft seals



Heavy and large-size engineering applications such as metallurgical works, rolling mills, mining and construction, pulp and paper, wind energy or forestry provide a challenging environment for radial shaft seals. Operating in a wide range of speeds, temperatures, and environmental conditions radial shaft seals are supposed to reliably retain lubricants while preventing any contamination from entering into the interior.

Generally, radial shaft seals for shaft diameters larger than 200 mm or 8 inch are known as large diameter radial shaft seals. These large diameter radial shaft seals are available from SKF in a variety of heavy-duty styles, configurations and materials:

- Seals with metal case
- Fabric-reinforced seals
- Steel-reinforced seals
- All-rubber seals

The excellent performance of SKF large diameter seals can be exploit in different ways depending on the requirements and make them indispensable in many areas. They are frequently used in the applications listed below. Other areas of usage include plastic calenders, grinding mills, drive spindles of rolling mills, hoisting equipment, rotary tables of drilling rigs or all other large-size installations.

As a general recommendation, these different designs are suitable in applications as follows:

Seal designs	Applications			
	Wire rod rolling mills Light section rolling mills Heavy and large machinery Large industrial gearboxes	Hot strip rolling mills Hot plate rolling mills Cold rolling mills Large industrial gearboxes	Several rolling mills Heavy and large machinery Large industrial gearboxes	Special machinery: crushers, shredders, bailers
	General purpose	Grease retention, water and scale exclusion	Oil lubrication, high-speed application (>25 m/s, 4 290 ft/min)	High deviation from coaxiality and runout
HDS7	0	3	0	0
HDL	2	1	3	3
HDS1,2,3	3	2	0	0
HDS4, HDS6	2	2	3	2
SBF, HSF	3	1	0	0

3 - Very well suited, 2 - Well suited, 1 - Suitable, 0 - Not recommended

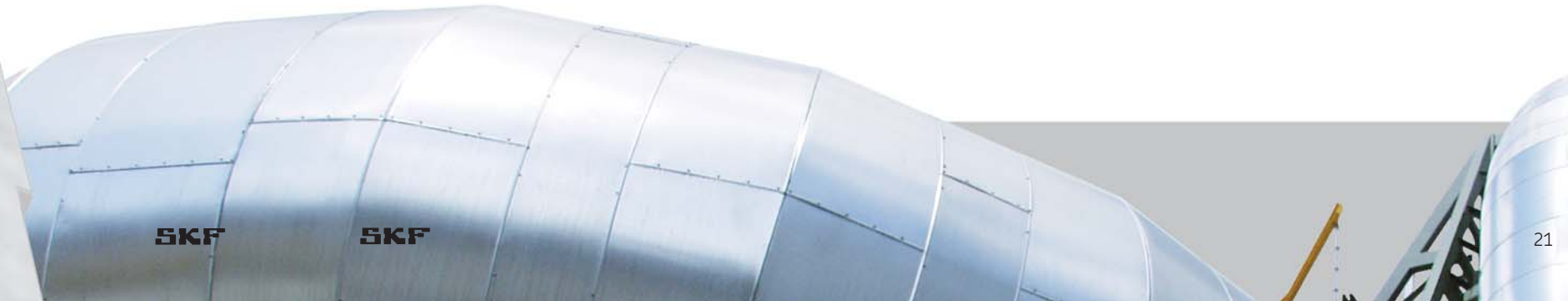

Large diameter radial shaft seals

Seals with metal case



HDS7



HDS7



SKF extra performance heavy-duty seals in the HDS7 design are especially developed for grease lubricated applications and provide enhanced exclusion capabilities. They consist of a robust steel case, an elastomeric body and a low-friction sealing lip without garter spring. The increased ability of the HDS7 seals to retain grease and to exclude contamination make them suitable for applications where protection is required e.g. against water or scale.

The HDS7 seals are manufactured by SKF on demand, optionally made of

- nitrile rubber (NBR)
- hydrogenated nitrile rubber (HNBR)
- carboxylic-acrylonitrile-butadiene rubber (XNBR)

Short information about permissible operating conditions is given in the table on pages 28 and 29. For detailed technical information and recommendations about machining and installation, please refer to catalogue "SKF Industrial shaft seals" or the SKF website www.skf.com.

SKF premium class heavy-duty seals in the HDL design are intended for highly demanding sealing arrangements, which have to withstand severe operating conditions, including high speeds and temperatures, high deviations in runout, large misalignments and where service life is a key operational parameter.



HDL



HDLP



HDL



HDLP

The HDL seals incorporate a stainless steel garter spring that is entrapped by individual finger springs around the entire circumference of the seal, which are made of stainless steel. This spring combination enables the seal to perform efficiently with a minimum of friction and wear for a long-lasting service life.

SKF seals in the HDL design are available with sealing lips made of

- nitrile rubber (NBR)
- carboxylic-acrylonitrile-butadiene rubber (XNBR)
- fluoro rubber (FKM)

The premium heavy duty seals in the HDLP design are equipped with a non-contacting secondary (dust) sealing lip.

Brief information about permissible operating conditions is given in the table on pages 28 and 29. For detailed technical data, recommendations about machining and installation as well as for information about available sizes, please refer to catalogue "SKF Industrial shaft seals" or the SKF website www.skf.com.



HDS1



HDS2



HDS3

SKF heavy-duty seals in the HDS series are designed with a steel case and one sealing lip. They are the most commonly used large diameter radial shaft seals for general-purpose applications. In order to meet the varying demands of the wide application field of these HDS series seals, the elastomeric body and sealing lip can be made of different materials:

- nitrile rubber (NBR)
- hydrogenated nitrile rubber (HNBR)
- carboxylic-acrylonitrile-butadiene rubber (XNBR)
- fluoro rubber (FKM)

HDS1: Heavy-duty seal with robust steel case. Body and sealing lip are made of NBR, as standard. The stainless steel garter spring is mounted in a "Spring-Lock" groove, which encloses some 270° of the spring and keeps the spring in position even under difficult installation conditions.

HDS2: Heavy-duty seal with robust steel case. Body and sealing lip are made of NBR, as standard. The stainless steel garter spring is mounted in a "Spring-Lock" groove and additionally protected against contamination by "Spring Kover", a flexible cover of elastomeric material. The use of HDS2 seals is recommended, where blind installations may increase the risk of spring displacement or the spring is subjected to dirt, water or other aggressive media.

HDS3: Heavy-duty seal with robust steel case equipped with adjustable spacer lugs. Body and sealing lip are made of XNBR, as standard. The stainless steel garter spring is mounted in a "Spring-Lock" groove and additionally protected against contamination by "Spring Kover".

Short information about permissible operating conditions is shown in the table on pages 28 and 29. For detailed technical data, recommendations about machining and installation as well as for information about available sizes, please refer to catalogue "SKF Industrial shaft seals" or the SKF website www.skf.com.



HDS1



HDS2



HDS3



Large diameter radial shaft seals

Seals with steel case



HDSA2 HDSA1

SKF heavy-duty seals in the HDSA, HDSB and HDSC series are designed with a robust steel case and an auxiliary wedge-shaped sealing lip and are intended for highly demanding sealing arrangements where axial space is insufficient for a second HDS seal. They are available on demand, optionally made of different materials.

- HDSA: Seal with one conventional sealing lip and a stainless steel garter spring, positioned in a "Spring-Lock" groove (HDSA1) or positioned in a "Spring-Lock" groove and additionally protected by "Spring Kover" (HDSA2), respectively. The straight face of the auxiliary seal lip is directed away from the primary sealing lip.
- HDSB: Same as HDSA design but the straight face of the auxiliary seal lip is directed towards the primary sealing lip.
- HDSC: Same as HDSA design but the auxiliary seal lip is arranged in front of the primary sealing lip.



HDSB2 HDSB1 HDSC2 HDSC1

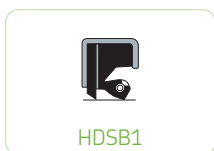

HDSB1

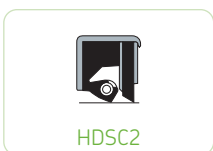

HDSC2



HDSD2 HDSD1

SKF heavy-duty seals in the HDSD and HDSE designs are equipped with two conventional sealing lips and provide highly efficient protection against liquids as well as coarse contaminations. These SKF heavy-duty seals with robust double steel case are available on demand, optionally made of different materials.

- HDSD: Seal with two sealing lips facing in opposite directions. The stainless steel garter springs are positioned in a "Spring-Lock" groove (HDSD1) or in a "Spring-Lock" groove and additionally protected by "Spring Kover" (HDSD2), respectively.
- HDSE: Same as the HDSD design but with two sealing lips arranged in tandem.

Note: When using an HDSD or an HDSE seal, it is very important to provide means to lubricate the sealing elements, i.e. the cavity between the sealing elements may be packed with grease or holes may be drilled from the outside diameter into the cavity between the lips.

Short information about permissible operating conditions is given in the table on pages 28 and 29. For detailed technical information and recommendations about machining and installation, please refer to catalogue "SKF Industrial shaft seals" or the SKF website www.skf.com.



HDSE2 HDSE1

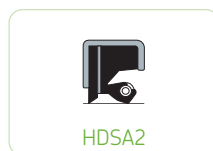

HDSA2

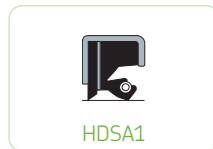

HDSA1

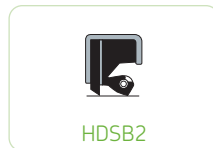

HDSB2

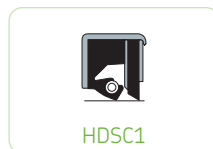

HDSC1



HDSE2



HDSE1



HDSD1



HDSD2

Fabric-reinforced seals



HSF1 HSF2

SKF large diameter radial shaft seals in the HSF series consist of a strong, flexible, fabric-reinforced rubber case, a conventional sealing lip made of nitrile rubber or fluoro rubber, preloaded by a stainless steel garter spring that is positioned in a "Spring-Lock" groove. These seals are available in solid as well as split design. They are intended for use in heavy-duty applications such as gear drives, propeller shafts, cold and hot rolling mills, pumps, pulp and paper machinery, etc.

- HSF1: Split heavy-duty seal with one conventional sealing lip
- HSF2: Split heavy-duty seal with one conventional sealing lip and lubrication grooves in the back face
- HSF3: Split heavy-duty seal with one conventional sealing lip a recessed back chamfer and lubrication grooves in the back face
- HSF4: Split heavy-duty seal with one conventional sealing lip and a contacting secondary (dust) lip.
- HSF5: As HSF1 seal but of solid design.
- HSF6: As HSF2 seal but of solid design.
- HSF7: As HSF3 seal but of solid design.
- HSF8: As HSF4 seal but of solid design.
- HSF9: Solid heavy-duty seal with a pressure profile sealing lip that withstands higher pressure differences across the seal than the other solid HSF designs.

Note: To attain optimum sealing performance, a retaining or end cover plate is necessary to properly install and apply all HSF seal types. The plate creates an axial preload that ensures reliable static sealing performance of the seal. The plate should also be designed to avoid seal distortion at assembly.

Short information about permissible operating conditions is given in the table on pages 30 and 31. For detailed technical data, recommendations about machining and installation as well as for information about available sizes, please refer to catalogue "SKF Industrial shaft seals" or the SKF website www.skf.com.



HSF3 HSF4



HSF5 HSF6 HSF7 HSF8 HSF9

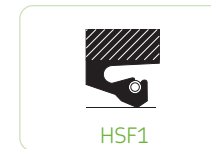

HSF1



HSF2



HSF3



HSF4

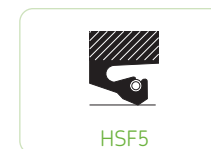

HSF5

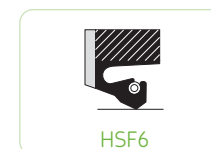

HSF6



HSF7

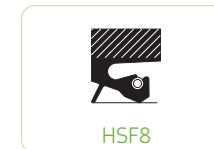

HSF8



HSF9

Large diameter radial shaft seals

Steel-reinforced, rubber covered seals



SBF

Large diameter seals in the SBF design have a rubber outside diameter, which is reinforced by a flexible ring or sheet steel that enables mounting without the use of a cover plate. The SBF seal can be used as an upgrade to fabric-reinforced seals in many applications, either they are grease or oil lubricated.

The SBF seals are equipped with a conventional sealing lip and a stainless steel garter spring that is positioned in a "Spring-Lock groove". They are available in both nitrile rubber and fluoro rubber.

Short information about permissible operating conditions is shown in the table on pages 30 and 31. For detailed technical data, recommendations about machining and installation as well as for information about available sizes, please refer to catalogue "SKF Industrial shaft seals" or the SKF website www.skf.com.



SBF



HDS4 HDS6

Steel-reinforced large diameter seals in the HDS4 and HDS6 series are made of nitrile rubber as standard and include a stiff L-type sheet steel reinforcement ring. Additionally they are equipped with moulded spacer lugs of 12,7 mm (0.5 in) length, which can be trimmed or removed if necessary.

- HDS4: Heavy-duty seal featuring a patented moulded-in garter spring which cannot be displaced even during difficult installations and provides superior oil sealing ability while minimizing wear.
- HDS6: Heavy-duty seal without garter spring designed for grease retention and contamination exclusion.

Short information about permissible operating conditions is shown in the table on pages 30 and 31. For detailed technical data, recommendations about machining and installation as well as for information about available sizes, please refer to catalogue "SKF Industrial shaft seals" or the SKF website www.skf.com.



HDS4



HDS6

All-rubber seals, solid or split



HS5

SKF all-rubber seals without reinforcement are equipped with a conventional sealing lip, preloaded by a stainless steel garter spring. Due to the wide application field of these seals the elastomeric body and sealing lip can be made of different materials. These SKF seals, designated by the series designation HS, are available in solid as well as split designs for shaft diameters of 200 mm (8 inch) and above. They must be axially clamped in the housing bore by an end cover.

Split seals are very economical solutions, where downtime is critical and shaft removal is impractical. These seals can simply be placed around the shaft and pushed into the housing bore. Split seals perform best with grease or other high viscosity fluids. They are also suitable for low viscosity fluids, provided that the seal is arranged vertically with the butt joint at the 12 o'clock position.

- HS3: Solid all-rubber seals with a spring-loaded conventional sealing lip. The stainless steel garter spring is held in an open groove. Recommended for vertical and horizontal shafts.
- HS4: Solid all-rubber seal with a spring-loaded conventional sealing lip. The stainless steel garter spring is retained in a "Spring-Lock" groove, which keeps it in position even under difficult installation conditions. Recommended for vertical and horizontal shafts.
- HS5: As HS4 seal but additionally protected by "Spring Kover", a flexible cover of elastomeric material.
- HS6: As HS4 seal but of split design.
- HS7: As HS5 seal but of split design. Very easy to install, but with less sealing efficiency.
- HS8: Split all-rubber seal with a spring-loaded conventional sealing lip. The stainless steel garter spring is retained in a "Spring-Lock" groove, additionally protected by "Spring Kover" and equipped with a special spring connector. Provides the best sealing efficiency of all split seals and is the preferred design for retaining low viscosity lubricants or excluding water when used on horizontal shafts.
- HS9: As HS3 seal but of split design. No longer recommended, should be superseded by HS8 seals.

Short information about permissible operating conditions is shown in the table on pages 30 and 31. For detailed technical data, recommendations about machining and installation as well as for information about available sizes, please refer to catalogue "SKF Industrial shaft seals" or the SKF website www.skf.com.



HS3 HS4



HS6 HS7



HS8 HS9



HS3



HS4



HS5



HS6



HS7





















HS8









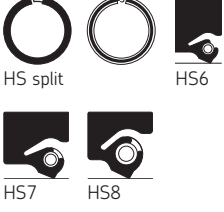

HS9

Large diameter radial shaft seals, permissible operating conditions for HDL, HDS and SBF seals

Standard design (preferred design)	Other basic designs	Material code	Operating temperature range		Pressure differential	Coaxiality	Runout (Dynamic eccentricity of shaft)	Maximum shaft surface speed	Ease of installation	Ability to seal low viscosity lubricants and exclude water
			°C	°F						
 HDS7	  HDS6 HDS4	R D H	-40 to +120 -55 to +105 -40 to +150	-40 to +250 -65 to +225 -40 to +300	0.1 (15)	1.6 (0.062)	2.4 (0.093)	25 (>5 000) depending on the operating conditions	Excellent	Highly effective exclusion of water and particle contamination and excellent retention of grease.
 HDL	 HDLA	R H V	-40 to +120 -40 to +150 -40 to +200	-40 to +250 -40 to +300 -40 to +400	0.1 (15)	2.5 (0.1)	2.4 (0.093)	24 (>5 000) 25 (>5 000) 35 (>7 000)	Good	Excellent, including retention of light oils at high surface speeds and misalignment.
 SBF		R V	-40 to +121 -40 to +204	-40 to +250 -40 to +400	0.1 (15)	1.5 (0.06)	2.4 (0.093)	25 (>5 000)	Excellent	Excellent for oil or grease retention.
 HDS2	  HDS1 HDS3	R D H V	-40 to +120 -55 to +105 -40 to +150 -40 to +205	-40 to +250 -65 to +225 -40 to +300 -40 to +400	0.1 (15)	1.6 (0.062)	2.4 (0.093)	25 (>5 000)	HDS2, HDS3: Excellent HDS1: Good	Excellent for oil or grease retention.
 HDSA2	     HDSA1 HDSB2 HDSB1 HDSC2 HDSC1	R D H V	-40 to +120 -55 to +105 -40 to +150 -40 to +205	-40 to +250 -65 to +225 -40 to +300 -40 to +400	0.1 (15)	1.6 (0.062)	2.4 (0.093)	25 (>5 000)	Excellent to good, varies with equipment design.	HDSA/B: Excellent for oil or grease retention with exclusion of light to moderate contamination. HDSC: Good grease retention, increased protection against contamination.
 HDSE2	   HDSE1 HDSD2 HDSD1	R D H V	-40 to +120 -55 to +105 -40 to +150 -40 to +205	-40 to +250 -65 to +225 -40 to +300 -40 to +400	0.1 (15)	1.6 (0.062)	2.4 (0.093)	25 (>5 000)	HDSD/SE2: Excellent HDSD/SE1: Good	HDSD: Excellent for oil or grease retention with exclusion of light to moderate contamination or separation of two media. HDSE: Good grease retention, increased protection against contamination.

Large diameter radial shaft seals, permissible operating conditions for HS and HSF seals

Standard design (preferred design)	Other basic designs	Material code	Operating temperature range		Pressure differential	Coaxiality	Runout (Dynamic eccentricity of shaft mm (inch)	Maximum shaft surface speed	Ease of installation	Ability to seal low viscosity lubricants and exclude water
			°C	°F						
 HS solid HS5	 HS3 HS4	R D H V	-40 to +120 -55 to +105 -40 to +150 -40 to +205	-40 to +250 -65 to +225 -40 to +300 -40 to +400	HS3: 0.03 (5) HS4: 0.07 (11) HS4: 0.07 (11)	1.6 (0.062)	2.4 (0.093)	HS3: 10 (2 000) HS4: 15 (3 000) HS5: 13 (2 500)	HS3: Fair HS4: Good HS5: Good	HS3: Fair HS4: Good HS5: Good
 HS split HS6 HS7 HS8	 HS9	R D H V	-40 to +120 -55 to +105 -40 to +150 -40 to +205	-40 to +250 -65 to +225 -40 to +300 -40 to +400	0	1.6 (0.062)	2.4 (0.093)	HS6: 10 (2 000) HS7: 7.5 (1 500) HS8: 10 (2 000) HS9: 7.5 (1 500)	HS6: Fair HS6: Excellent HS6: Good HS9: Fair	HS6, HS8: Good to excellent for oil or grease retention HS7: Good (grease only) HS9: Fair to good
 HSF Solid HSF5	 HSF6 HSF7 HSF8 HSF9	R V	-40 to +120 -40 to +205	-40 to +250 -40 to +400	0.03 (5)	1.5 (0.06)	2.4 (0.093)	15 (>3 000) depending on the operating conditions	Good to excellent	Excellent
 HSF split HSF1	 HSF2 HSF3 HSF4	R V	-40 to +120 -40 to +205	-40 to +250 -40 to +400	0	1.5 (0.06)	2.4 (0.093)	15.2 (>3 000) depending on the operating conditions	Fair to good depending on the available space for mounting	Good to excellent

Radial shaft seals

Cassette seals and shaft sealing units



Cassette seals and sealing units are intended for the use in heavy-duty applications such as off-road vehicles, agricultural or similar construction machinery where environmental and operating conditions are harsh. These seals represent an increase in the complexity of sealing technology, compared with standard sealing design.



The geometry of the cassette seals provides optimised protection against water, dust, and mud and other heavy contaminants. This improved protection is the result of the special radial and axial sealing lips, unitised with axial and radial wear sleeves. Cassette seals also eliminate the need to carry out shaft machining during replacement.

SKF cassette seals and sealing units are tailored to the customer's specific assembly requirements as well as for the specific operating conditions.



Cassette seals and shaft sealing units

The MudBlock cassette seals



MUD1 MUD2

MudBlock cassette seals are a new generation of radial shaft sealing units specifically developed for heavy-duty applications in harsh environmental and at difficult operating conditions.

SKF MudBlock cassette seals are customized sealing solutions:

- with or without spring-loaded primary sealing lip
- with one or more secondary sealing lips
- with or without shaft wear sleeves
- with or without rubber covered outside surfaces

and can be made from a variety of elastomeric materials, including nitrile rubber (NBR), polyacrylate elastomer (ACM), fluoro rubber (FKM) or other elastomeric compounds.

The geometry of MudBlock cassette seals has been altered to provide excellent retention of either grease or oil and optimum protection against water and mud ingress.

SKF MudBlock cassette seals are manufactured on demand. For more detailed information about technical data, size range and additional recommendations, please contact your local SKF representative.



MUD3 MUD4 MUD5 MUD6 MUD7

The Scotseal® sealing units



MUD1



MUD2



MUD3



MUD4



MUD5

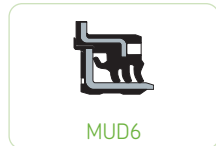

MUD6



MUD7



SCOTSEAL CLASSIC



SCOTSEAL LONGLIFE



SCOTSEAL PLUS XL

Scotseal sealing units are customized sealing elements for lubricant retention and dirt exclusion in hub bearing arrangements, mainly for axles of commercial and off-road vehicles and in gearboxes or differentials. These sealing units are available in three different executions:

- Scotseal Classic: Unitized, one-piece design sealing unit with one primary, spring-loaded sealing lip and two secondary sealing lips of nitrile rubber (NBR), which rotate with the shaft and seal against the inner diameter of the metallic case. This case has a Bore-Tite coated outer diameter and protects the sealing lips from being damaged during one-step mounting. Scotseal Classic sealing units are proven and economical solutions for heavy-duty automotive applications.
- Scotseal Longlife: Unitized, one-piece design sealing unit with one primary, spring-loaded sealing lip and three secondary sealing lips of hydrogenated nitrile rubber (HNBR), which rotate with the shaft and seal against the inner diameter of the metallic case. This case has a Bore-Tite coated outer diameter and protects the sealing lips from being damaged during one-step mounting. Scotseal Longlife sealing units are robust solutions with excellent synthetic lubricant retention properties and high resistance to dirt ingress even at high temperatures.
- Scotseal Plus XL: The most advanced design of Scotseal sealing units. Unitized, one-piece seal with one primary spring-loaded sealing lip and three secondary contacting sealing lips of hydrogenated nitrile rubber (HNBR), which rotate with the housing. The outer diameter of the metallic case and the bore diameter of the seal counter face are coated with rubber. Scotseal Plus XL sealing units are robust solutions with excellent synthetic lubricant retention properties and high resistance to dirt ingress even at high temperatures. They enable easy mounting and require no installation tool.

For more detailed information about technical data or size range, please contact your local SKF representative.

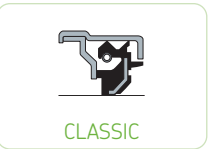
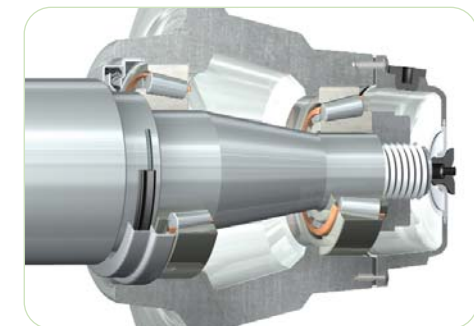

CLASSIC



LONGLIFE



PLUS XL

Other SKF radial shaft seal designs

SKF produces a large range of radial shaft seals in special designs. This is a selection from this range, applied in general industry worldwide. In case of demand for any of these designs, your SKF sales representative can give you more information about technical data and availability.

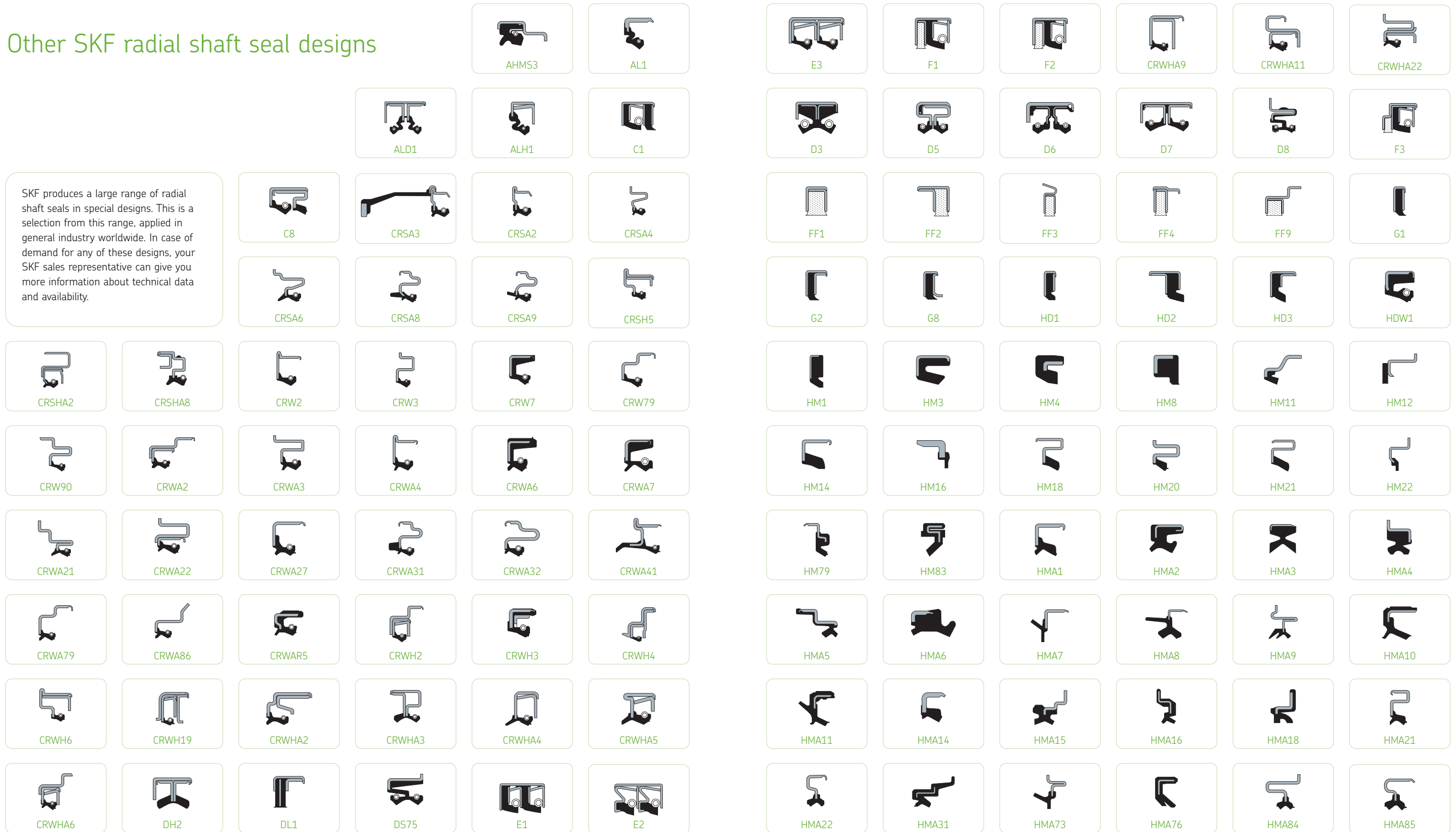

Other SKF radial shaft seal designs

SKF produces a large range of radial shaft seals in special designs. This is a selection from this range, applied in general industry worldwide. In case of demand for any of these designs, your SKF sales representative can give you more information about technical data and availability.

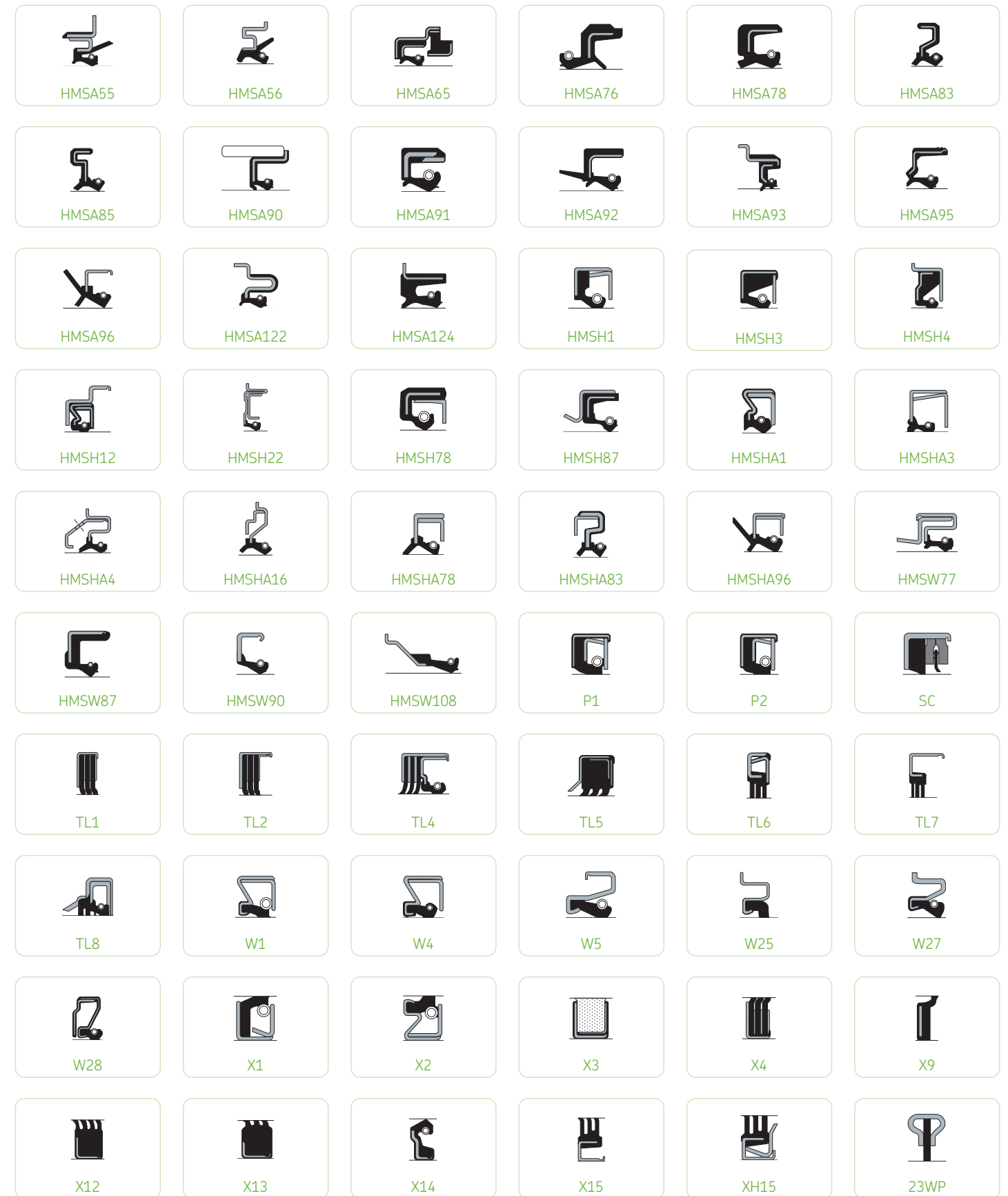



Wear sleeves



Speedi-Sleeve Gold



For radial shaft seals to perform efficiently, the condition of the counter face, i.e. shaft surface, is of significant importance. If the counter face is worn or damaged, the seals will no longer be able to fulfil their function; to retain lubricant and to exclude contaminants.

The SKF wear sleeves have been developed to solve the problem of worn seal counter faces at shaft ends and offer the possibility to repair these shafts the easy way. They are simply pushed over the damaged surface enabling the shaft to be re-used within minutes and at a fraction of the cost of traditional reworking. Depending on size, SKF wear sleeves are available in two different designs.

- Speedi-Sleeve: Very thin-walled wear sleeve, which allows the same size of seal to be used as the original one. The range of SKF Speedi-Sleeves comprises the standard Speedi-Sleeve for normal operating conditions and the Speedi-Sleeve Gold for harsh operating conditions. They are available for shaft diameters up to 200 mm or 8 inch respectively.
- LDSLV: Wear sleeves for shaft diameters above 200 mm (8 inch) up to approximately 1 150 mm (45 inch) with 2,4 mm wall thickness. Two designs are available on demand; the LDSLV3 sleeve with a flange and the flangeless LDSLV4 sleeve.

Detailed information about technical data, size range and recommendations about machining and installation can be found in catalogue "SKF Industrial shaft seals", in the product brochure "SPEEDI-SLEEVE®" or on the SKF website www.skf.com.



LDSLV3



LDSLV4



Axial shaft seals

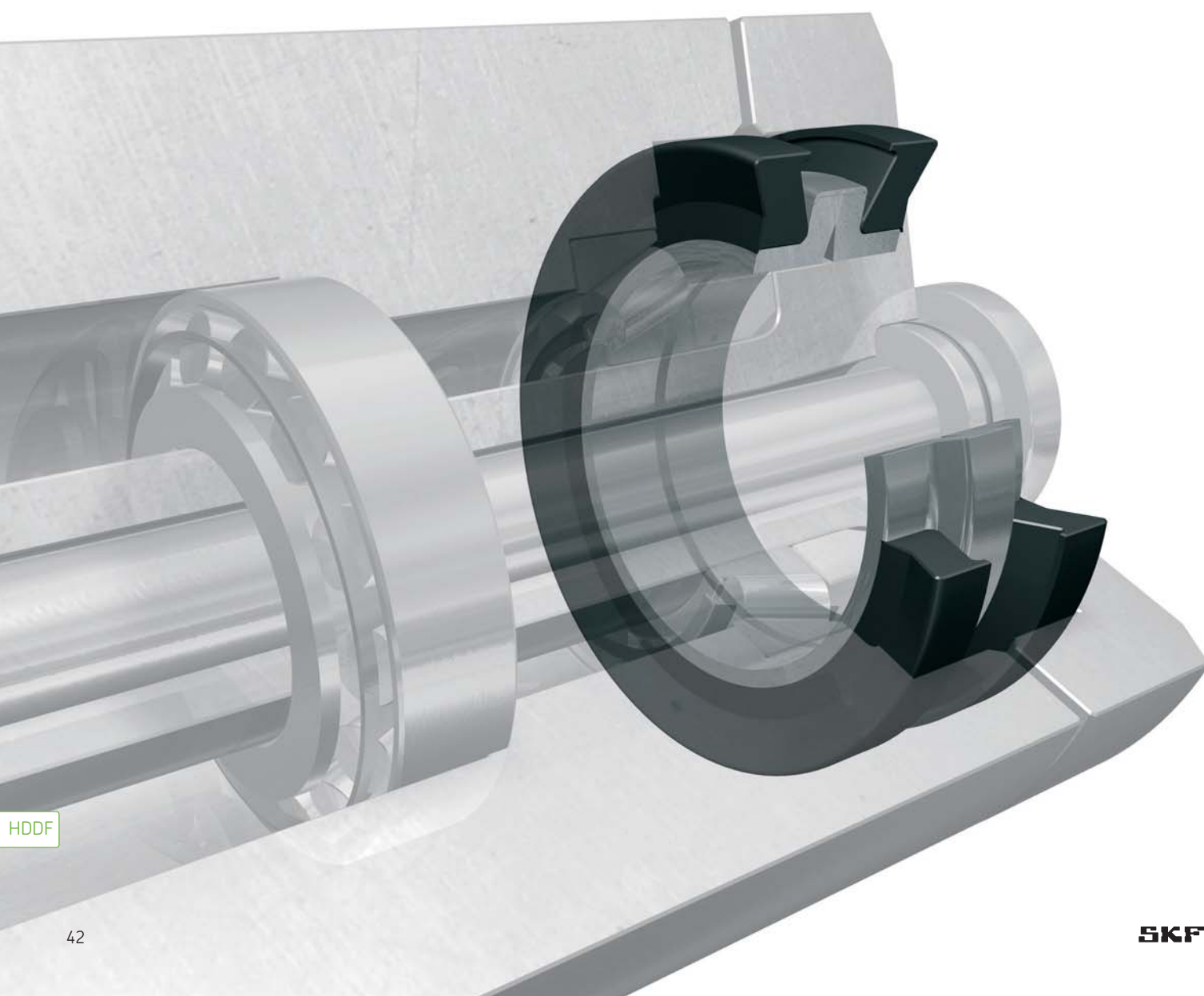

VR4



CT4



MVR1

Axial shaft seals are simple sealing elements and specifically suitable as secondary seals in applications where otherwise the primary contacting or non-contacting seals would be subjected to excessive quantities of contaminants.

Axial shaft seals are available from SKF as:

- V-rings
- Metal-clad V-type sealing rings and axial clamp seals
- Mechanical seals

With the exception of axial clamp seals, axial shaft seals rotate with the shaft and act as flingers. They tolerate small misalignments of the shaft with respect to the counter face and also provide reliable sealing if the shaft is out of round or rotates eccentrically.



V-ring seals

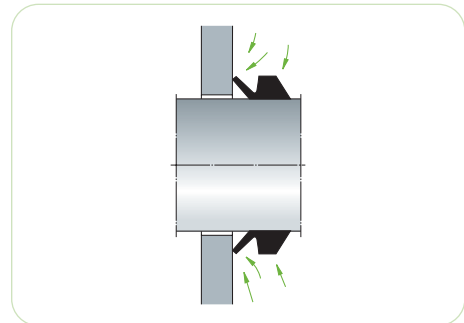

V-ring seals are unique all-rubber seals for rotary shafts. They are made entirely of rubber material and comprise a body and a conical shaped sealing lip, which is joined to the body by means of a resilient "hinge".

V-rings are mounted on and rotate with the shaft. The lip seals axially against a counter face, which is perpendicular to the shaft. The body has an interference fit on the shaft and holds the lip in position. V-rings can be stretched out and fitted over a flange during installation, which is a very valuable characteristic, especially in the case of repair. They can operate at sliding velocities up to 8 m/s. At velocities above 8 up to 12 m/s the V-rings need to be axially located.

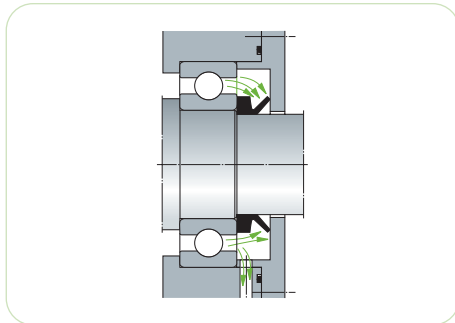
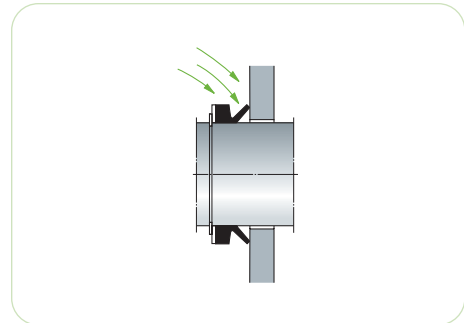
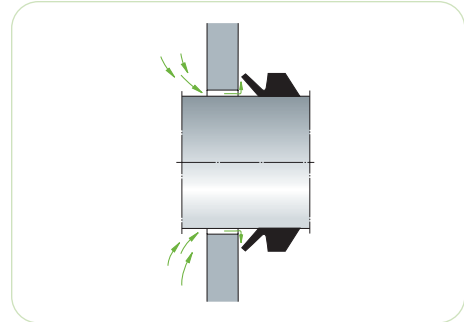

V-ring seals are available in a large variety of designs and sizes to fit the requirements of most applications. V-rings are normally made of nitrile rubber. For applications where higher temperatures occur or where aggressive media are present, V-rings made of fluoro rubber should be used.

Series VR



V-ring seals are available in four standard designs and two large size heavy-duty designs.

- VR1 design: Most common V-ring with normal cross section and straight backside face. Available from stock for shaft diameters from 2,7 up to 2 020 mm (0.11 up to 80 inch).
- VR2 design: V-ring with normal low cross section and a tapered back face but wide body, providing a very firm hold on the shaft. Available from stock for the most commonly used shaft diameters, which range from 4,5 to 210 mm (0.18 to 8.3 inch).
- VR3 design: Narrow low-section V-ring intended for the use in compact sealing arrangements or labyrinth seals. Available from stock for shaft diameters in the range from 135 up to 630 mm (5.3 up to 25 inch).
- VR4 design: Wide high-section V-ring designed as a secondary seal for heavy-duty applications where the primary seal has to be protected against water and/or solid contaminants. It permits the largest axial displacements. Available from stock in the diameter range from 450 up to 2 010 mm (17.7 to 80 inch).
- VR5 design: Wide low-section heavy-duty large diameter V-ring, which can be axially located on the shaft using a standard clamping band. Primarily intended for large, high-speed applications, like rolling mills and paper mills. Detailed information on request.
- VR6 design: Heavy-duty large diameter V-ring for extended axial displacements, which can be axially located on the shaft using a standard clamping band. Primarily intended for large, high-speed applications, like rolling mills and paper mills. Detailed information on request.

Detailed information about V-rings in the VR1, VR2, VR3 and VR4 designs and about technical data, size range and installation can be found in catalogue "SKF Industrial shaft seals" or on the SKF website www.skf.com.

Design	VR1	VR2	VR3	VR4	VR5	VR6
min [mm]	2,7	4,5	135	450	300	300
max [mm]	2 020	210	630	2 010	2 010	2 010



Metal-clad V-type sealing rings and axial clamp seals

Series MVR and CT



MVR1 MVR2

Metal-clad V-type sealing rings act as flingers and protect primary seals against coarse contaminants, dust and water spray, which considerably extends reliability and service life of sealing arrangements.

MVR metal-clad V-type sealing rings from SKF consist of a metal case, which house a body and a conical shaped axial sealing lip of nitrile rubber. The corrosion-resistant metal case protects the elastomeric sealing lip against mechanical effects from the outside. The seal has a tight fit on its seating and withstands speeds up to 12 m/s without auxiliary clamping devices.

MVR metal-clad V-type sealing rings are available for shaft diameters from 10 to 200 mm and can be used at temperatures between -30 and +100°C.

Detailed information about technical data, size range and recommendations about machining and installation can be found in catalogue "SKF Industrial shaft seals" or on the SKF website www.skf.com.



CT1 CT3

SKF axial clamp seals are designed for large and very large diameters. They do not rotate but seal axially against a rotating counter face.

These CT design axial clamp seals are made of appropriately profiled strips of non-reinforced nitrile rubber (NBR) and are held firmly in position by stainless steel screw-type clamps. Axial clamp seals are available in the diameter range from 150 up to 4 600 mm (6 up to 181 inch) and are produced in three different designs:

- CT1: Axial clamp seal with a flat face axial sealing lip. It permits an axial displacement with respect to the counter face of +2,4 mm.
- CT3: Axial clamp seal with a flat face axial sealing lip but provided with annular grooves. These grooves serve to trap contaminants, which may have started to penetrate the lip/counter face contact. CT3 axial clamp seals permit an axial displacement with respect to the counter face of +4,8 mm.
- CT4: Axial clamp seal with flat sealing lip as for the CT1 design, but with an extra wide body, which has to held in position by two clamps. It permits an axial displacement with respect to the counter face of +4,8 mm.



CT4

Detailed information about technical data, size range and recommendations about machining and installation can be found in catalogue "SKF Industrial shaft seals" or on the SKF website www.skf.com.



MVR1



MVR2



CT1



CT3



CT4

Mechanical seals

Series HDDF



HDDF1

Mechanical seals are designed for use under severe service conditions at relatively low peripheral speeds. They offer reliable protection against solid and liquid contaminants as well as leak-proof retention of lubricants. These seals were originally developed for off-road vehicles but have been found to be equally suitable for a range of other applications where effective protection is required against sand, soil, mud, water etc.

SKF mechanical seals carry the series designation HDDF and consist of two identical sealing rings and two similar Belleville washers (cup springs). The sealing rings are made of wear and corrosion resistant steel and have finely finished sliding and sealing surfaces. The Belleville washers of nitrile rubber provide the necessary uniform face loading and positive sealing at the bore and outside diameters.

HDDF mechanical seals are available from 44 up to 1 616 bore diameter can be used at temperatures between -30 and +100°C and pressure differentials up to 0,2 MPa. The permissible velocity at continuous operation is up to 1,75 m/s and up to 4 m/s at brief periods.

Detailed information about technical data, size range and recommendations about machining and installation can be found in catalogue "SKF Industrial shaft seals" or on the SKF website www.skf.com.



HDDF1

Permissible operating conditions

Operating conditions	Guideline values
Operating temperature, °C (°F)	
continuous operation	-50 to +100 (-60 to +210)
brief periods, maximum	+120 (+250)
Peripheral speed, m/s (ft/min)	
continuous operation	up to 1,75 (345)
brief periods, maximum	up to 4 (790)
Pressure acting on seal, MPa (psi)	
continuous operation	up to 0,2 (30)
brief periods, maximum	up to 0,35 (50)

Hydraulic seals

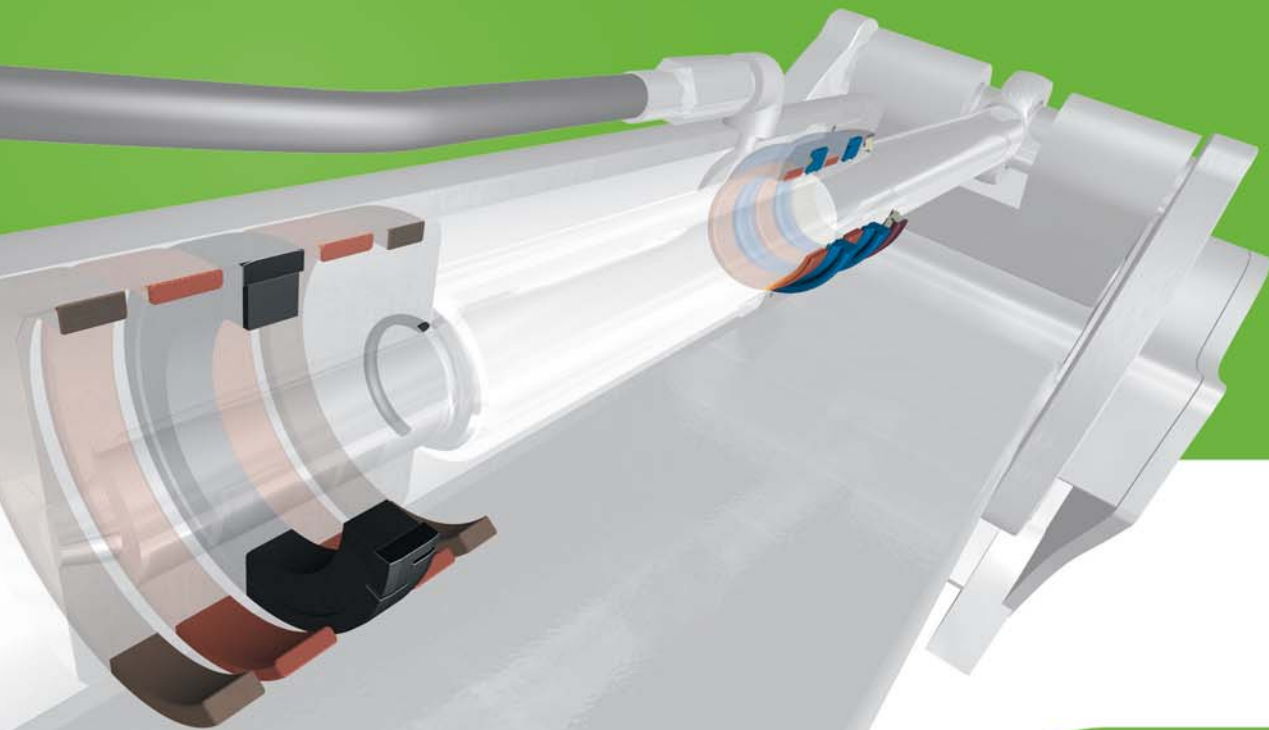

Hydraulic sealing system



The main tasks of hydraulic seals are to retain hydraulic fluids, to exclude solid or liquid contaminations and to maintain the hydraulic pressure. These tasks require a variety of different seal designs and appropriate accessories. To match all individual application requirements the SKF range of hydraulic seals comprises:

- Piston seals
- Rod seals
- Wiper seals
- Guide rings and guide strips

Hydraulic cylinders also require static sealing solutions including O-rings and most often back-up rings.

Comprehensive technical product data can be found in our technical catalogue, "SKF Hydraulic seals".

Besides hydraulic seals SKF also manufactures components for the use in pneumatic cylinders. For additional information about these products, please contact your local SKF representative.

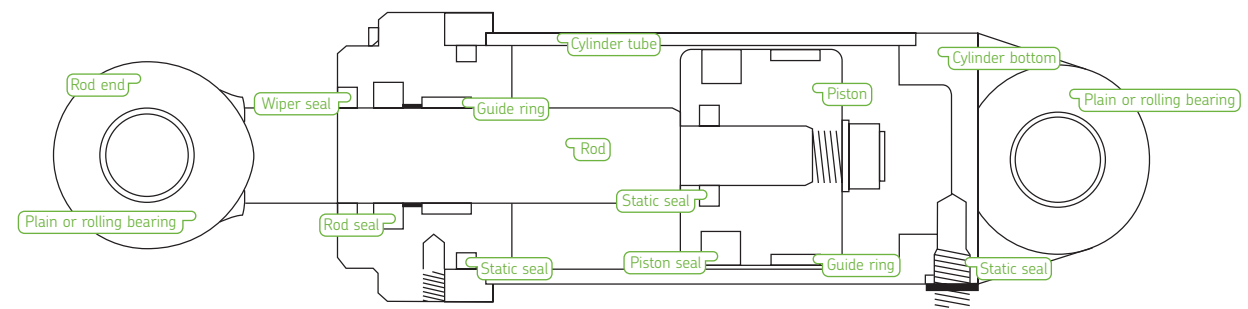

Hydraulic cylinder - Terminology

Hydraulic seals

Material overview



CUT, GH, SIL, GR, PA, GA, SB, SCB



In addition to seal design, the seal material significantly contributes to seal performance and reliability. To cater for the different demands of applications, SKF seals are produced in a variety of materials, see list below. These materials have characteristics, individual properties, making them particularly suitable for specific applications.

Codes are used to identify the seal material of SKF seals and are listed in the table below. The codes also appear in some seal designations.

Details about physical properties and the chemical resistance of the seal materials to various hydraulic fluids encountered in operation can be provided by your SKF representative.

SKF hydraulic seal materials

Composition of basic material	Designation according to		Nominal operating temperature range
	SKF	ISO / ASTM	
Acrylonitrile-butadiene rubber (nitrile rubber)	N	NBR	-50 to +100°C (-60 to +210°F)
Hydrogenated acrylonitrile-butadiene rubber	HN	HNBR	-30 to +150°C (-20 to +300°F)
Fluoro rubber	F	FKM	-40 to +200°C (-40 to +390°F)
Polytetrafluoroethylene	PTFE	PTFE	-200 to +260°C (-330 to +500°F)
Polyurethane	PUR	PUR	-40 to +110°C (-40 to +230°F)
Phenolic/fabric	PF	PF	-60 to +130°C (-80 to +270°F)
Acetal resin	A	POM	-30 to +100°C (-20 to +210°F)

Hydraulic seals

Piston seals

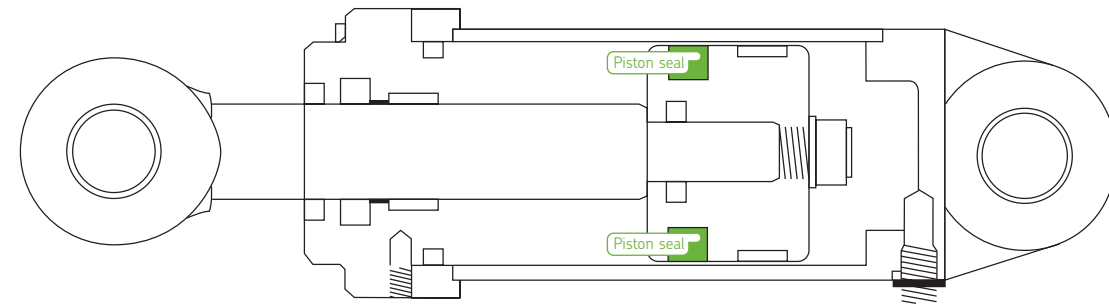
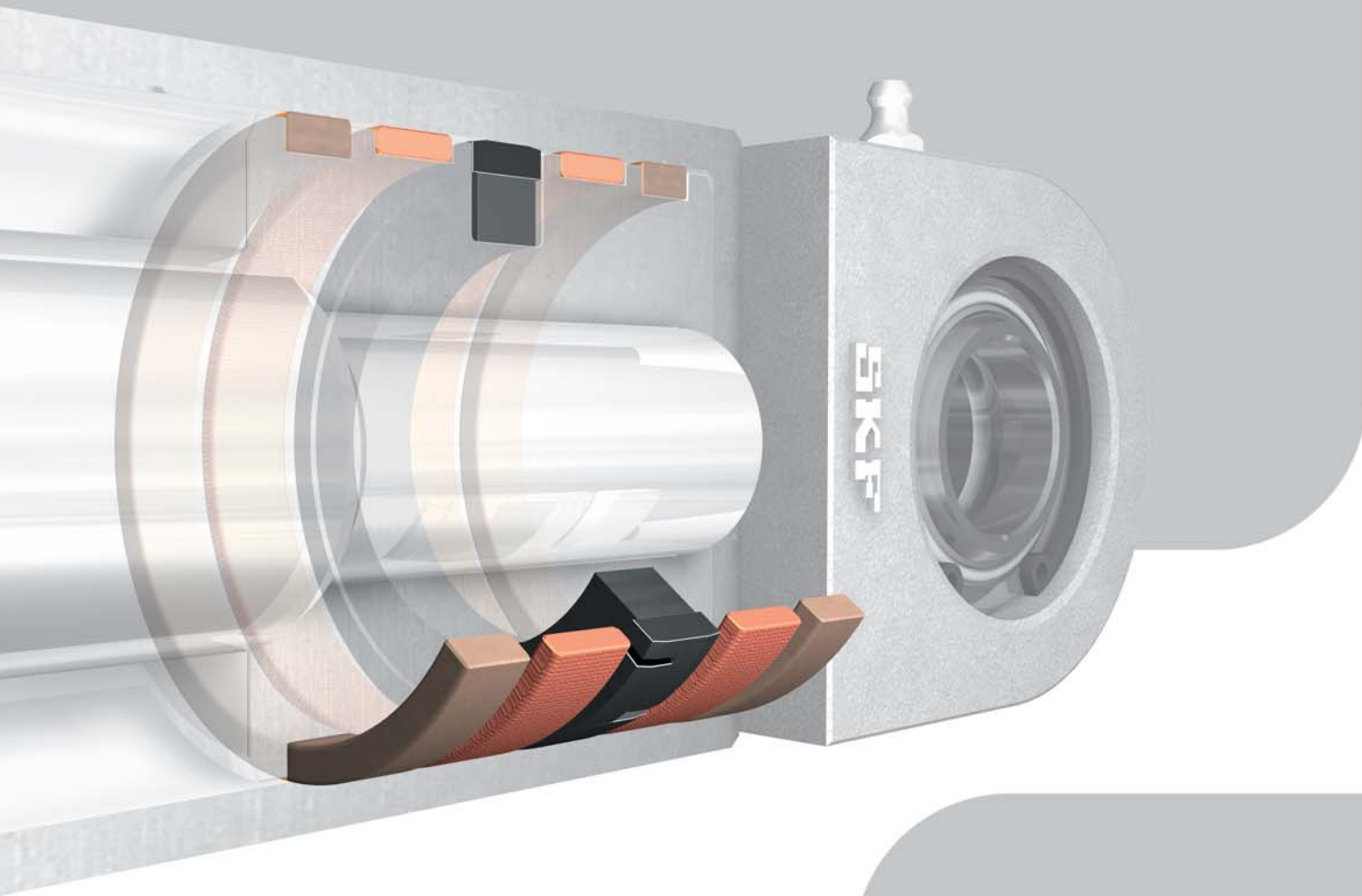

The basic demand on piston seals for hydraulic cylinders under the operating conditions, for which they have been chosen, is to maintain a high level of sealing performance during their service life.

The choice of the type of piston seal is to a great extent depending on the way in which the cylinder operates, i.e. in single-acting or double-acting operations. For a cylinder, which is exclusively single-acting, it is always best to choose the type of seal designed to provide optimum sealing qualities for single-acting functions with e.g. the thinnest possible lubrication film that can pass through the contact area between the seal and the cylinder tube surface.

The best sealing capacity of a double-acting cylinder is achieved by choosing a double-acting seal. A piston design where two single-acting seals on the piston for a double-acting cylinder are used can easily give rise to a breakdown. The reason is that a very high pressure can be trapped between the seals.

In this publication, we present our range for both single- and double-acting piston seals with their main design features and operating condition areas. For comprehensive technical data and recommendations about the right choice of seal, as well as for information about machining and installation, please see our technical catalogue, "SKF Hydraulic seals".



Piston seals

Double-acting piston seals

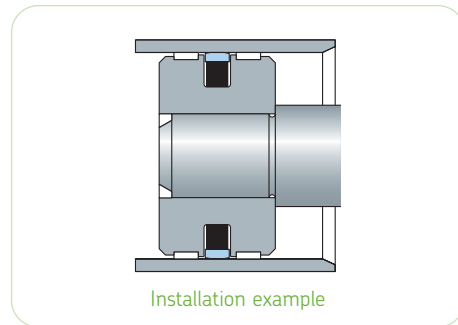

SKF double-acting piston seals type CUT consist of a step cut slide ring of polyamide (PA) and a rectangular energizer of nitrile rubber (NBR). The material of the slide ring provides low friction even at high pressure and is very wear and extrusion resistant. The design with a cut slide ring provides a very simple assembly into a closed housing groove. The energizer offers an excellent static sealing ability in the seal housing groove.

Type CUT is designed for use in heavy-duty hydraulic applications, mainly in double-acting cylinders with pressures up to 50 MPa (short-term 100 MPa) also at radial clearances of up to 0,5 mm. Type CUT is also available in a specific material combination withstanding even tougher operating conditions.

The piston seal set type CUT has a range of advantages, providing users added value:

- fits in existing housing designs according to ISO 7425-1
- only two parts to mount
- equilateral – cannot be mounted in wrong direction
- split – no tool required
- excellent in biodegradable oils

Detailed information about technical data, size range and installation can be found in catalogue “SKF Hydraulic seals” or on the SKF website www.skf.com.

Seal type	Seal material	Maximum pressure MPa psi	Maximum linear velocity m/s ft/min	Temperature range °C °F
CUT	PA, NBR	50 7 250	1 200	-30 / +110 -20 / +230

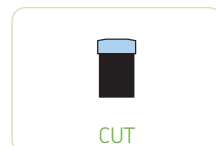

GHT-MD1



GHT-ND6

Double-acting piston seals in the GHT series are four-piece seals consisting of a central slide ring, two support rings and one energizer. They are intended for use in hydraulic cylinders for medium and heavy-duty applications and are available in different material combinations to meet varying demands.

- GHT-MD1: Piston seal with a slide ring made of a filled PTFE material, two support rings of acetal resin (POM) and one energizer of nitrile rubber (NBR). It withstands temperatures between -30°C and +100°C (-20°F and +210°F) at pressures up to 40 MPa (5 800 psi).
- GHT-ND6: Piston seal consisting of a slide ring made of a filled PTFE material, two support rings of polyamide (PA) and one energizer of hydrogenated nitrile rubber (HNBR). It withstands temperatures between -30°C and +130°C (-20°F and +270°F) at pressures up to 40 MPa (5 800 psi).

Detailed information about technical data, size range and installation can be found in catalogue “SKF Hydraulic seals” or on the SKF website www.skf.com.

Seal type	Seal material	Maximum pressure MPa psi	Maximum linear velocity m/s ft/min	Temperature range °C °F
GHT-MD1	PTFE NBR, POM	40 5 800	2 395	-30 / +100 -20 / +210
GHT-ND6	PTFE PA, HNBR	40 5 800	2 395	-30 / +130 -20 / +270

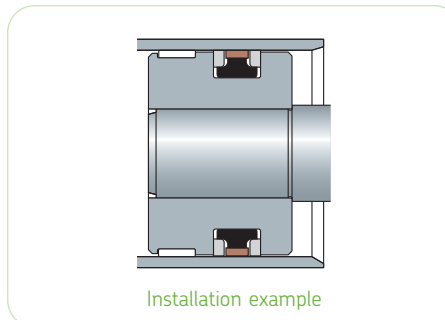

GHT-ND6



GHT-MD1

Piston seals

Double-acting piston seals



URG

Type URG is a double-acting piston seal consisting of a slide ring of polyurethane and a square cut energizer of nitrile rubber. The slide ring has chamfered sealing edges to obtain optimal tightness and resistance to extrusion. Its notches in the radial face enable rapid reaction to changes in the pressure direction.

Type URG is designed for medium-duty applications, e.g. earth-moving equipment, agricultural machinery and loading cranes.

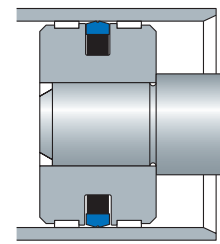

Installation example

Seal type	Seal material	Maximum pressure MPa psi	Maximum linear velocity m/s ft/min	Temperature range °C °F
URG	PUR, NBR	25 3 625	0,5 100	-30 / +90 -20 / +195



URG



M

Double-acting piston seals in the M series are five-piece seals of symmetrical design, consisting of a central sealing ring of nitrile rubber, support rings of a polyester elastomer and well integrated guide rings of acetal resin.

Type M is the most common design with L-shaped guide rings and a smooth contact sealing surface profile providing a good lubrication film. The central sealing ring of type MD has three sealing edges resulting in a thinner lubrication film. Type MD is appropriate in applications where a double-acting cylinder is used as a single-acting with one side of the piston connected to the air. Both types are used in light- and medium-duty hydraulic applications (up to 25 MPa).

The shape of the guide rings of type M-R makes it possible to produce them with close tolerances and in a phenolic/fabric material that is suitable in applications with high temperatures and heavy side loads. Type M-R withstands pressures up to 28 MPa.



MD



M-R

Seal type	Seal material	Maximum pressure MPa psi	Maximum linear velocity m/s ft/min	Temperature range °C °F
M	NBR, POM	25 3 625	0,5 100	-30 / +100 -20 / +210
MD	NBR, POM	25 3 625	0,5 100	-30 / +100 -20 / +210
M-R	NBR, POM	28 4 060	0,5 100	-30 / +100 -20 / +210



M



MD



M-R

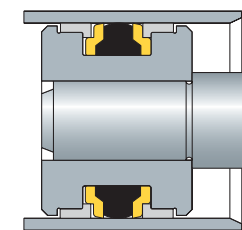

Installation example

Piston seals

Series G and GL



GH

All types of series G and GL consist of a dynamically sealing slide ring of PTFE or other thermo-plastic materials and a static, elastomeric part, which also functions as an interference element. They are available in different designs and material combinations, all to meet demands on low friction, small housing dimensions and a long service life. Main difference between series G and GL is the slightly lower section of the slide ring of series GL. The basic design of series GL is made of unfilled PTFE, while the basic design of series G is made of a bronze-filled PTFE compound.

The following table gives a first indication about the right choice of type for different application demands. Comprehensive technical data and selection criteria can be found in catalogue, "SKF Hydraulic seals".



GR

GN

Seal type	Seal material	Maximum pressure MPa psi	Maximum linear velocity m/s ft/min	Temperature range °C °F
GL, GLC, GLG	PTFE, NBR	16 (160) 2 320	2 395	-30 / +110 -20 / +230
GC, G, GG, GN, GS, GH-XX8, GH, GR	PTFE, NBR	25 (290) 3 625	2 395	-30 / +110 -20 / +230



GS

GC

GG

GH-XX8

G

GL

GLC

GLG

Features and field of application of SKF slide ring seals

GH	Basic design, double-acting, chamfered edges at the dynamic outside diameter to reduce the risk of extrusion, notches to avoid pressure build-up between slide ring and energizer.
G, GL	Double-acting, sharp edges at the dynamic outside diameter and recommended for the use in light- or medium-duty hydraulic cylinders, where impure media may occur.
GC, GLC	Double-acting, chamfered edges at the dynamic outside diameter to reduce the risk of extrusion.
GG, GLG	Double-acting, sharp edges at the dynamic outside diameter and a groove in the sliding surface for improved sealing ability.
GH-XX8	Double-acting, square cut energizer providing reduced pressure against the dynamic surface and increased static sealing ability.
GN	Double-acting, notches in both side faces, recommended for cylinders with rapid pressure changes
GR	Double-acting, chamfered edges at the dynamic outside diameter, a groove in the sealing surface and notches in both side faces. Additionally the slide ring has a radius on the static side for optimal function together with the O-ring type energizer. Recommended for applications where additional rotating or slewing movements may occur.
GS	Single-acting, recommended for applications with high demands on sealing ability



GH



GR



GN

Choice of material

Medium	Material contact surface	Slide ring material	O-ring material
Hydraulic oil Lubrication oil (mineral oil based)	Steel: min 33 HRC Chromed surface, cast iron	1) PTFE + bronze 2) PTFE + glass fibre 3) PE-UHMW	NBR NBR NBR
	Stainless steel, aluminium, anodized or chromed bronze	1) PTFE + carbon 2) PTFE + carbon fibre 3) PE-UHMW	F F F
Water Water/glycol	Steel: min 33 HRC Chromed surface, cast iron,	1) PTFE + carbon 2) PTFE + carbon fibre	NBR F E
	stainless steel, aluminium, anodized or chromed bronze	3) PTFE + carbon 4) PE-UHMW	NBR F
Water/oil emulsion Hot water/steam	Steel: min 33 HRC Chromed surface, cast iron, stainless steel, aluminium, anodized or chromed bronze	1) PTFE + carbon 2) PTFE + carbon fibre 3) PTFE + carbon	E E E
	Steel: min 33 HRC Chromed surface, cast iron	1) PE-UHMW 2) PTFE + glass fibre 3) PTFE + low-filled + colour pigment, only lubricated service	NBR NBR NBR
Air, lubricated service Air, non-lubricated service	Stainless steel, aluminium, anodized or chromed bronze	1) PE-UHMW 2) PTFE + carbon 3) PTFE + carbon fibre 4) PTFE + carbon	NBR NBR NBR NBR

More information on choice of material combinations can be found in our catalogue "SKF Hydraulic seals".



GS



GC



GL



GG



GLC



GH-XX8



GLG



G

Piston seals

Double-acting piston seals



A

Type A is a double-acting, compact piston seal consisting of a central sealing ring of nitrile rubber, two support rings of a polyester elastomer and two integrated guide rings of acetal resin.

Suitable for medium- and heavy-duty hydraulic cylinders in earth-moving equipment, agricultural machinery and standard cylinders, mostly as spare part for older hydraulic equipment.

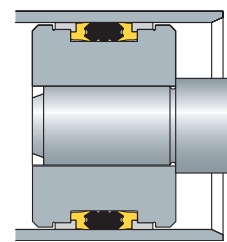

Installation example

Seal type	Seal material	Maximum pressure MPa psi	Maximum linear velocity m/s ft/min	Temperature range °C °F
A	NBR, POM	40 5 800	0,5 100	-30 / +100 -20 / +210



A

Single-acting piston seals



SAARR

Type SAARR is a single-acting piston seal, consisting of an asymmetric U-ring seal of polyetherurethane, an integrated support ring of acetal resin and a retainer ring of acetal resin.

Type SAARR is the most effective seal for pistons in single-acting cylinders, also in cold conditions thanks to the polyetherurethane. Example of applications are earthmoving equipment and agricultural machinery.

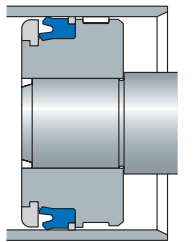

Installation example

Seal type	Seal material	Maximum pressure MPa psi	Maximum linear velocity m/s ft/min	Temperature range °C °F
SAARR	PUR, POM	25 3 625	0,5 100	-30 / +90 -20 / +195



SAARR



SA

Type SA and SAW are single-acting, asymmetric U-ring seals of polyetherurethane. Type SAW has an integrated guide ring of acetal resin.

Both types are used in e.g. earthmoving equipment, support cylinders and presses.

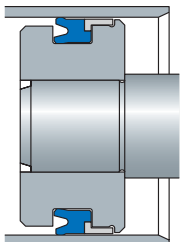

Installation example

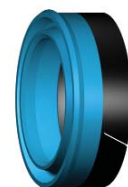

SAW

Seal type	Seal material	Maximum pressure MPa psi	Maximum linear velocity m/s ft/min	Temperature range °C °F
SA	PUR	25 3 625	0,5 100	-30 / +90 -20 / +195
SAW	PUR, POM	25 3 625	0,5 100	-30 / +90 -20 / +195



SA



SAW

Piston seals

Single-acting piston seals



SWRR

Type SWRR consists of a compact sealing ring of nitrile rubber with fabric reinforcement, an integrated support ring of acetal resin and a retainer ring of acetal resin.

Type SWRR is designed for use in single-acting cylinders with medium pressure operations.

Seal type	Seal material	Maximum pressure MPa psi	Maximum linear velocity m/s ft/min	Temperature range °C °F
SWRR	NBR, POM	25 3 625	0,5 100	-30 / +100 -20 / +210



SWRR

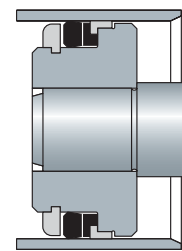

Installation example

Spring activated piston seals



SUA

Seals of series SU are single-acting PTFE seals, preloaded by springs of stainless steel. They are used as dynamic seals at slowly rotating or reciprocating movements or as static seals.

Seals of series SU often replace a rubber seal, e.g. an O-ring, in applications with very high or low temperatures, non-lubricated services, demands on low friction, aggressive media, high speeds, high pressures, vacuum etc. Series SU can be delivered with many different spring types and materials adjusted to the application demands. The most commonly used types are:

- SUA: asymmetrical design with a wiper lip
- SUD: asymmetrical design with a strong dynamic lip
- SUS: symmetrical design for static applications

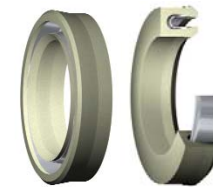

SUD

SUS

Seal type	Seal material	Maximum pressure MPa psi	Maximum linear velocity m/s ft/min	Temperature range °C °F
SUA	PTFE + Stainless steel	25 3 625	15 2950	-200 / +260 -330 / +500
SUD	PTFE + Stainless steel	25 3 625	15 2950	-200 / +260 -330 / +500
SUS	PTFE + Stainless steel	25 3 625	- -	-200 / +260 -330 / +500



SUA



SUD



SUS

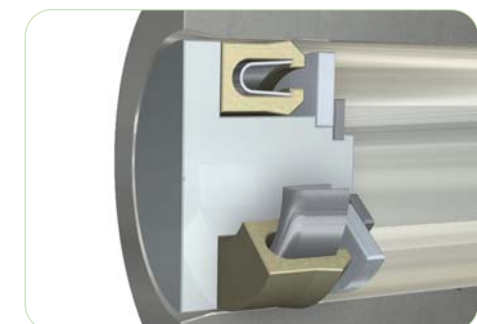
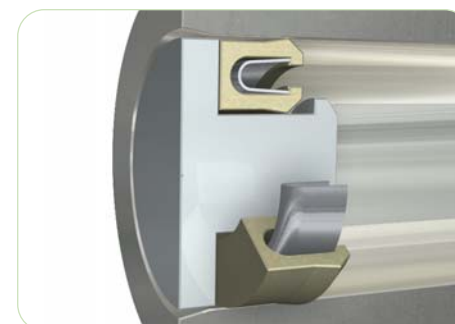

Piston seals, selection matrix

Please select your most important decisive factors when choosing seal design and installation and mark possible solutions. Then study further factors, installation instructions and dimension tables in our technical catalogue, "SKF Hydraulic seals". Figure 5 in the matrix represents the most appropriate design and figure 0 the least appropriate.

Type/series													
Material	PA NBR	PTFE NBR POM	PTFE NBR	PTFE NBR	PUR NBR	NBR POM	NBR TP/PF	NBR POM	NBR POM	PUR POM	PUR	NBR POM	PUR POM
Single-acting													
Double-acting	X	X	X	X	X	X	X	X	X	X	X	X	X
Pressure	< 16 MPa (2 321 psi)	5	5	5	5	5	5	5	5	5	5	5	5
	< 25 MPa (3 626 psi)	5	5	5	5	5	4	4	5	5	5	4	5
	< 40 MPa (5 802 psi)	5	5	5	3	3	4	4	3	4	3	3	3
High temperature	< +110°C (+230°F)	5	5	5	5	4	5	5	5	4	4	5	4
	Low temperature	> -30°C (-22°F)	5	5	4	4	4	4	5	5	3	4	3
Friction	pressure = 0	5	5	5	5	4	4	4	3	4	4	4	4
	pressure > 0	5	5	5	5	5	4	4	4	4	4	4	4
Surface insensitivity	5	5	4	4	5	4	4	3	5	4	5	4	5
Tolerance insensitivity	5	4	4	4	5	4	5	4	5	4	4	4	4
Service life	5	5	4	4	5	4	5	3	5	5	5	4	5
Ease of installation	5	5	5	3	5	5	5	5	4	5	5	5	5
Cost of installation	5	5	5	4	4	5	4	5	3	5	5	5	5
Sealing ability	pressure = 0	5	5	4	4	5	5	5	5	5	5	5	5
	pressure > 0	5	5	4	3	5	5	5	5	5	5	5	5
Preferred in new designs	X	X	X		X								





Hydraulic seals

Rod seals

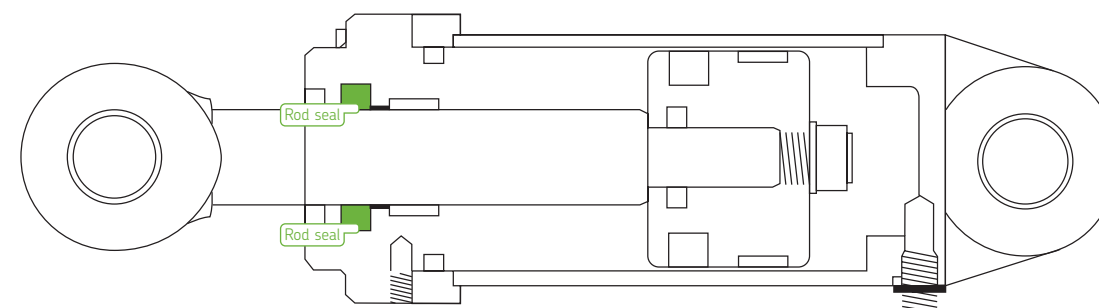
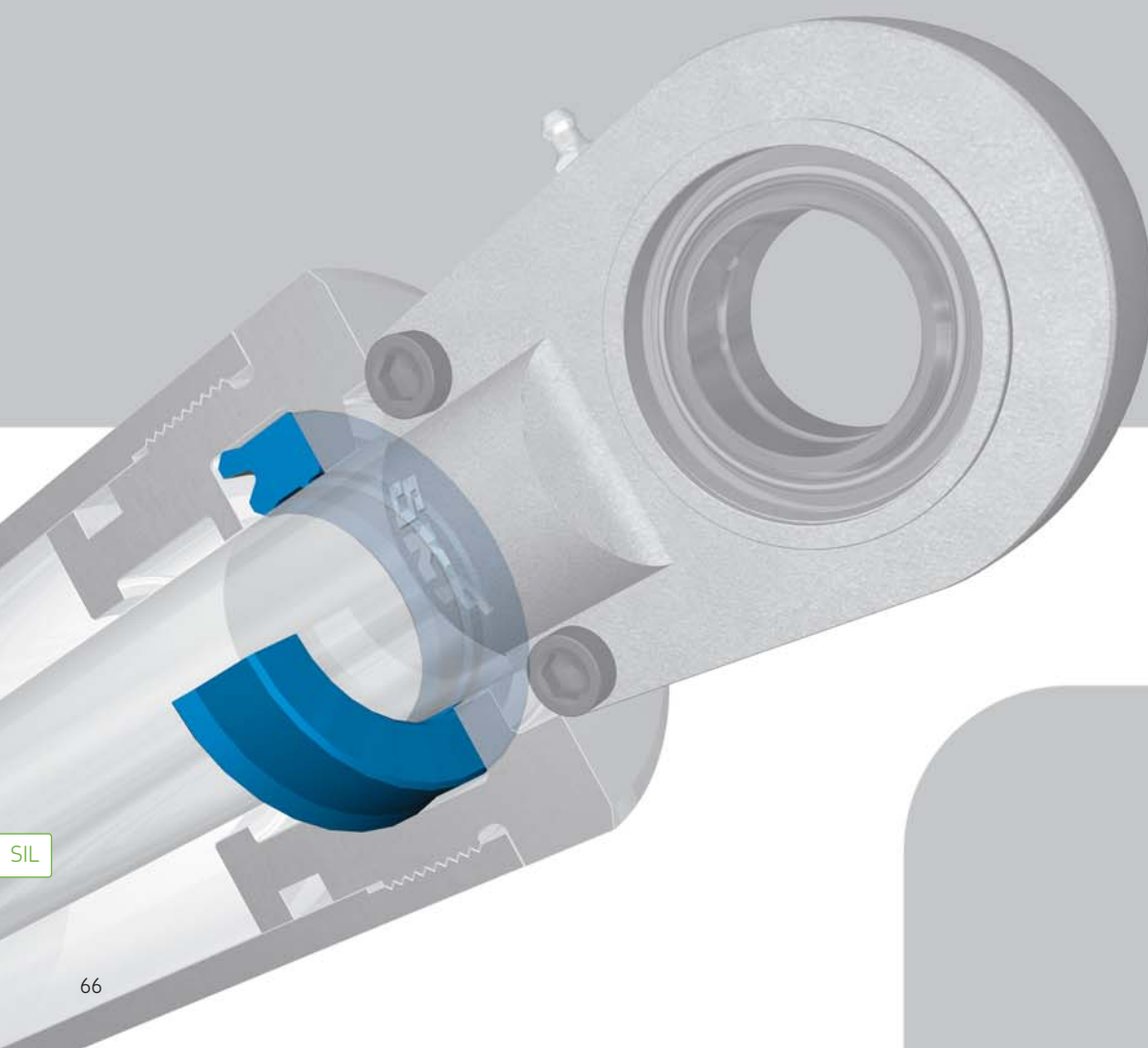

The rod seal is the seal in the hydraulic cylinder with the most demanding requirement specifications. In addition to normal wear and ageing, this seal is directly affected by irregularities on the rod surface. The rod seal is often the decisive factor for the function of the hydraulic cylinder in its entirety. Leakage through the rod seal can in some cases cause accidents and environmental damages. Therefore, it is of significant importance to make the correct choice of rod seal and not the least, to be familiar with the properties of other seal types in rod sealing system.

The rod seal's task is very difficult since it must seal at both high and low pressure, often in combination with alternating high and low temperature. The rod seal must leave a certain lubrication film, thin enough to return into the cylinder after having passed an effective wiper seal. When choosing a rod seal, it is important to define the area of application and to make selection analyses with the support of carefully drawn-up requirement specifications. Rod seals are produced in several different designs in order to function at very varying operating conditions. Unfortunately, there is no completely perfect rod seal satisfying all, often conflicting, demands.

In this publication, we present the standard range of SKF rod seals, with their main design features and operating conditions. For comprehensive technical data and recommendations about the right choice of seal, as well as for information about machining and installation, please see the technical catalogue, "SKF Hydraulic seals".

Rod seals



SIL TIL

Type SIL of polyurethane is our all-round rod seal. This seal is designed with an asymmetrical cross section with a short and strong dynamic seal lip in order to provide good sealing performance also at zero-pressure conditions. The outer seal lip is slightly longer and slimmer than the inner one in order to effectively seal statically at radial and axial movements at both low and high temperatures.

Type TIL of polyurethane is designed with short and strong seal lips providing a good contact force towards the surface of the seal housing groove. Type TIL is more compact than type SIL and is especially suitable for small radial seal sections, i.e. 4 to 6 mm (0.039 to 0.236 in), where this type retains a good sealing performance at low- or zero-pressure conditions.

Types SIL and TIL are both designed with a secondary sealing edge, the main task of which is to reduce the contact surface towards the rod at both low and high temperatures.

Type TICLA is a compact rod seal of polyurethane designed with an integrated support ring of acetal resin protecting the seal against extrusion into the gap. The compact design and the axial support ("nose") minimize the risk of air entering via the rod due to underpressure.



TICLA

Seal type	Seal material	Maximum pressure MPa psi	Maximum linear velocity m/s ft/min	Temperature range °C °F
SIL	PUR	40 5 800	0,5 100	-30 / +90 -20 / +195
TIL	PUR	40 5 800	0,5 100	-30 / +90 -20 / +195
TICLA	PUR, POM	50 7 250	0,5 100	-30 / +90 -20 / +195



SIL



TIL



TICLA

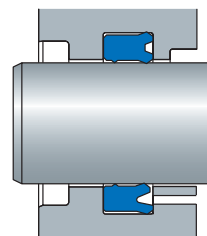

Installation example

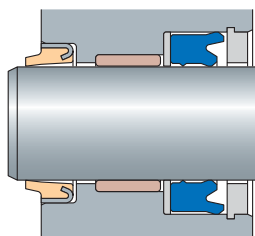

Installation into open groove

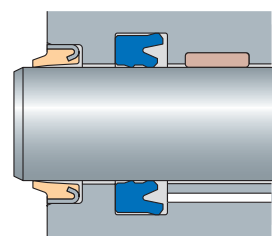

Installation into closed groove



SG

Type SG is a compact rod seal of fabric-reinforced nitrile rubber. The integrated support ring of acetal resin reduces the friction loss and the heat generation.

Type SG is designed for use in new constructions for all-round use within the temperature range of -30 to +100°C (-20°F to +210°F). This seal is also an appropriate choice for applications with hydraulic media based on water added with oil or glycol, where SG can be used in the temperature range -30 to +70°C (-20°F to +160°F).

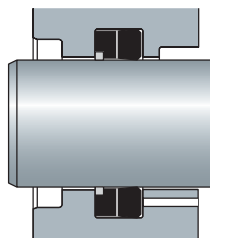

Installation example

Seal type	Seal material	Maximum pressure MPa psi	Max. linear velocity m/s ft/min	Temperature range °C °F
SG	NBR, POM	25 3 625	0,5 100	-30 / +100 -20 / +210



SG



AG

Type AG consists of a central sealing ring of nitrile rubber, a bottom ring of a polyester elastomer and an integrated support ring of acetal resin.

Type AG is designed for use in e.g. hydraulic cylinders subjected to vibrations demanding large radial and axial sections. Type AG can in many applications replace V-seal sets of fabric-reinforced rubber materials.

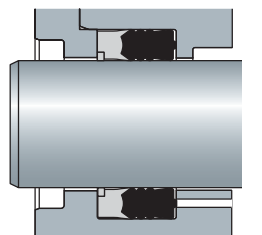

Installation example

Seal type	Seal material	Maximum pressure MPa psi	Maximum linear velocity m/s ft/min	Temperature range °C °F
AG	NBR, POM	40 5 800	0,5 100	-30 / +100 -20 / +210



AG

Rod seals



SKY

Type SKY is a symmetric U-ring seal of nitrile or fluoro rubber, designed to be installed in applications with lack of space and as spare parts for older hydraulic equipment.

Type SKY is preferably completed with a support ring of PTFE at pressures over 14 MPa (2 030 psi).

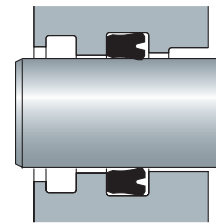

Installation example

Seal type	Seal material	Maximum pressure MPa psi	Maximum linear velocity m/s ft/min	Temperature range °C °F
SKY	NBR	14 2 030	0,5 100	-30 / +100 -20 / +210
SKY + support ring	NBR + PTFE	25 3 625	0,5 100	-30 / +100 -20 / +210



SKY



SI

Type SI is an asymmetric U-ring seal of polyurethane. The outer lip is longer and slimmer in order to provide effective static sealing ability.

This seal type is mostly used as spare part in older hydraulic equipment. For new designs, the technically more advanced series SIL or TIL should be used.

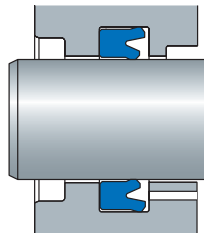

Installation example

Seal type	Seal material	Maximum pressure MPa psi	Maximum linear velocity m/s ft/min	Temperature range °C °F
SI	PUR	40 5 800	0,5 100	-30 / +90 -20 / +195



SI



UN

Type UN is a symmetric U-ring seal of polyurethane for universal use, mostly as a spare part for older hydraulic equipment. For new designed applications, the technically more advanced types SIL or TIL should be used.

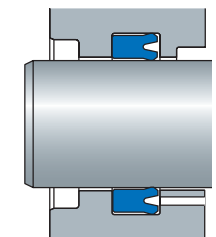

Installation example

Seal type	Seal material	Maximum pressure MPa psi	Maximum linear velocity m/s ft/min	Temperature range °C °F
UN	PUR	40 5 800	0,5 100	-30 / +90 -20 / +195



UN



TI

Type TI is a U-ring seal of polyurethane designed with short, symmetric and strong seal lips, providing a good contact force towards the surface of the seal housing groove.

The compact geometry of the type TI makes it suitable for small radial seal section dimensions. Particularly suited for use in applications with vibrations and under pulsating pressure.

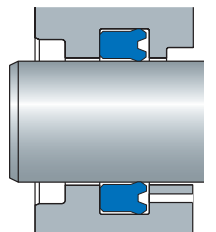

Installation example

Seal type	Seal material	Maximum pressure MPa psi	Maximum linear velocity m/s ft/min	Temperature range °C °F
TI	PUR	40 5 800	0,5 100	-30 / +90 -20 / +195



TI

Rod seals

Series G and GL



All types of series G and GL consist of a dynamically sealing slide ring of PTFE or other thermo-plastic materials and a static, elastomeric part, which also functions as an interference element. They are available in different designs and material combinations, all to meet demands on low friction, small housing dimensions and a long service life. Main difference between series G and GL is the slightly lower section of the slide ring of series GL. The basic design of series GL is made of unfilled PTFE, while the basic design of series G is made of a bronze-filled PTFE compound.

The following table gives a first indication about the right choice of type for different application demands. Comprehensive technical data and selection criteria can be found in our technical catalogue, "SKF Hydraulic seals".



Seal type	Seal material	Maximum pressure MPa psi	Maximum linear velocity m/s ft/min	Temperature range °C °F
GL, GLC, GLG	PTFE, NBR	16 2 320	2 395	-30 / +100 -20 / +210
GC, G, GG, GN, GS, GS-XX8, GR	PTFE, NBR	25 3 625	2 395	-30 / +100 -20 / +210

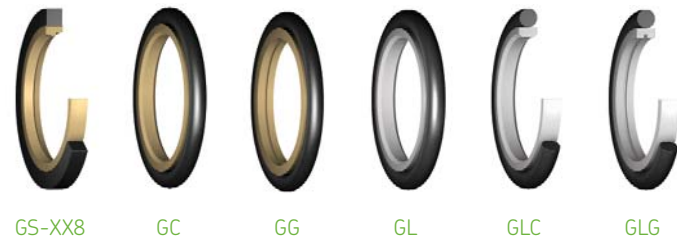

Features and field of application of SKF slide ring seals

G, GL	Double-acting, sharp edges at the dynamic outside diameter and recommended for the use in light- or medium-duty hydraulic cylinders, where impure media may occur.
GC, GLC	Double-acting, chamfered edges at the dynamic outside diameter to reduce the risk of extrusion.
GG, GLG	Double-acting, sharp edges at the dynamic outside diameter and a groove in the sliding surface for improved sealing ability.
GS-XX8	Double-acting, square cut energizer providing reduced pressure against the dynamic surface and increased static sealing ability.
GN	Double-acting, notches in both side faces, recommended for cylinders with rapid pressure changes
GR	Double-acting, notches in both side faces, recommended for cylinders with rapid pressure changes
GR	Double-acting, chamfered edges at the dynamic outside diameter, a groove in the sealing surface and notches in both side faces. Additionally the slide ring has a radius on the static side for optimal function together with the O-ring type energizer. Recommended for applications where additional rotating or slewing movements may occur.
GS	Single-acting, recommended for applications with high demands on sealing ability

Choice of material

Medium	Material contact surface	Slide ring material	O-ring material
Hydraulic oil Lubrication oil (mineral oil based)	Steel: min 33 HRC Chromed surface, cast iron	1) PTFE + bronze 2) PTFE + glass fibre 3) PE-UHMW	NBR NBR NBR
	Stainless steel, aluminium, anodized or chromed bronze	1) PTFE + carbon 2) PTFE + carbon fibre 3) PE-UHMW	F F F
Water Water/glycol	Steel: min 33 HRC Chromed surface, cast iron,	1) PTFE + carbon 2) PTFE + carbon fibre	NBR F E
	stainless steel, aluminium, anodized or chromed bronze	3) PTFE + carbon 4) PE-UHMW	NBR F
Water/oil emulsion	Steel: min 33 HRC Chromed surface, cast iron, stainless steel, aluminium, anodized or chromed bronze	1) PTFE + carbon 2) PTFE + carbon fibre 3) PTFE + carbon	E E E
			E E E
Air, lubricated service Air, non-lubricated service	Steel: min 33 HRC Chromed surface, cast iron	1) PE-UHMW 2) PTFE + glass fibre 3) PTFE + low-filled + colour pigment, only lubricated service	NBR NBR NBR
	Stainless steel, aluminium, anodized or chromed bronze	1) PE-UHMW 2) PTFE + carbon 3) PTFE + carbon fibre 4) PTFE + carbon	NBR NBR NBR NBR

More information on choice of material combinations can be found in our catalogue "SKF Hydraulic seals".

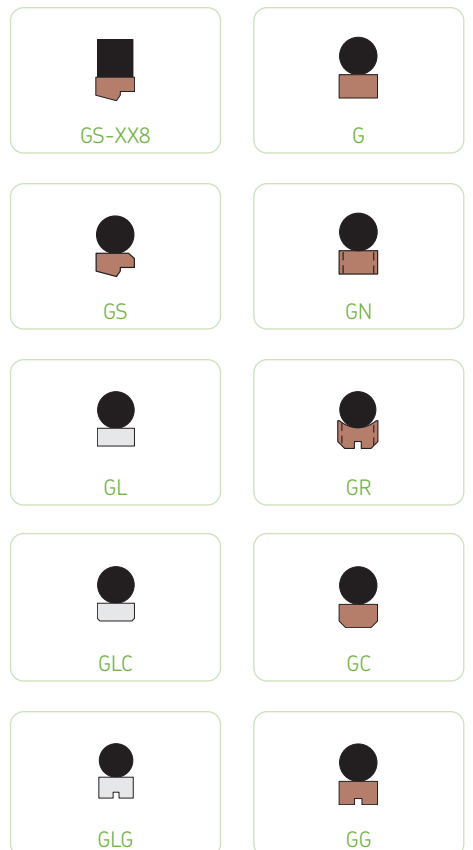

Rod seals

Series CH



CH-5



CH-7

SKF multi-piece seal sets in the CH series are designed for adjustable or fix seal housings and are available in two different designs:

- CH-5: Multi-piece seal consisting of a bottom ring and three V-type sealing rings of fabric-reinforced nitrile rubber and a top ring of fabric-reinforced nitrile rubber or acetal resin.
- CH-7: Multi-piece seal consisting of a bottom ring and five V-type sealing rings of fabric-reinforced nitrile rubber and a top ring of fabric-reinforced nitrile rubber or acetal resin.

CH multi-piece seal sets are suitable for heavy-duty applications e.g. in presses, marine hydraulics or road moulding systems. They are today preferably used for spare part requirements.



CH-5



CH-7

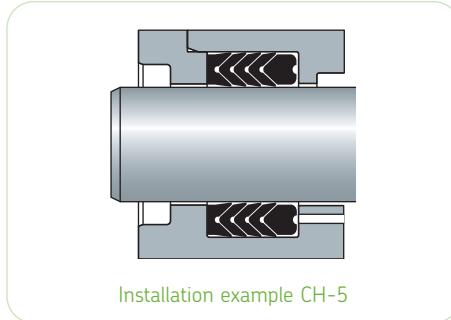

Installation example CH-5

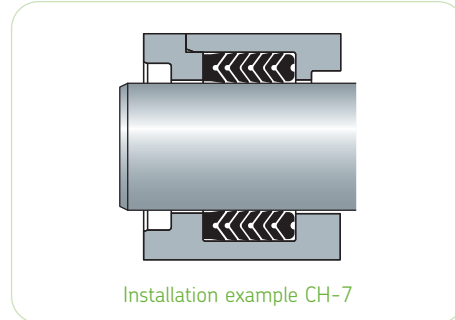

Installation example CH-7

Seal type	Seal material	Maximum pressure MPa psi	Maximum linear velocity m/s ft/min	Temperature range °C °F
CH-5	NBR	25 3 625	0,5 100	-30 / +100 -20 / +210
CH-7	NBR	25 3 625	0,5 100	-30 / +100 -20 / +210

Spring activated rod seals

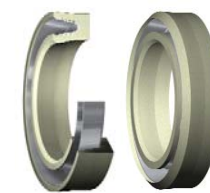

SUA SUD

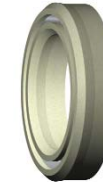

SUS

Seals of series SU are single-acting PTFE seals, preloaded by springs of stainless steel. They are used as a dynamic seal at slowly rotating or reciprocating movements as well as a shaft seal or a static seal.

Seals of series SU often replace a rubber seal, e.g. an O-ring, in applications with very high or low temperatures, non-lubricated services, demands on low friction, aggressive media, high speeds, high pressures, vacuum etc. Series SU can be delivered with many different spring types and materials adjusted to the application demands. The most commonly used types are:

- SUA: asymmetrical design with a wiper lip
- SUD: asymmetrical design with a strong dynamic lip
- SUS: symmetrical design for static applications

Seal type	Seal material	Maximum pressure MPa psi	Maximum linear velocity m/s ft/min	Temperature range °C °F
SUA	PTFE + Stainless steel	25 3 625	15 2 950	-200 / +260 -330 / +500
SUD	PTFE + Stainless steel	25 3 625	15 2 950	-200 / +260 -330 / +500
SUS	PTFE + Stainless steel	25 3 625	15 2 950	-200 / +260 -330 / +500

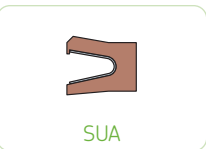

SUA

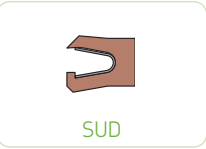

SUD



SUS



Support rings for rod seals



STR-D/A

The SKF product range also includes accessories for rod seal systems.

Type STR-D/A is a support ring of acetal resin for rod seals with the same sectional dimension as that of the seal, called "full face". The main task of the support ring is to improve the seal's resistance to extrusion into the clearance on its low-pressure side. The basic design is split to facilitate assembly to the back side face of the seal.

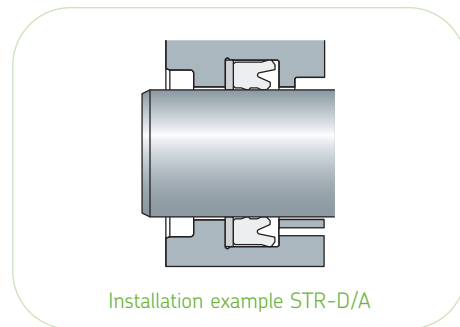

Installation example STR-D/A

Seal type	Seal material	Maximum pressure MPa psi	Maximum linear velocity m/s ft/min	Temperature range °C °F
STR-D/A	POM	- -	0.5 100	-30 / +100 -20 / +210

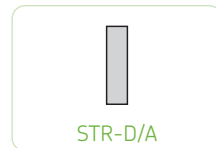

STR-D/A

Retainer rings for rod seals



RI

The use of an open housing design is possible for light applications and has several advantages; it facilitates the machining methods and simplifies the seal assembly. However, a retainer ring of acetal resin, type RI, needs to be installed on the pressure side of the rod seal to secure its position.

Seal type	Seal material	Maximum pressure MPa psi	Maximum linear velocity m/s ft/min	Temperature range °C °F
RI	POM	- -	0.5 100	-30 / +100 -20 / +210

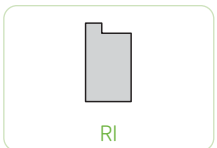

RI

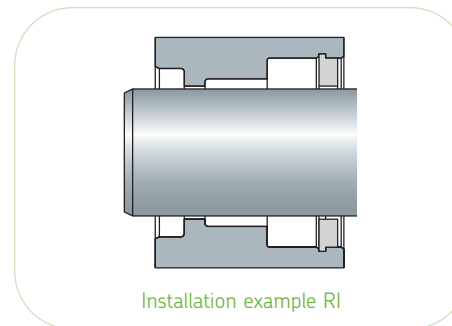

Installation example RI

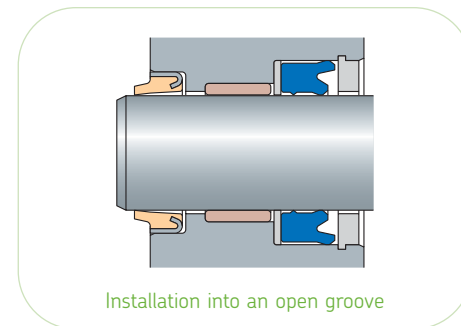

Installation into an open groove

Rod seals, selection matrix

Please select your most important decisive factors when choosing seal design and installation and mark possible solutions. Then study further factors, installation instructions and dimension tables in our technical catalogue, "SKF Hydraulic seals". Figure 5 in the matrix represents the most appropriate design and figure 0 the least appropriate.

																
Type/series		SIL	TIL	TICLA	GS	SG	AG	SKY	UN	SI	TI	TILA	GL	CH-5/CH-7	STR-D/A	RI
Material		PUR	PUR	PUR POM	PTFE NBR	NBR POM	NBR POM	NBR	PUR	PUR	PUR	PUR POM	PTFE NBR	NBR	POM	POM
Pressure	< 16 MPa (2 321 psi)	5	5	5	5	5	5	4	4	4	4	5	4	5	-	-
	< 25 MPa (3 626 psi)	5	5	5	5	5	5	2	3	3	3	5	4	5	-	-
	< 40 MPa (5 802 psi)	4	4	5	4	4	5	0	2	2	2	4	3	3	-	-
High temperature	> +110°C / +230°F	4	4	4	5	5	5	5	4	4	4	4	5	5	-	-
	Low temperature	< -30°C / -22°F	5	4	4	4	4	4	3	3	3	3	4	5	-	-
Friction	pressure = 0	4	4	4	5	4	3	5	4	4	4	4	5	2	2	-
	pressure > 0	4	3	4	5	4	3	4	3	3	3	4	5	3	3	-
Surface insensitivity		5	5	5	3	3	4	3	5	5	5	5	3	3	-	-
Tolerance insensitivity		5	5	5	4	5	5	4	5	5	5	5	4	5	-	-
Service life		4	4	4	3	3	4	3	5	5	4	4	2	5	-	-
Ease of installation		5	5	4	3	4	4	5	5	5	5	5	3	4	-	-
Cost of installation		5	5	4	5	5	4	5	5	5	5	5	5	3	-	-
Sealing ability	pressure = 0	4	4	5	4	5	5	5	3	3	4	4	4	4	-	-
	pressure > 0	5	5	5	4	4	4	5	4	5	5	5	3	4	-	-
Preferred in new designs		X	X	X	X										X	X



Hydraulic seals

Wiper seals

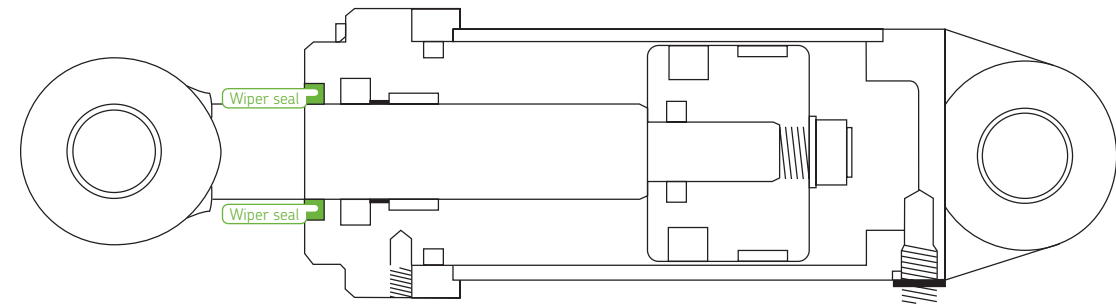
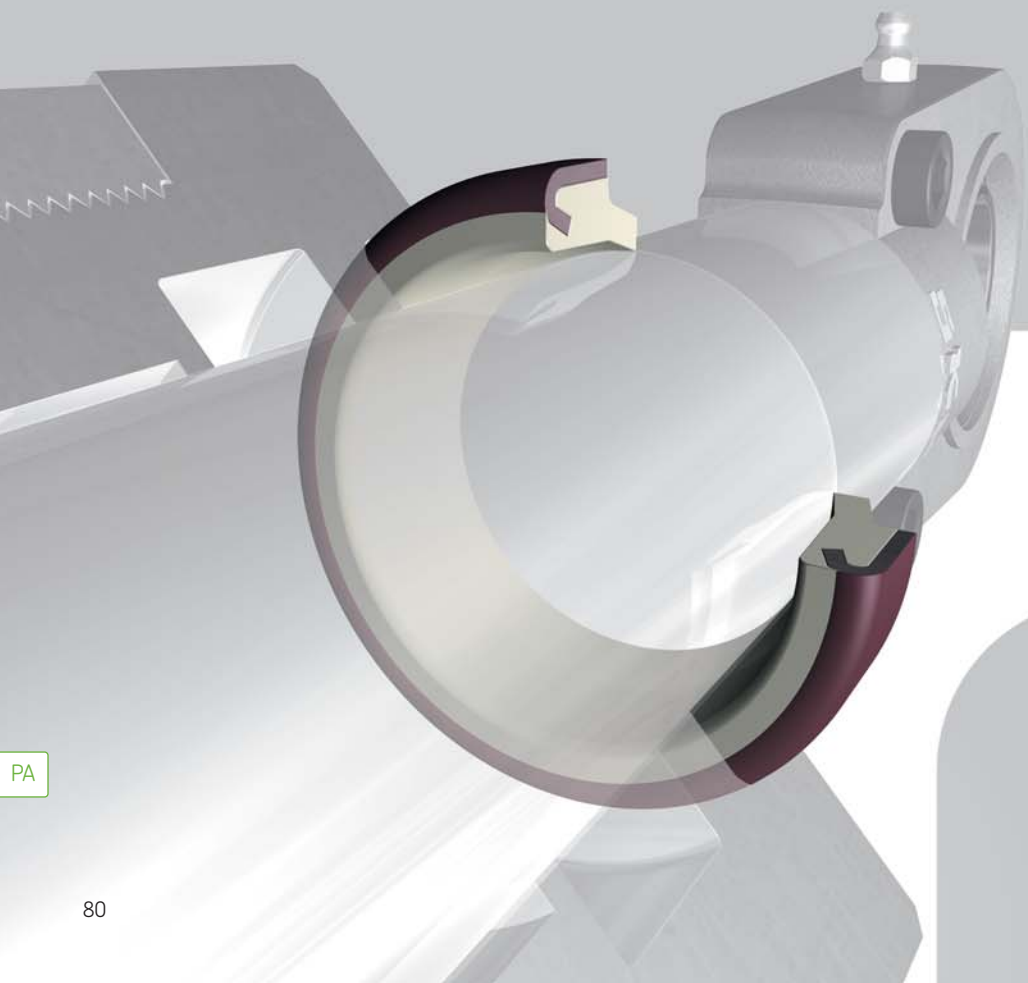

Contamination particles in the hydraulic system are the most common reasons for breakdowns and short service life of seals. A major part of the particles reaches the system through the rod. The wiper seal's task is to prevent this.

The wiper seal is nevertheless the most undervalued seal type in the hydraulic cylinder in relation to its important function. The choice of wiper seal should, however, be founded on as carefully drawn-up requirement specifications as the choice of piston and rod seals. The surrounding environment and service conditions must be taken into special consideration.

The wiper seal should be designed not only to fit the rod (dynamic function) but also to seal in the housing groove (static function). In this publication, we present the standard range of SKF wiper seals, with their main design features and operating conditions.

For comprehensive technical data and recommendations about the right choice of wiper seal, as well as for information about machining and installation, please see our technical catalogue, "SKF Hydraulic seals".



Wiper seals

Metal-reinforced wiper seals



PA PAK

Type PA is a metal-reinforced, single-acting wiper seal of polyurethane with a steel case for press fit assembly. Thanks to the design of the wiper lip and the specifically chosen material, a high and durable contact force is achieved. The metal case design provides a very high rigidity close to the bottom of the housing for an optimal fixation. Type PA is our most effective wiper seal type for demanding applications.

Type PAK is a metal-reinforced, single-acting wiper seal of polyurethane with a steel case for press fit assembly. Contrary to the type PA, type PAK has the same width as the housing groove which makes this type appropriate also for sealing of e.g. bushings.

Type PAD is a metal-reinforced, double-acting wiper seal of polyurethane with a steel case for press fit assembly. Thanks to its U-shape it also has a sealing function to further reduce the oil transport passing the rod seal. Type PAD is designed to be used in heavy-duty applications. Type PAD can be completed with a retainer ring to withstand very tough service conditions.

Metal-reinforced wiper seal types are intended for assembly into open housings. For comprehensive technical data and recommendations machining and installation, please see our technical catalogue, "SKF Hydraulic seals".



PAD

Seal type	Seal material	Max. linear velocity m/s ft/min	Temperature range °C °F
PA	PUR	2 395	-40 / +90 -40 / +195
PAK	PUR	2 395	-40 / +90 -40 / +195
PAD	PUR	2 395	-40 / +90 -40 / +195



PA



PAK



PAD

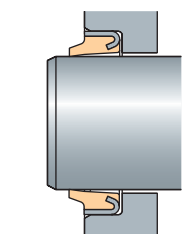

Installation example PA

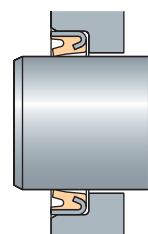

Installation example PAK

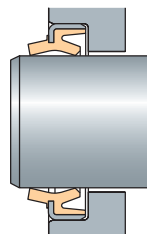

Installation example PAD



GA SCB

For less demanding applications, metal-reinforced wiper seals with a rubber lip material, normally nitrile rubber 80° IRH, are used.

Type GA is a metal-reinforced, single-acting wiper seal of nitrile rubber for press fit assembly. Type GA can also be manufactured of fluoro rubber at request. Type GA is designed to be used in light- or medium-duty applications.

Type SCB is a double-acting, metal-reinforced wiper seal of nitrile rubber for press fit assembly. Type SCB can also be manufactured of fluoro rubber at request. Type SCB is designed to be used in medium-duty applications. Type SCB can be completed with a retainer ring to withstand even tougher conditions.

Seal type	Seal material	Max. linear velocity m/s ft/min	Temperature range °C °F
GA	NBR	2 395	-30 / +100 -20 / +210
SCB	NBR	2 395	-30 / +100 -20 / +210
	FKM	2 395	-20 / +150 -5 / +300

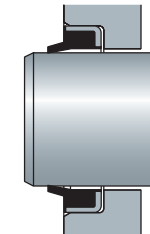

Installation example GA

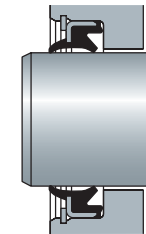

Installation example SCB



GA



SCB

Wiper seals

PTFE wiper seals



P02

Type P02 is a double-acting PTFE wiper seal with an energizing O-ring of nitrile rubber providing the static sealing function. The O-ring is also available in other rubber materials, e.g. fluoro rubber.

This type is designed to be used in applications with aggressive media, high temperatures or specific demands for low friction.

Type P0 is a PTFE wiper seal with an energizing O-ring of nitrile rubber providing the static sealing function. The O-ring is also available in other rubber materials, e.g. fluoro rubber.

This type is designed to be used in applications with aggressive media, high temperatures or specific demands for low friction.

For new designed applications type P02 is preferable.



P0

Seal type	Seal material	Max. linear velocity m/s ft/min	Temperature range °C °F
P02	PTFE, NBR	15 2 950	-40 / +110 -40 / +230
	PTFE, FKM	15 2 950	-30 / +150 -20 / +300
P0	PTFE, NBR	15 2 950	-40 / +110 -40 / +230
	PTFE, FKM	15 2 950	-30 / +150 -20 / +300

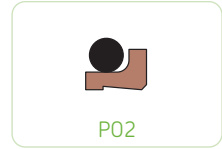

P02

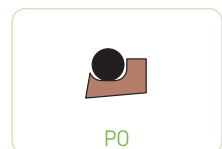

P0

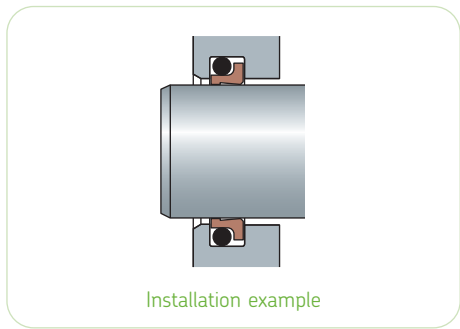

Installation example

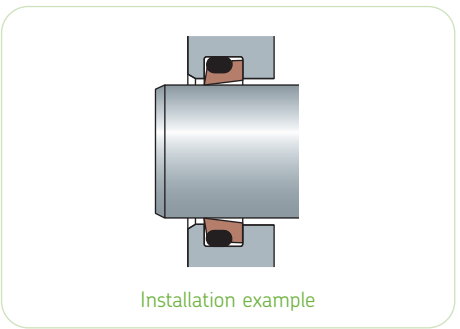

Installation example

Rubber wiper seals



SDR

Type SDR is a double-acting wiper seal of nitrile rubber for assembly into closed housings. Type SDR can also be manufactured of fluoro rubber at request.

Type SDR is designed for light-duty hydraulic applications.

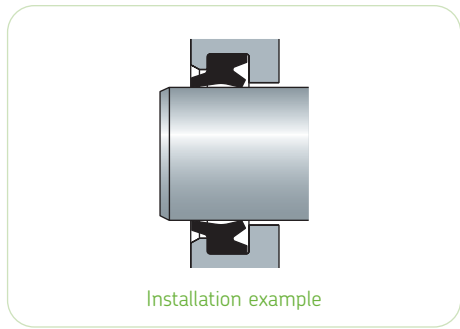

Installation example

Seal type	Seal material	Max. linear velocity m/s ft/min	Temperature range °C °F
SDR	NBR	2 395	-30 / +100 -20 / +210
	FKM	2 395	-20 / +150 -5 / +300

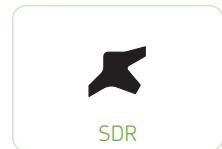

SDR



SER

Type SER is a single-acting, mini wiper seal of nitrile rubber for assembly into closed housings.

This type is designed for light-duty hydraulic applications.

Type SER can also be manufactured of fluoro rubber at request.

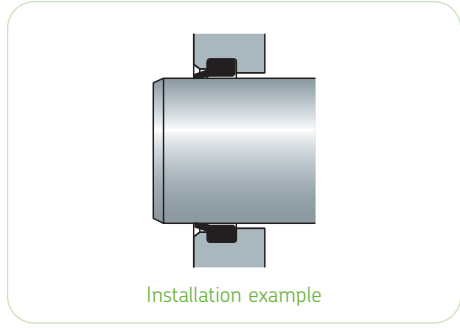

Installation example

Seal type	Seal material	Max. linear velocity m/s ft/min	Temperature range °C °F
SER	NBR	2 395	-30 / +100 -20 / +210
	FKM	2 395	-20 / +150 -5 / +300



SER

Wiper seals

All-elastomer wiper seals



PWY

Type PWY is a single-acting wiper seal of polyurethane to be assembled into closed housings.

This type has an outwards-directed sealing lip against the retainer diameter to provide improved static sealing ability in the housing. The wiper body is also equipped with radial ridges to prevent the wiper seal section tendency to be distorted

Type PWB is a single-acting wiper seal of polyurethane to be assembled into closed housings.

This type has an axial static sealing edge on the front face of the wiper body to provide fixation in the housing and axial ridges on the inside diameter to prevent the wiper seal section tendency to get



PWB

Seal type	Seal material	Max. linear velocity m/s ft/min	Temperature range °C °F
PWY	PUR	2 395	-30 / +90 -20 / +195
PWB	PUR	2 395	-30 / +90 -20 / +195



PWY



PWB

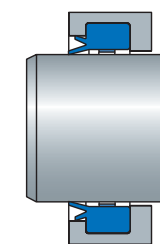

Installation example

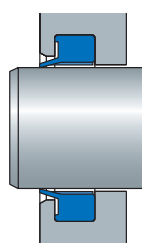

Installation example



RSW

Type RSW is a double-acting wiper seal of polyurethane to be assembled into closed housings.

This type is designed for use in light-duty hydraulic applications.

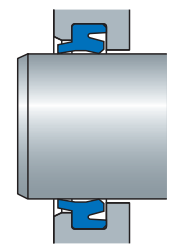

Installation example

Seal type	Seal material	Max. linear velocity m/s ft/min	Temperature range °C °F
RSW	PUR	2 395	-30 / +90 -20 / +195



RSW



PW

Type PW is a single-acting wiper seal of polyurethane for assembly into closed housings in medium-duty applications. This wiper has an axial static sealing edge on the front to provide fixation in the housing. Type PW can also be manufactured of fluoro rubber at request.

For new designed applications, the similar wiper type PWB with axial ridges on the inside diameter to prevent distortion, is preferable.

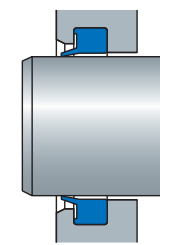

Installation example

Seal type	Seal material	Max. linear velocity m/s ft/min	Temperature range °C °F
PW	PUR	2 395	-30 / +100 -20 / +210



PW

Wiper seals

Elastomer wiper seals



PWF

Type PWF is a single-acting wiper seal of polyurethane for assembly into closed housings.

Type PWF is designed for medium-duty hydraulic applications.

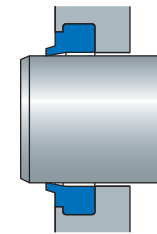

Installation example

Seal type	Seal material	Max. linear velocity m/s ft/min	Temperature range °C °F
PWF	PUR	2 395	-30 / +90 -20 / +195



PWF



PPUA

Type PPUA is a single-acting wiper seal of polyurethane with an axial static sealing edge on the front corner of the wiper body. To be used on pistons in single-acting cylinders.

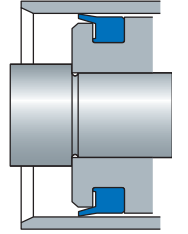

Installation example

Seal type	Seal material	Max. linear velocity m/s ft/min	Temperature range °C °F
PPUA	PUR	2 395	-30 / +90 -20 / +195



PPUA



DK

Type DK is a single-acting wiper seal of polyurethane for assembly into closed housings.

Type DK is designed for light-duty hydraulic applications.

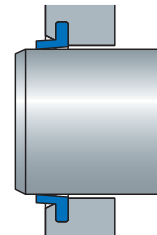

Installation example

















Seal type	Seal material	Max. linear velocity m/s ft/min	Temperature range °C °F
DK	PUR	2 395	-30 / +100 -20 / +210



DK

Wiper seals, selection matrix

Please select your most important decisive factors when choosing wiper seal design and installation and mark possible solutions. Then study further factors, installation instructions and dimension tables in our technical catalogue, "SKF Hydraulic seals". Figure 5 in the matrix represents the most appropriate design and figure 0 is the least appropriate.

Type/series																
Material	PUR	PUR	PUR	NBR FKM	NBR	PUR	PUR	PUR	PTFE FKM	PTFE FKM	NBR FKM	NBR FKM	PUR	PUR	PUR	PUR
High temperature (+110°C, +230°F)	4	4	4	4	4	4	4	3	5	5	4	4	3	4	3	3
Low temperature (-40°C, -40°F)	5	5	5	4	4	5	5	4	3	3	4	4	3	2	3	3
Friction	3	4	3	4	4	4	4	4	5	5	4	5	4	5	4	4
Surfaces insensitivity	5	5	5	3	3	5	5	4	3	3	4	4	4	3	4	4
Tolerances insensitivity	4	4	4	4	4	4	4	4	3	3	4	4	3	2	3	3
Service life	5	5	5	3	3	4	4	4	2	2	4	4	4	2	4	4
Ease of installation	5	5	5	5	5	4	4	4	3	3	4	4	4	4	4	4
Fixation in the housing	5	5	5	4	5	4	4	3	4	4	4	4	4	4	4	3
Cost of installation	5	5	5	5	5	4	3	3	3	3	3	3	3	3	3	3
Wiping ability	5	4	5	3	4	4	4	4	4	3	3	3	3	2	3	4
Static sealing in the housing	5	5	5	5	5	5	4	4	3	4	3	3	2	1	3	2
Preferred in new designs	X	X	X	X		X	X		X							





GUIDES

Hydraulic seals Guides

The purpose of guide rings and guide strips of plastic materials is to guide the piston in the cylinder bore and the rod in the cylinder head in a working hydraulic cylinder as well as to withstand arising side loads and prevent metallic contact between these axially mobile parts.

We recommend the materials phenolic/fabric, acetal resin or PTFE for guides depending on the prerequisites of the application.

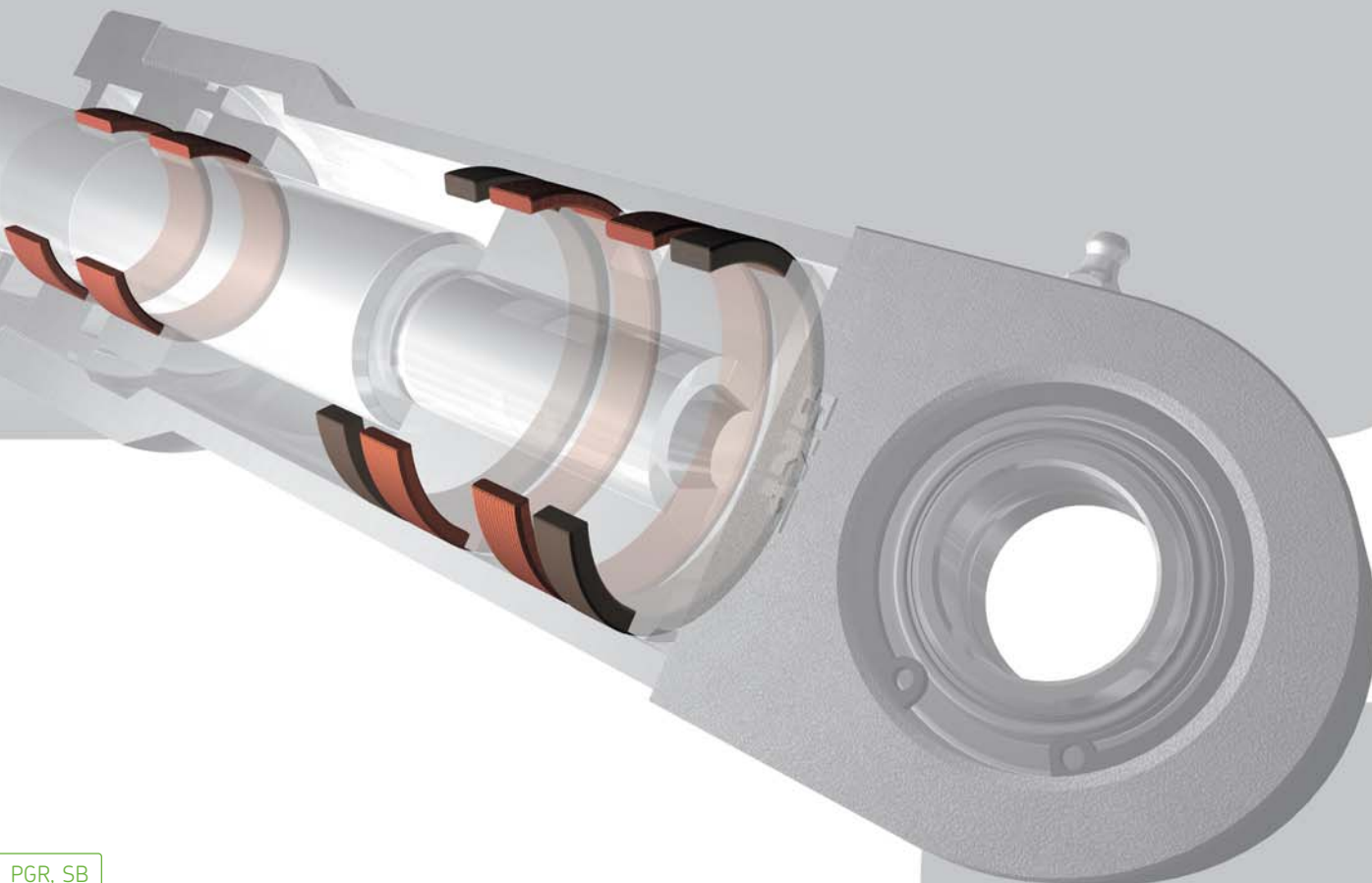

	Guide types for rod		Guide types for piston	
Phenolic/fabric Acetal resin PTFE	RGR-PF RGR-A SB, SB/C		PGR-PF PGR-A SB, SB/C	
Application field	Phenolic/fabric	Acetal resin	PTFE	
Mobile hydraulics	x			
Agricultural hydraulics		x		
Industrial hydraulics	x	x	x	
Process hydraulics			x	
Water hydraulics			x	
Food industry hydraulics			x	

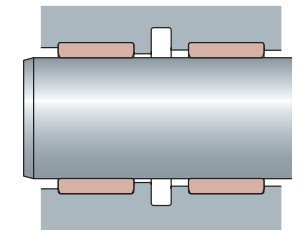

Installation example for rods

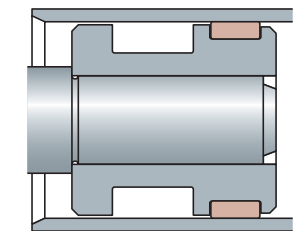

Installation example for pistons

PGR, SB

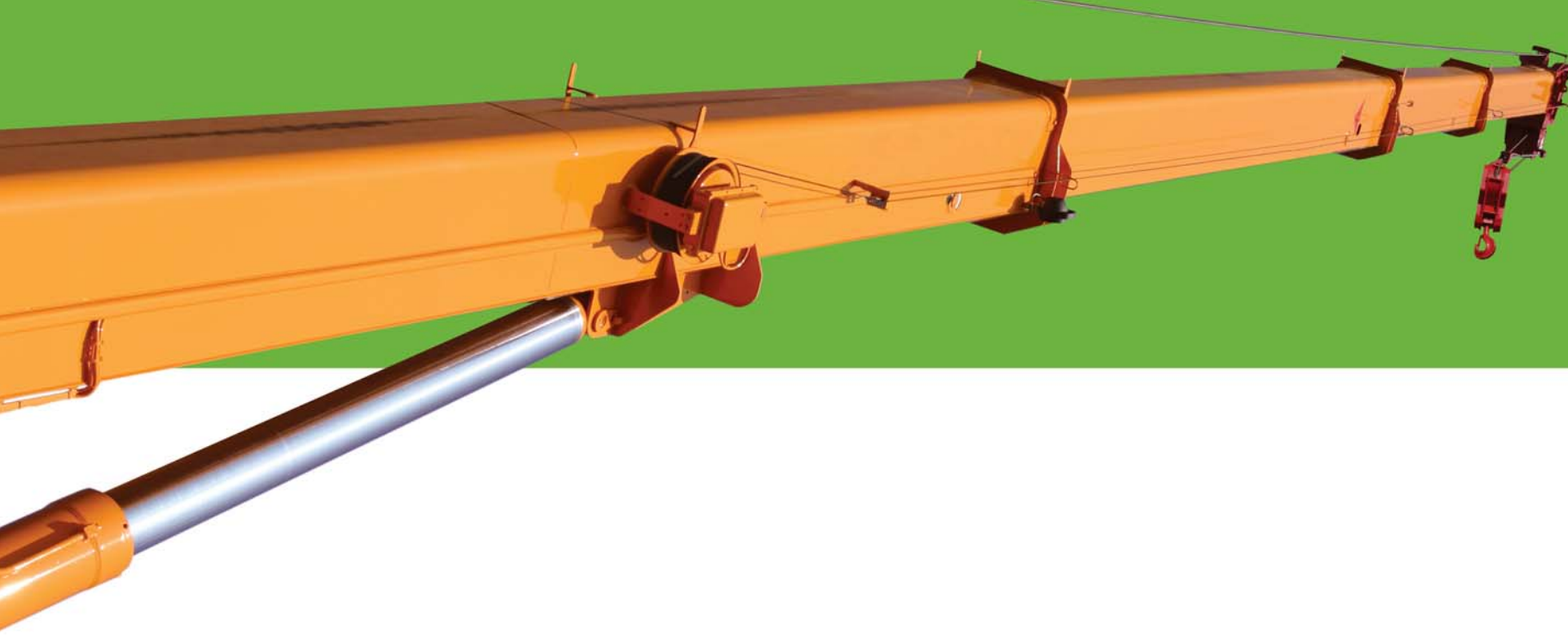

Static seals

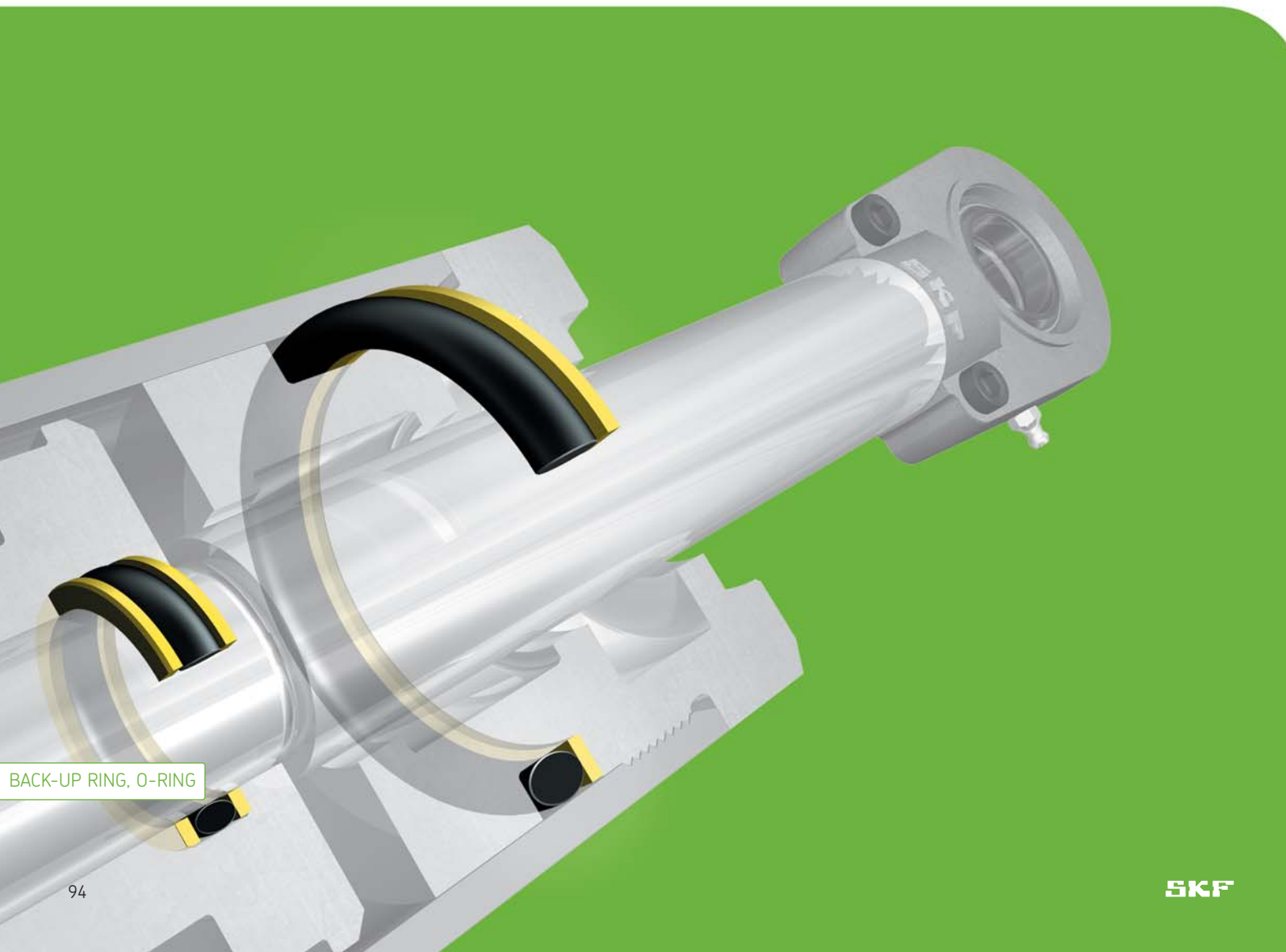

O-RING

BACK-UP RINGS

The O-ring is one of the most common sealing devices and is used in the most different applications. The design is unique with its ingenious simplicity. The O-ring seals through its deformation between the surfaces against which it is supposed to seal. The working pressure at which the O-ring can be used is dependent on, among others, the installation mode, fitting clearance, the O-ring material, sealed medium and temperature. O-rings of a hard material generally provide an inferior sealing ability at low pressures due to large permanent deformation.

O-rings are often used as static sealing elements in hydraulic systems. However, they tend to extrude into the clearance already at low pressures and are thereby destroyed. A common solution is to use O-rings of a material with increased hardness, e.g. 90° IRH. This provides a certain improvement, but a better solution for hydraulic applications is instead to combine O-rings for static functions with back-up rings.

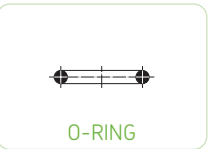

O-RING

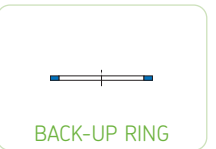

BACK-UP RING

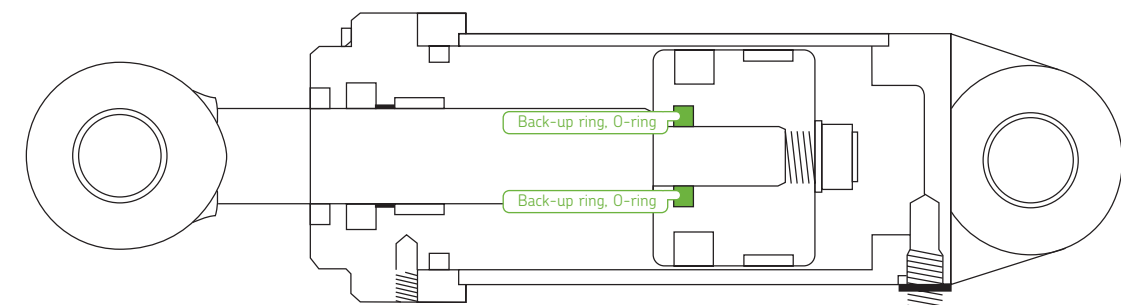

O-rings



O-RINGS

ECOR



OR

We normally stock standard O-rings of nitrile rubber (NBR) 70° IRH. When necessary, the alternative hardness 90° can be delivered at request. It is, however, better to choose 70° IRH and combine the O-ring with a back-up ring.

For applications with temperatures over +100°C (+212°F) fluoro rubber (FKM) or silicone rubber (Q) can be appropriate, depending on the medium.



ECOR

In our catalogue "SKF Hydraulic seals" you will find a wide range of O-ring sizes and fundamental technical information. Detailed information about O-ring sizes and tolerances, installation instructions and in some cases material properties you will find in common national and international standards, e.g. SMS 1586 and ISO 3601. We will be pleased to inform you about them.

PTFE encapsulated O-rings, type ECOR

Type ECOR is an O-ring consisting of a seamless and uniform PTFE encapsulation which completely encloses the core material of either silicone or fluoro rubber to protect it from media and air.

The function is the same as for a normal O-ring that is compressed in the groove and is working statically. Type ECOR is not appropriate for continuously dynamic applications due to its thin and soft case.

Advantages of ECOR

- Chemically resistant to aggressive media thanks to the PTFE encapsulation
- Wide temperature range, -60 to +205°C (-80 to +400°F), material type PFA +260°C (+500°F)
- Anti-adhesive, no stick-slip effects
- Sterilisable, FDA approved
- Low steam permeability and low water absorption
- Low compression set solution.

Back-up rings



BACK-UP RINGS



STR

Back-up rings are intended to be used together with O-rings when the fitting clearance between the surfaces that the O-ring should seal is large enough to allow the O-ring to extrude at certain working pressures. In installations with normal and standardized dimensions and tolerances the O-ring normally must be completed with back-up ring(s) if the working pressure exceeds 10 MPa (1 450 psi), depending on the temperature.

In applications where the O-ring is exposed to pressure from one side only, the back-up ring is installed at the zero pressure side. For an O-ring exposed to pressure from both sides a back-up ring is assembled on either side.

Our back-up rings are kept in stock with a basic design and are produced of polyurethane 95° Shore A or of a polyester elastomer, 95° Shore A. This enables the use of back-up rings in most applications with normal pressure media and temperatures.

In applications with high temperatures or aggressive media back-up rings of a PTFE material are suitable, either unfilled or with an appropriate filler. We keep a large number of sizes of unfilled back-up rings of PTFE in stock. These are machine finished and can therefore be delivered within short notice.

Product index

Type/series	Description	Page	Type/series	Description	Page	Type/series	Description	Page	Type/series	Description	Page
A	Hydraulic seal	60	HDS2	Radial shaft seal	23	MUD1	Radial shaft seal	34	SCB	Hydraulic seal	83
AG	Hydraulic seal	69	HDS3	Radial shaft seal	23	MUD2	Radial shaft seal	34	SCOTSEAL CLASISC	Radial shaft seal	35
CH-5	Hydraulic seal	73	HDS4	Radial shaft seal	26	MUD3	Radial shaft seal	34	SCOTSEAL LONGLIFE	Radial shaft seal	35
CH-7	Hydraulic seal	73	HDS6	Radial shaft seal	26	MUD4	Radial shaft seal	34	SCOTSEAL PLUS XL	Radial shaft seal	35
CRS1	Radial shaft seal	13	HDS7	Radial shaft seal	22	MUD5	Radial shaft seal	34	SDR	Hydraulic seal	85
CRSA1	Radial shaft seal	13	HDSA1	Radial shaft seal	24	MUD6	Radial shaft seal	34	SER	Hydraulic seal	85
CRSH1	Radial shaft seal	13	HDSA2	Radial shaft seal	24	MUD7	Radial shaft seal	34	SG	Hydraulic seal	69
CRSHA1	Radial shaft seal	13	HDSB1	Radial shaft seal	24	MVR1	Axial shaft seal	46	SI	Hydraulic seal	71
CRW1	Radial shaft seal	14	HDSB2	Radial shaft seal	24	MVR2	Axial shaft seal	46	SIL	Hydraulic seal	68
CRW5	Radial shaft seal	15	HDSD1	Radial shaft seal	24	OR	Hydraulic seal	96	SKY	Hydraulic seal	70
CRWA1	Radial shaft seal	14	HDSD2	Radial shaft seal	24	PA	Hydraulic seal	82	SPEEDI-SLEEVE	Wear sleeve	41
CRWA5	Radial shaft seal	15	HDSE1	Radial shaft seal	24	PAD	Hydraulic seal	82	STR	Hydraulic seal	97
CRWH1	Radial shaft seal	14	HDSE2	Radial shaft seal	24	PAK	Hydraulic seal	82	STR-D/A	Hydraulic seal	77
CRWHA1	Radial shaft seal	14	HMS4	Radial shaft seal	13	PGR	Hydraulic seal	93	SUA	Hydraulic seal	63
CT1	Axial shaft seal	46	HMS5	Radial shaft seal	12	PO	Hydraulic seal	84	SUD	Hydraulic seal	63
CT3	Axial shaft seal	46	HMSA10	Radial shaft seal	12	PO2	Hydraulic seal	84	SUS	Hydraulic seal	63
CT4	Axial shaft seal	46	HMSA7	Radial shaft seal	13	PPUA	Hydraulic seal	89	SWRR	Hydraulic seal	62
CUT	Hydraulic seal	54	HS3	Radial shaft seal	27	PW	Hydraulic seal	87	TI	Hydraulic seal	71
DK	Hydraulic seal	89	HS4	Radial shaft seal	27	PWB	Hydraulic seal	86	TICLA	Hydraulic seal	68
ECOR	Hydraulic seal	96	HS5	Radial shaft seal	27	PWF	Hydraulic seal	88	TIL	Hydraulic seal	68
G	Hydraulic seal	58	HS6	Radial shaft seal	27	PWY	Hydraulic seal	86	UN	Hydraulic seal	70
GA	Hydraulic seal	83	HS7	Radial shaft seal	27	RD10	Radial shaft seal	16	URG	Hydraulic seal	56
GC	Hydraulic seal	58	HS8	Radial shaft seal	27	RD11	Radial shaft seal	16	VR1	Axial shaft seal	45
GG	Hydraulic seal	58	HS9	Radial shaft seal	27	RD30	Radial shaft seal	16	VR2	Axial shaft seal	45
GH	Hydraulic seal	58	HSF1	Radial shaft seal	25	RD60	Radial shaft seal	16	VR3	Axial shaft seal	45
GHT	Hydraulic seal	55	HSF2	Radial shaft seal	25	RD70	Radial shaft seal	16	VR4	Axial shaft seal	45
GH-XX8	Hydraulic seal	58	HSF3	Radial shaft seal	25	RD71	Radial shaft seal	16	VR5	Axial shaft seal	45
GL	Hydraulic seal	58	HSF4	Radial shaft seal	25	RDD13	Radial shaft seal	17	VR6	Axial shaft seal	45
GLC	Hydraulic seal	58	HSF5	Radial shaft seal	25	RDD14	Radial shaft seal	17	Other SKF radial shaft seal types		36
GLG	Hydraulic seal	58	HSF6	Radial shaft seal	25	RDD15	Radial shaft seal	17			
GN	Hydraulic seal	58	HSF7	Radial shaft seal	25	RGR	Hydraulic seal	93			
GR	Hydraulic seal	58	HSF8	Radial shaft seal	25	RI	Hydraulic seal	77			
GS	Hydraulic seal	58	HSF9	Radial shaft seal	25	RSW	Hydraulic seal	87			
GS-XX8	Hydraulic seal	74	LDSL3	Wear sleeve	41	SA	Radial shaft seal	61			
HDDF1	Axial shaft seal	47	LDSL4	Wear sleeve	41	SAARR	Hydraulic seal	61			
HDL	Radial shaft seal	22	M	Hydraulic seal	57	SAW	Hydraulic seal	61			
HDLP	Radial shaft seal	22	MD	Hydraulic seal	57	SB/C	Hydraulic seal	93			
HDS1	Radial shaft seal	23	M-R	Hydraulic seal	57	SBF	Hydraulic seal	26			