



AUTOMATIC PACKERS

4.0 INDUSTRY
compliant



stretch-film packers

OUTPUT*

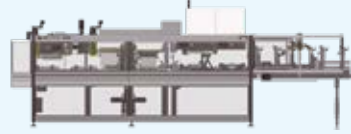

APPROXIMATE SIZE**

SFP 30 ERGON	FILM ONLY	30 PPM	 PAG. 6	6490 x 1774 x 2450 mm	21.30 x 5.82 x 8.04 ft
--------------	-----------	--------	--	-----------------------	------------------------

Shrinkwrappers

OUTPUT*

APPROXIMATE SIZE**

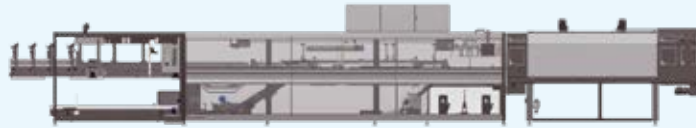
AFW 30 F/P/T ERGON	F= FILM ONLY P= PAD + FILM T= TRAY ONLY TRAY + FILM	30 PPM	 PAG. 8	10060 x 1774 x 2450 mm	33.01 x 5.82 x 8.04 ft	
AFW 40 F/P/T ERGON		40 PPM		10980 x 1774 x 2450 mm	36.02 x 5.82 x 8.04 ft	
LSK SF 30 ERGON	FILM ONLY	30 PPM	 PAG. 10	7672 x 1774 x 2450 mm	25.17 x 5.82 x 8.04 ft	
LSK 30 F/P/T ERGON	F= FILM ONLY P= PAD + FILM T= TRAY ONLY TRAY + FILM	30 PPM		10400 x 1774 x 2450 mm	34.12 x 5.82 x 8.04 ft	
LSK 40 F/P/T ERGON		40 PPM		11320 x 1774 x 2450 mm	37.14 x 5.82 x 8.04 ft	
LSK 32 F ERGON	F= FILM ONLY	60 PPM		9820 x 1974 x 2450 mm	32.22 x 6.48 x 8.04 ft	
LSK 42 F ERGON		80 PPM		9820 x 1974 x 2450 mm	32.22 x 6.48 x 8.04 ft	
CSK 40 F/P/T ERGON	F= FILM ONLY P= PAD + FILM T= TRAY ONLY TRAY + FILM	40 PPM		 PAG. 12	11480 x 1774 x 2450 mm	37.66 x 5.82 x 8.04 ft
CSK 50 F/P/T ERGON		50 PPM	12980 x 1774 x 2450 mm		42.59 x 5.82 x 8.04 ft	
CSK 42 F ERGON	F= FILM ONLY	80 PPM	11480 x 1974 x 2450 mm		37.66 x 6.48 x 8.04 ft	
CSK 52 F ERGON		100 PPM	12690 x 1974 x 2450 mm		41.63 x 6.48 x 8.04 ft	
SK 500 F/P/T ERGON	F= FILM ONLY P= PAD + FILM T= TRAY ONLY TRAY + FILM	50 PPM	 PAG. 14		15815 x 1774 x 2450 mm	51.84 x 5.82 x 8.04 ft
SK 600 F/P/T ERGON		60 PPM			17040 x 1774 x 2450 mm	55.91 x 5.82 x 8.04 ft
SK 800 F/P/T ERGON		80 PPM		18040 x 1774 x 2450 mm	59.19 x 5.82 x 8.04 ft	
SK 502 F/P/T ERGON		100 PPM		17040 x 1974 x 2450 mm	55.91 x 6.48 x 8.04 ft	
SK 602 F/P/T ERGON		120 PPM		18040 x 1974 x 2450 mm	59.19 x 6.48 x 8.04 ft	
SK 802 F/P/T ERGON		140 PPM		19040 x 1974 x 2450 mm	62.47 x 6.48 x 8.04 ft	
SK 1200 F HS ERGON	F= FILM ONLY 0.33 L aluminium cans Triple lane	150 PPM	18752,5 x 1774 x 2450 mm	61.52 x 5.82 x 8.04 ft		
SK 1202 F HS ERGON		300 PPM	18752,5 x 1974 x 2450 mm	61.52 x 6.48 x 8.04 ft		
SK1200F / SK1202F ERGON		450 PPM	18752,5 x 1974 x 2450 mm	61.52 x 6.48 x 8.04 ft		

*Maximum output in packs per minute. The indicated output refers to 3x2 packs of 1.5 L stable containers. **The data relate to T models (if available)

Trayformers without film

OUTPUT*

APPROXIMATE SIZE**

TF 400 ERGON	TRAY ONLY	40 PPM		PAG. 16	6990 x 1774 x 2450 mm	22.93 x 5.82 x 8.04 ft
TF 800 ERGON		80 PPM			11500 x 1774 x 2450 mm	37.73 x 5.82 x 8.04 ft

Cardboard sleeve multipackers

OUTPUT*

APPROXIMATE SIZE**

MP 150 ERGON	CARDBOARD SLEEVES	150 PPM		PAG. 18	9000 x 1774 x 2584 mm	29.53 x 5.82 x 8.48 ft
MP 150 BK ERGON		150 PPM			6000 x 1774 x 2584 mm	19.69 x 5.82 x 8.48 ft
MP 300 ERGON		300 PPM			12000 x 1774 x 2584 mm	52.49 x 5.82 x 8.48 ft

Wrap-around casepackers

OUTPUT*

APPROXIMATE SIZE**

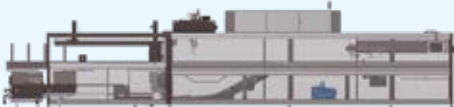
LWP 30 ERGON	WA CASE TRAY	30 PPM		PAG. 20	7490 x 2124 x 2450 mm	24.57 x 6.97 x 8.04 ft
CWP 40 ERGON		40 PPM			9690 x 2124 x 2450 mm	31.79 x 6.97 x 8.04 ft
WP 400 ERGON		40 PPM			11000 x 2124 x 2450 mm	36.09 x 6.97 x 8.04 ft
WP 500 ERGON		50 PPM			11000 x 2124 x 2450 mm	36.09 x 6.97 x 8.04 ft
WP 600 ERGON		60 PPM			12000 x 2124 x 2450 mm	39.37 x 6.97 x 8.04 ft
WP 800 ERGON		80 PPM			12000 x 2124 x 2450 mm	39.37 x 6.97 x 8.04 ft

Combined packers

OUTPUT*

APPROXIMATE SIZE**

LCM 30 ERGON	TRAY ONLY	30 PPM		PAG. 26	13900 x 2124 x 2450 mm	45.6 x 6.97 x 8.04 ft	
LCM 40 ERGON		40 PPM			16100 x 2124 x 2450 mm	52.82 x 6.97 x 8.04 ft	
CM 400 ERGON		TRAY + FILM			40 PPM	18315 x 2124 x 2450 mm	60.09 x 6.97 x 8.04 ft
CM 500 ERGON					50 PPM	18315 x 2124 x 2450 mm	60.09 x 6.97 x 8.04 ft
CM 600 ERGON		CASE			60 PPM	20540 x 2124 x 2450 mm	67.39 x 6.97 x 8.04 ft
CM 800 ERGON					80 PPM	21540 x 2124 x 2450 mm	70.67 x 6.97 x 8.04 ft
CM 400 FP ERGON	FILM ONLY PAD + FILM TRAY ONLY TRAY + FILM CASE	40 PPM	18315 x 2124 x 2450 mm	60.09 x 6.97 x 8.04 ft			
CM 500 FP ERGON		50 PPM	18315 x 2124 x 2450 mm	60.09 x 6.97 x 8.04 ft			
CM 600 FP ERGON		60 PPM	20540 x 2124 x 2450 mm	67.39 x 6.97 x 8.04 ft			
CM 800 FP ERGON		80 PPM	21540 x 2124 x 2450 mm	70.67 x 6.97 x 8.04 ft			

Data here mentioned are subject to changes without any notice.

Features and benefits

ERGON

NEW ERGON RANGE

For the new ERGON range of secondary packaging machines SMI has introduced innovative concepts in terms of ergonomics and modularity which have allowed to further increase the packers' flexibility and considerably facilitate their management and maintenance operations. The new ERGON series - from the Greek word *érgon* meaning "work" - is the outcome of a two-year R&D project which led to notable enhancements concerning the technical configurations featuring SMI secondary packaging machines.



» Slightly-rounded sliding safety guards

The new design entails more room inside the machine, which is used for a more ergonomic and functional configuration of both mechanical and electronic components. Furthermore, the doors are equipped with a safety deceleration device which, by means of a buffer, ensures their soft, final closure.

Advantages: easy access to inner machine's parts; highly safe access for the operator.

» Low energy consumption motors easy to be reached

Thanks to larger room inside the machine, made possible by the rounded safety guards, motors can be installed externally on the edges of the machine. Moreover, SMI packers are actuated only by brushless motors (controlled by digital servo-drivers, which in most cases are integrated into the motor), directly connected to transmission axles.

Advantages: motors and their components are easier to be accessed for reactivation and maintenance operations; the absence of geared motors entails more efficient and precise movements, reduced energy dissipation, low noise level and wear of components.



» Motorized products unscrambler at the machine's inlet

Device made up of a group of oscillating guides which accurately convey loose containers toward the machine's inlet.

Advantages: smooth feeding of the products to be packaged.



» Products separation bars

The pack formation system is equipped with products separation bars made of thermoplastic material or metal ensuring a smooth and constant production process without abrupt movements.



Advantages: lower wear if compared to metal bars, low machine's noise level, protection of fragile containers (for example glass containers) and labels.

» Curved cardboard climb

The initial and final part of the cardboard climb is slightly curved, so as to ensure an easier transfer of the cardboard blank from the magazine to the work surface area.

Advantages: interruption-free packaging process.



» Film unwinding by brushless motor

Highly-precise film unwinding thanks to a brushless motor for each film reel (except AFW/LSK/CSK/LCM).

Advantages: the absence of mechanical reductions ensures more precision and low maintenance costs.



» Film-tensioning system

The system is actuated by a piston, ensuring a constant film tensioning.

Advantages: this new solution enables to pass easily and quickly from a packaging in single lane to a packaging in double/triple lane.

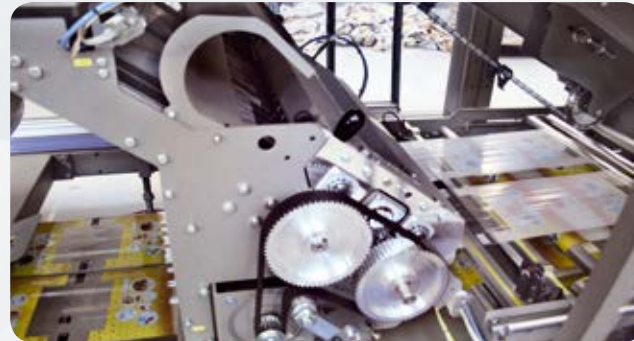

» Direct drive film cutting device

SMI packers are equipped with a blade driven by a direct-drive brushless motor enhancing the film cutting operation and simplifying the motor's maintenance operations.

Advantages: more precise film cutting operations; reduced maintenance operations; low noise level; low energy dissipation; easily accessible blade unit.



» Multi-pitch configuration

SMI machines are arranged to control up to three different machine pitches, without replacing the mechanical components. The working parameters of each pitch are memorized in the POSYC display; the mechanical setting of the product divider, of the cardboard climb, of the tray/case former and of the film wrapper is very easy, thanks to the coloured position indicators installed on the chains.



Advantages: the dimension range of the products handled is one of the widest on market, thanks to the possibility to pack a large range of containers in a high number of configurations.

» User-friendly man-machine interface

The POSYC control panel, which slides on a track running the whole length the machine (optional on some models), is equipped with an extremely intuitive interface, a touch screen display, diagnostic functions and real-time technical support.



Advantages: easy and efficient use of the machine also by low experienced operators.



UP TO 30 PPM

ERGON

» Stretch-film packers

The SFP series is composed of automatic machines to pack already made bundles and loose containers made of plastic, metal, carton or glass.

- Continuous packaging through a minimum 10-micron thick stretch film.
- Stable and resistant packaging, thanks to the two film webs applied in a criss-cross pattern. Packs in 1 x ... and 2 x ... (short side leading).
- Max. pack size 400 mm H x 400 mm L x 400 mm LS (Leading Side) (according to the product).
- Min. Pack size 100 mm H x 200 mm L x 100 mm LS (Leading Side) (according to the product).
- Lower consumption of packaging material (-30/40 % compared to traditional shrink wrappers).
- Low energy consumption, since the packer is not equipped with a shrink tunnel.
- Great quality/price ratio.



SFP ERGON MODEL RANGE

SFP 30

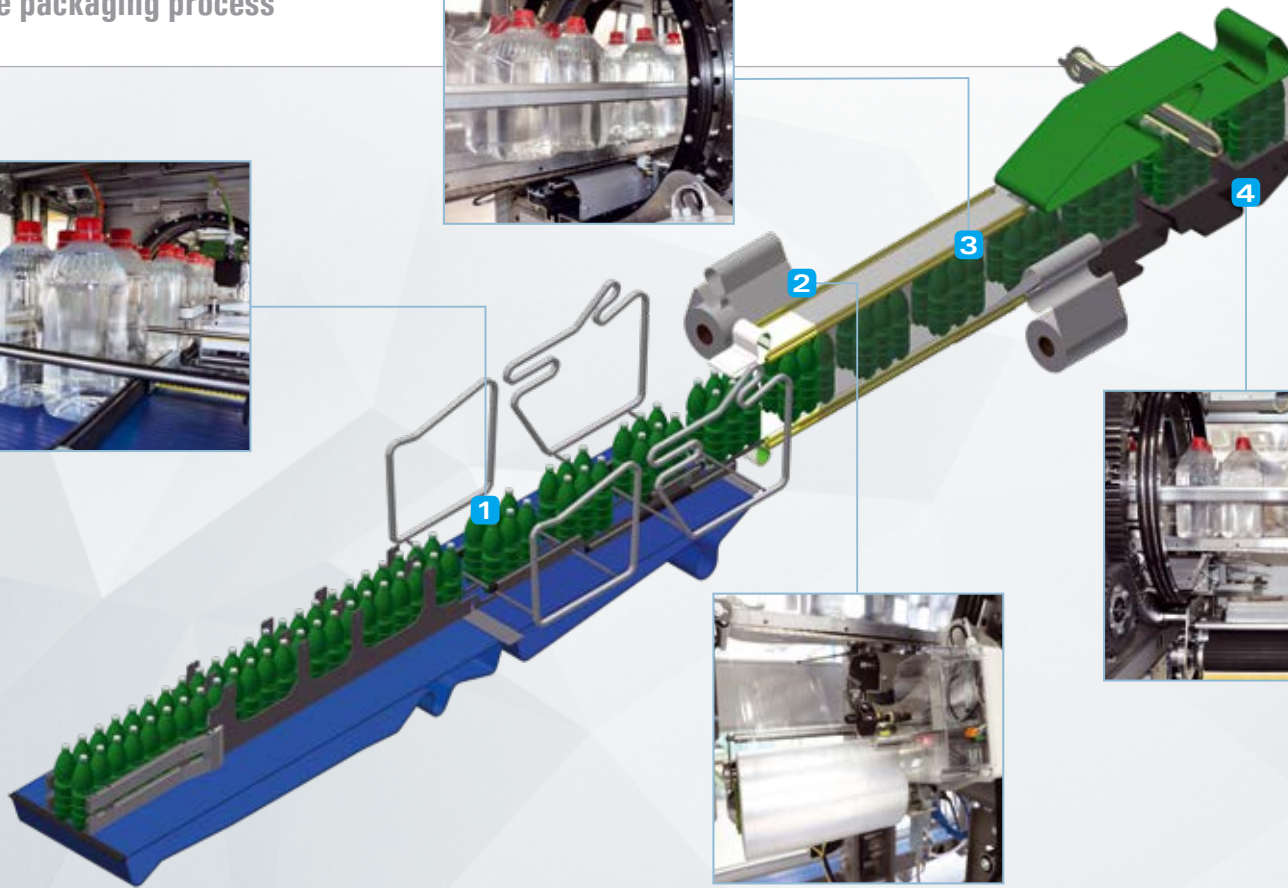

1 At the machine infeed, an oscillating unscrambler accurately lines up the loose containers carried by a conveyor belt featuring low-friction chains made of thermoplastic material. In the pack formation section, the containers are clustered in alternate motion in the required format through a pneumatic device and electronically synchronized separating bars.

2 The film unwinding is operated by brushless motors (one for each of the two reels) for precise and continuous adjustment of the film tensioning (controlled by a progressive brake), which ensures the constant tensioning of the film and allows quick and easy changeover operations.

3 A high-speed film wrapper rotor with counterweigh, controlled by brushless motor, applies two film webs in a criss-cross pattern around the group of containers in transit. The first reel wraps the group of containers in a clockwise direction, while the second one wraps it in a counter-clockwise direction, thus realizing a resistant and long-lasting pack.

4 The machine is equipped with a film-cutting device with resistance-heated vertical blade, controlled by a brushless motors. The 2-step cutting operation is carried out at the front and back of the pack in transit through horizontal movements of the heated blade.



» SFP ERGON: energy saving

Since SFP packers have no heat-shrink tunnel, a substantial saving in power consumption can be achieved during the packaging operation.

Optimized electrical consumption of the motors

The new ICOS motors mounted on the SFP ERGON are equipped with built-in digital servo-driver, with the advantage of simplifying the machine wiring since the servos are no longer installed in the electrical cabinet. This new solution allows to generate less heat inside the electrical cabinet; as a result, the air-conditioning system is not required for temperatures up to 40 °C, thus reducing the power consumption of the facility.





UP TO 40 PPM

ERGON

» Low-medium speed shrinkwrappers

The AFW ERGON series is composed of automatic shrink wrapping machines to pack loose plastic, metal, cardboard or glass containers featuring a rectangular/square bottom (also oval or cylindrical by means of an ancillary device) and/or already made packs. All AFW ERGON models are equipped with a 90° product infeed conveyour and with a mechanical grouping system featuring a push-in device that slides on a brushless motor-driven linear guide. Depending on the model chosen, they can make packs in film only, cardboard pad + film, cardboard tray, cardboard tray + film. AFW packers achieve an output rate up to 40 packs per minute, according to the machine model and the type of product to be handled. Pack collations can vary according to the container shape, capacity and size: the most requested collations are: 2x2, 3x2, 4x3 and 6x4.



AFW ERGON MODEL RANGE

- | | | | | |
|----------|---|----------|---|----------|
| AFW 30 F | ⋮ | AFW 30 P | ⋮ | AFW 30 T |
| AFW 40 F | ⋮ | AFW 40 P | ⋮ | AFW 40 T |

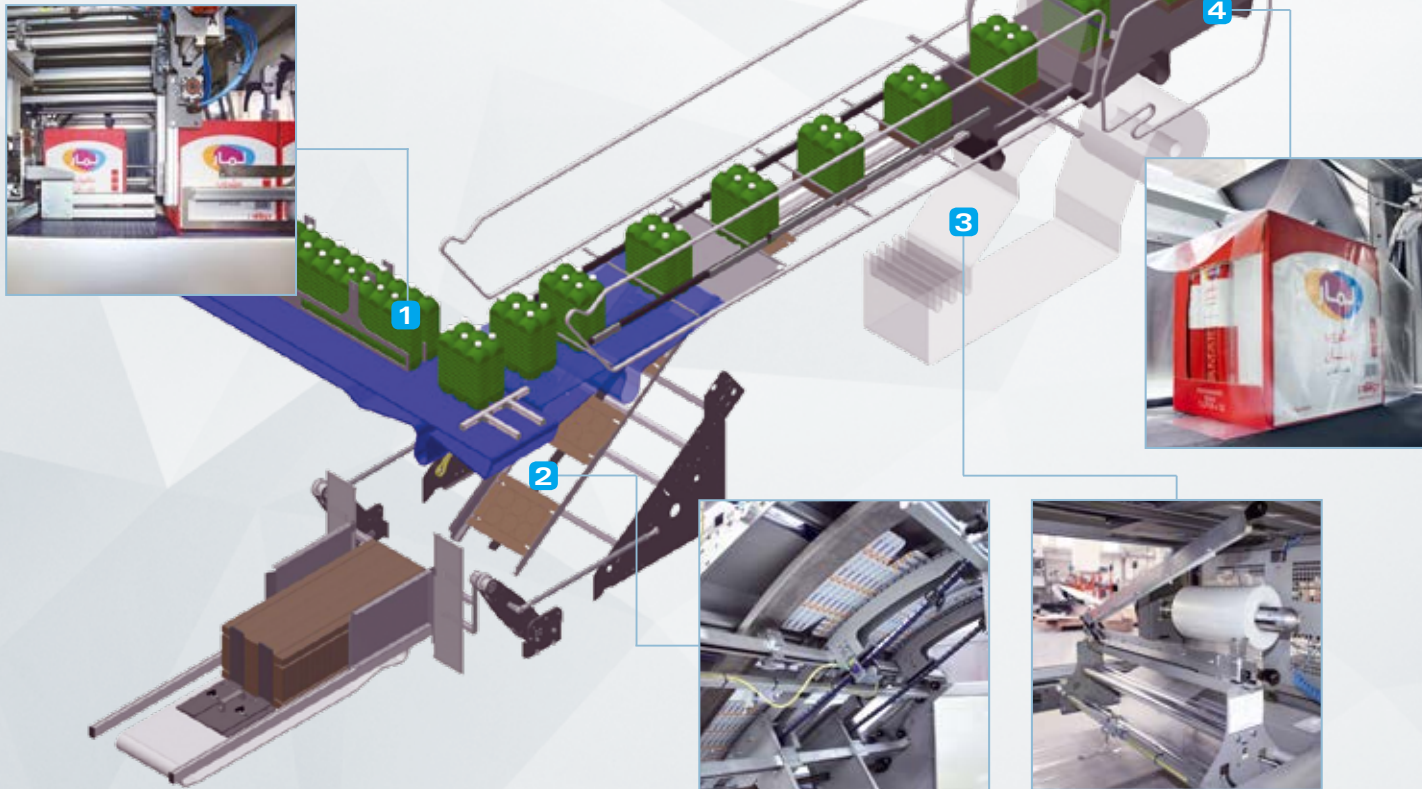

1 An 90° product infeed conveyour, equipped with low-friction chains made of thermoplastic material, carries loose containers or already made packs to the pack formation zone, where the containers are clustered in the required format through a mechanical system made up of a pneumatic press and a product push-in device that slides on a brushless motor-driven linear guide.

2 In P and T models, a corrugated cardboard pad or blank is picked from the blanks magazine by an alternate motion picker composed of a group of vacuum suckers. The pad or the blank moves along the blank climb and gently places itself underneath the group of products in transit with the long side leading.

3 In the trayformer, special mechanical devices fold the blank's front and rear flaps. The side flaps are sprayed with hot melt glue and then folded, thus forming the tray.

4 The unwinding of the film reel placed in the lower part of the machine is controlled by a progressive brake, which ensures the film constant tension. Before the pack enters the shrinking tunnel, the film is wrapped around the container batch and overlapped at the base of the pack.

» 90° entry for briks, packs and unstable containers

The AFW (Angular Film Wrapper) ERGON series was designed to provide users with an ad-hoc machine capable of packaging rigid containers featuring a rectangular or square bottom, such as briks, or already made packs/bundles in "pack-in-pack" configurations. AFW shrinkwrappers can be equipped with optional accessories to pack cylindrical containers as well. To smoothly and continuously process unstable or odd-shaped containers such as paperboard briks the packaging machine entry has to be laid at 90 degrees with respect to the product infeed conveyour; such a configuration allows to prevent hitches or jammings in the loose product flow.





UP TO 40 PPM

ERGON

» Low-medium speed shrinkwrappers

The LSK series is composed of automatic machines to pack plastic, metal, cardboard or glass containers.

Depending on the model chosen, they can make packs in film only, cardboard pad + film, cardboard tray, cardboard tray + film.

LSK packers achieve an output rate up to 40 packs per minute (40*40 in the double lane only film version), according to the machine model and the type of product to be handled.

Pack collations can vary according to the container shape, capacity and size; the most requested collations are: 2x2, 3x2, 4x3 and 6x4.

All LSK machines are equipped with a mechanical product-grouping system and a manual change-over system.

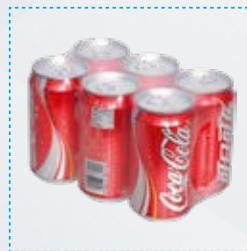

LSK ERGON MODEL RANGE

LSK 30 F	LSK 30 P	LSK 30 T
LSK 40 F	LSK 40 P	LSK 40 T
LSK 32 F		
LSK 42 F		

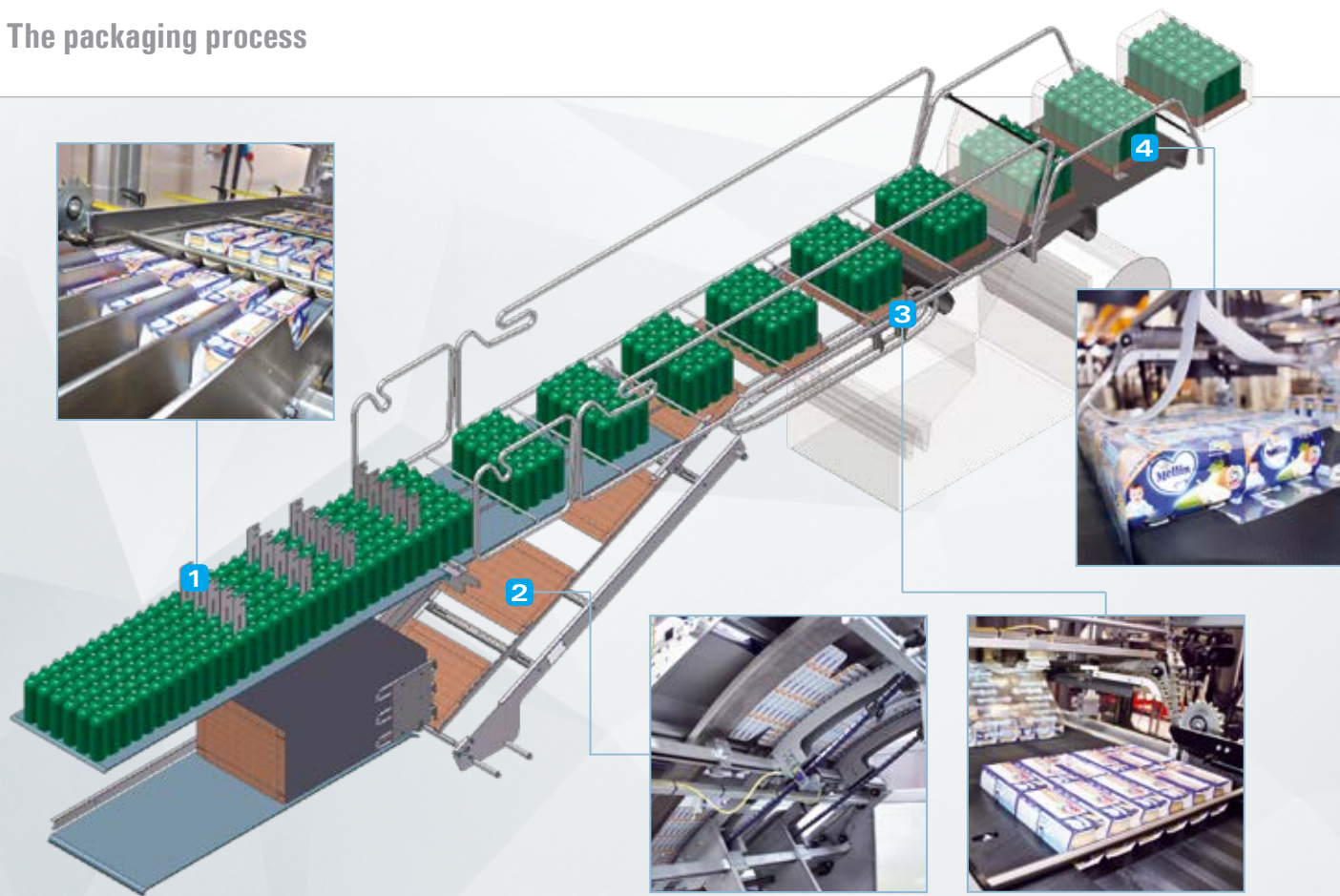

1 At the machine infeed, an oscillating unscrambler accurately lines up the loose containers carried by a conveyor belt featuring low-friction chains made of thermoplastic material. In the pack formation section, the containers are clustered in alternate motion in the required format through a pneumatic device and electronically synchronized separating bars (optional on LSK 30).

2 In P and T models, a corrugated cardboard pad or blank is picked from the blank magazine by an alternate motion picker composed of a group of vacuum suckers. The pad or the blank moves along the blank climb and gently places itself underneath the group of products in transit with the long side leading.

3 In the trayformer, special mechanical devices fold the blank's front and rear flaps. The side flaps are sprayed with hot melt glue and then folded, thus forming the tray.

4 The unwinding of the film reel, placed in the lower part of the machine, is controlled by a progressive brake, which ensures the film constant tension. The film joining operation when the reel runs out takes place by means of a hand-operated sealing bar. Before the pack enters the shrinking tunnel, the film is wrapped around the container batch and overlapped at the base of the pack.

» LSK SF ERGON: Modular and compact structure

- very compact structure since the machine does not have neither the cardboard magazine nor the cardboard climb
- continuous cycle packaging system, by means of a special pneumatic separator (press)
- high reliability of the packaging process
- high quality of the final pack
- film cutting blade activated by direct drive brushless motor
- the packers from the LSK SF ERGON series achieve an output rate up to 30 packs per minute in single lane

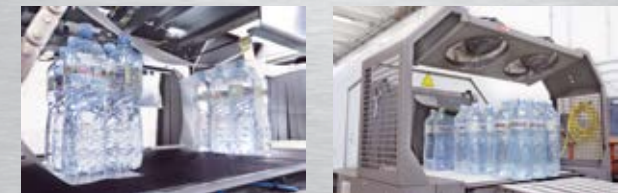
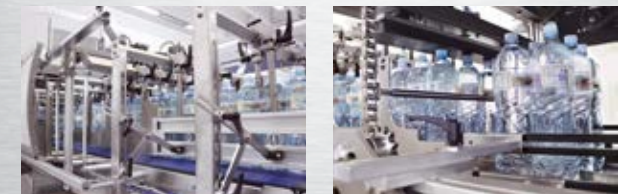



UP TO 50 PPM

ERGON

» Low-medium speed shrinkwrappers

The CSK series is composed of automatic machines to pack plastic, metal, cardboard or glass containers.

Depending on the model chosen, they can make packs in film only, cardboard pad + film, cardboard tray, cardboard tray + film.

CSK packers achieve an output rate up to 50 packs per minute (50*50 in the double lane only film version), according to the machine model and the type of product to be handled.

Pack collations can vary according to the container shape, capacity and size: the most requested collations are: 2x2, 3x2, 4x3 and 6x4. All CSK machines are equipped with an electronic product-grouping system and a manual change-over system.



CSK ERGON MODEL RANGE

CSK 40 F
CSK 50 F
CSK 42 F
CSK 52 F

CSK 40 P
CSK 50 P

CSK 40 T
CSK 50 T

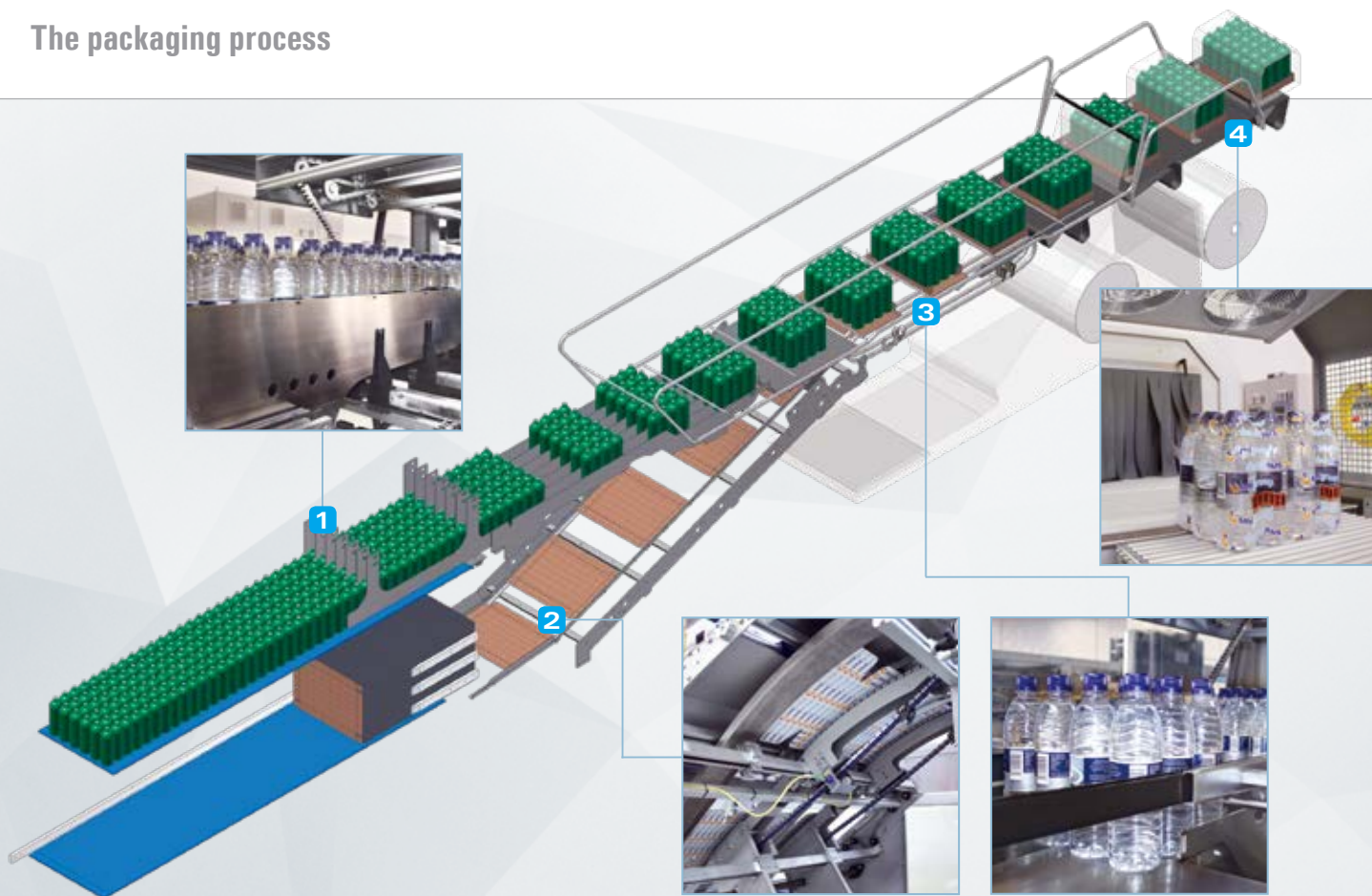

1 At the machine infeed, an oscillating unscrambler accurately lines up the loose containers carried by a conveyor belt featuring low-friction chains made of thermoplastic material. In the pack formation section, the containers are clustered in the required format through electronically synchronized pins and separation bars.

2 In P and T models, a corrugated cardboard pad or blank is picked from the blank magazine by an alternate motion picker composed of a group of vacuum suckers. The pad or the blank moves along the blank climb and gently places itself underneath the group of products in transit with the long side leading.

3 In the trayformer, special mechanical devices fold the blank's front and rear flaps. The side flaps are sprayed with hot melt glue and then folded, thus forming the tray.

4 The unwinding of the film reel, placed in the lower part of the machine, is controlled by a progressive brake, which ensures the film constant tension. Before the pack enters the shrinking tunnel, the film is wrapped around the container batch and overlapped at the base of the pack.

» Fibreglass or metal oven chain

The shrinking tunnel of SMI shrinkwrappers can be supplied with a fibreglass chain (standard supply) or with a metal chain (standard or optional supply according to the machine model):

- the fibreglass retains the heat more efficiently, resulting in an energy consumption reduction. Moreover, the film hardly deposits on the fibreglass
- the metal chain releases more heat, therefore it entails slightly higher energy consumption, but ensures a better film seal under the package

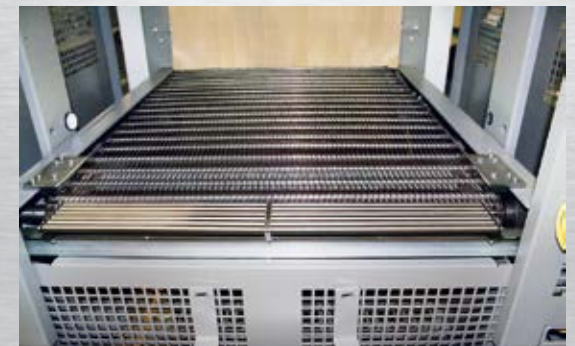



UP TO 450 PPM

ERGON

» Medium-high speed shrinkwrappers

The SK series is composed of automatic machines for packing plastic, metal, cardboard or glass containers.

Depending on the model chosen, they can make packs in film only, cardboard pad + film, tray only, cardboard tray + film. The SK series can achieve an output rate up to 450 packs per minute (on triple lane model), depending on the machine model and on the product to be packaged.

Pack collations can vary according to the container shape, capacity and size.

In general, the most requested collations are: 2x2, 3x2, 4x3 and 6x4. All SK models are equipped with an electronic product-grouping system and are available in single, double and triple lane variants (optional) depending on the customer's requirements.

The SK/F models are equipped with automatic changeover.

SK ERGON MODEL RANGE

SK 500 F	SK 500 P	SK 500 T
SK 600 F	SK 600 P	SK 600 T
SK 800 F	SK 800 P	SK 800 T
SK 1200 HS F		
SK 502 F	SK 502 P	SK 502 T
SK 602 F	SK 602 P	SK 602 T
SK 802 F	SK 802 P	SK 802 T
SK 1202 HS F		

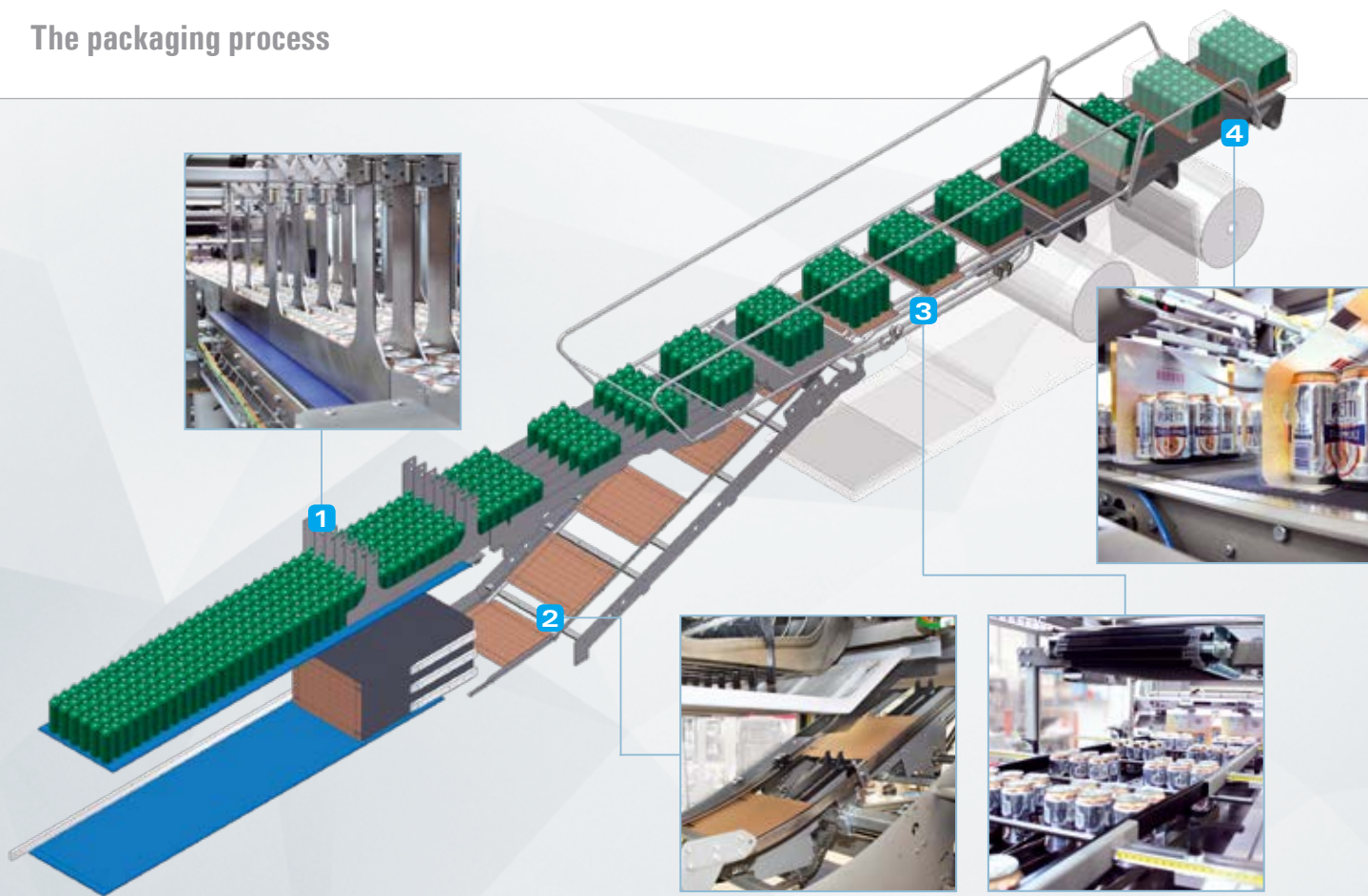

1 In the machine infeed, a group of guides accurately lines up the loose containers carried by a conveyor belt featuring low-friction chains made of thermoplastic material. In the pack formation zone, the containers are clustered in the required format through electronically synchronized dividing fingers and bars, operating in continuous motion.

2 In P and T models, a corrugated cardboard pad or blank is picked from the blank magazine by a rotary picker composed of two groups of vacuum suckers. The pad or the blank moves along the blank climb and places itself underneath the group of products in transit with the long side leading.

3 In the trayformer, special mechanical devices fold the blank's front and rear flaps. The side flaps are sprayed with hot melt glue and then folded, thus forming the tray.

4 The unwinding of the film reels, placed in the lower part of the machine, is controlled by a brushless motor, which ensures the film constant tensioning. The machine is equipped with two reels: one is operating, the other one keeps stopped. When the first reel ends, a manual sealing bar joins the films of the two reels. To facilitate the operation of reel replacement, the machine is outfitted with a special trolley. Before the pack enters the shrinking tunnel, the film is cut by a knife equipped with motorised blade and then wrapped around the group of containers and overlapped on the bottom of the pack.

» Beehive packs

SMI's LSK and SK shrinkwrappers can be equipped with a dedicated device, which arranges the containers (bottles or cans) in staggered alternating rows and keeps them in this manner during the process in which the pack is formed, thereby creating the characteristic beehive collation.

This is a newly-devised packaging solution, which offers considerable advantages in terms of reduced production and palletizing costs since the latter can take place without the insertion of an interlayer between layers, ensuring the customer substantial savings on the purchase of packaging materials.

This is possible thanks to the greater stability and compactness of beehive packs, inside which the containers are "jammed" into one another and where gaps are minimized (contrary to what occurs in traditional and perfectly rectangular packs).

All this allows space optimization on the pallet.



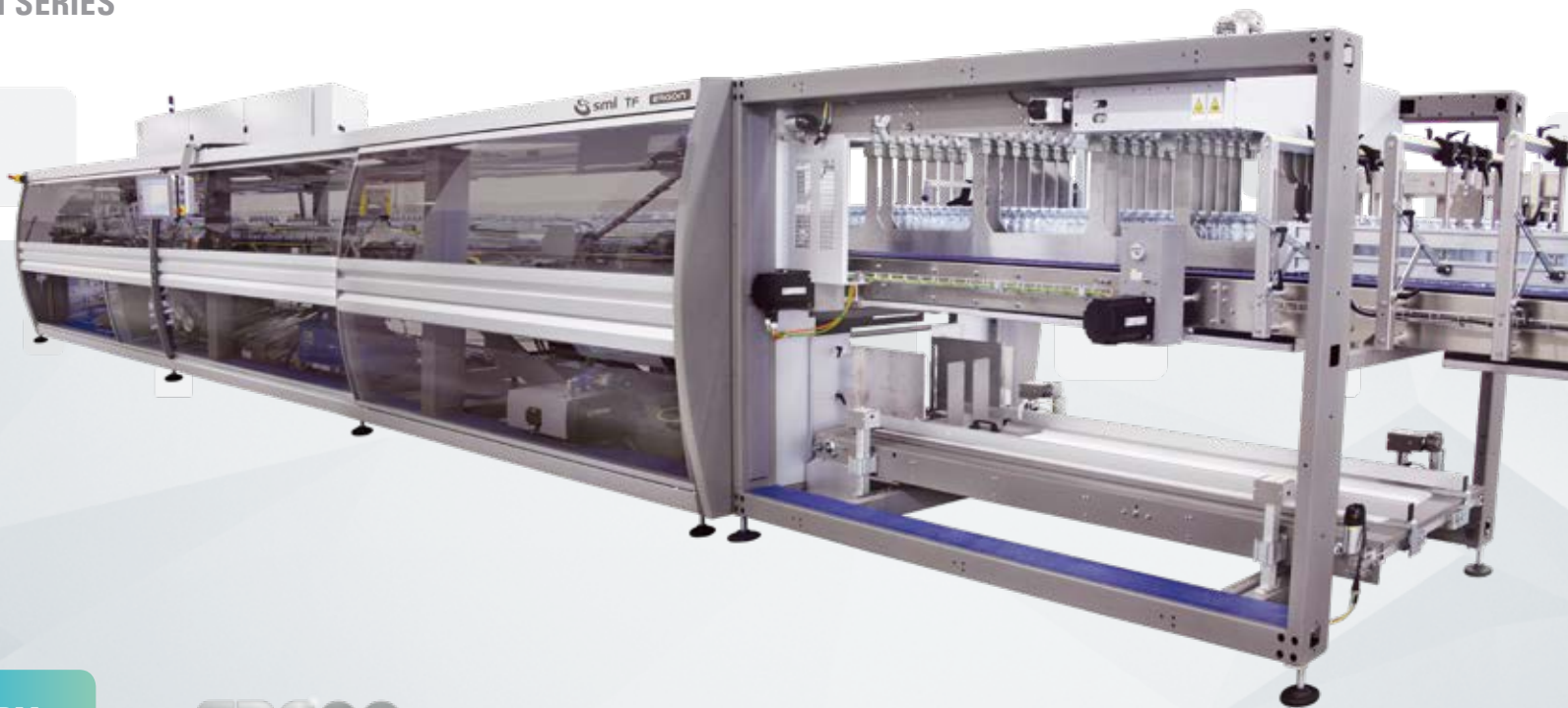

UP TO 80 PPM

ERGON

» Trayformers without film

The TF series includes automatic machines for the packaging of plastic, metal, cardboard and glass containers in cardboard trays without film. Trays can be octagonal or rectangular, with walls measuring the same height.

TF trayformers can achieve an output rate up to 80 packs per minute, according to the machine model and the product to be packaged. Pack collations can vary according to the container shape, capacity and size; in general, the most requested collations are: 2x2, 3x2, 4x3 and 6x4.

The TF800 model features an electronic grouping system (the system is mechanical for TF 400).

TF 800 trayformers can turn into SK shrinkwrappers for the packaging in film at any time, through the insertion of additional modules.

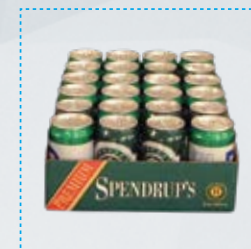

TF ERGON MODELS RANGE

TF 400

TF 800

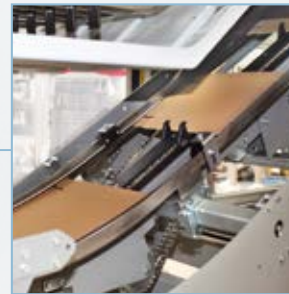
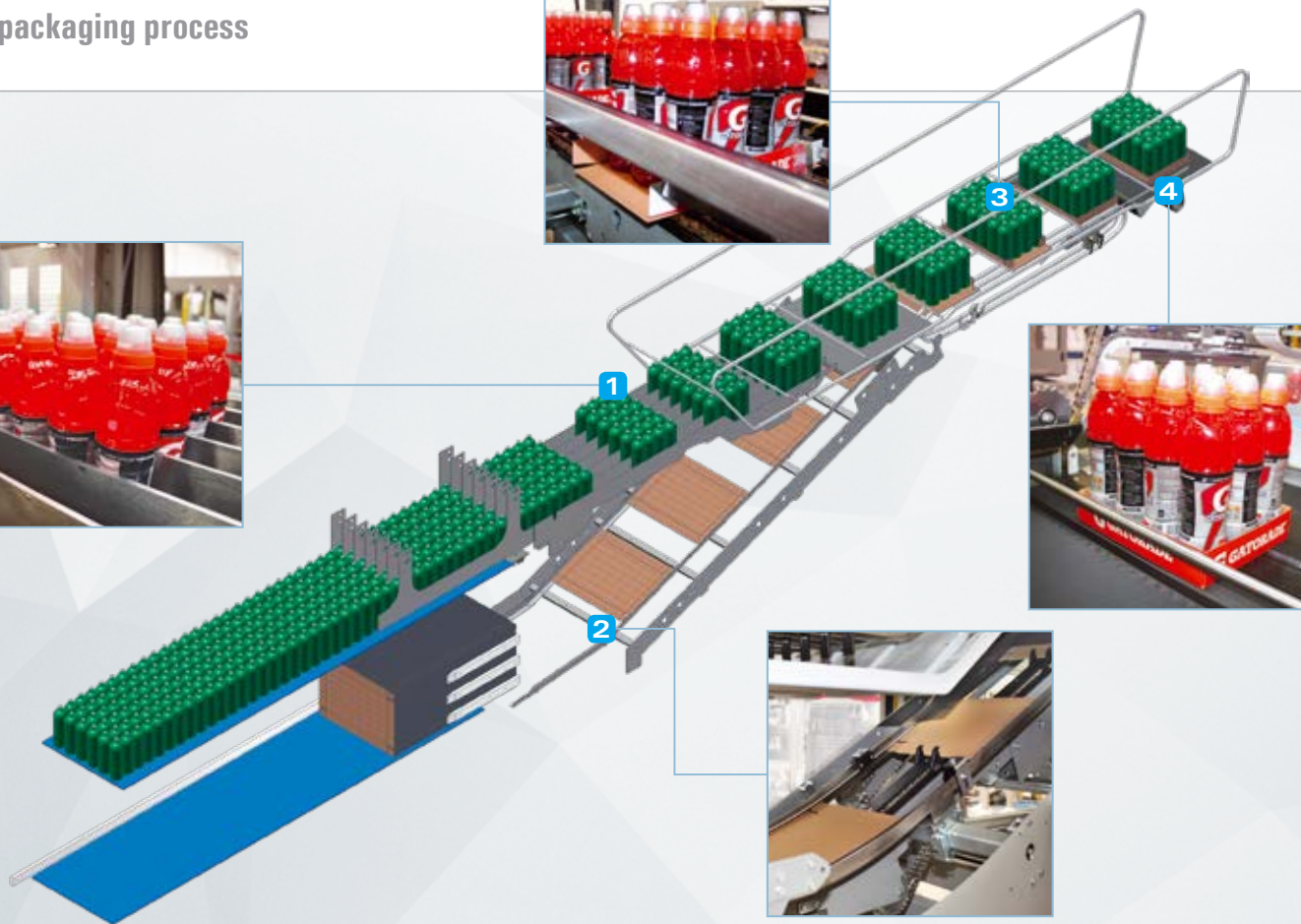

1 TF800 model: at the machine infeed, a group of guides accurately lines up the loose containers or the packs carried by a conveyor belt featuring low-friction chains made of thermoplastic material. In the pack formation section, the containers are clustered in the required format through electronically synchronized dividing rods, operating in continuous motion. TF400 model: the packaging process takes place as described in points 1 and 2 of LSK series.

2 A corrugated cardboard blank is picked from the blank magazine by a rotary picker composed of two groups of electric suction cups. In the TF 400 model the picker operates in alternate mode and is made up of a group of vacuum suckers. The blank moves along the blank climb and gets underneath the group of products in transit with the long side leading.

3 In the trayformer, special mechanical devices fold the blank's front and rear flaps. The side flaps are sprayed with hot melt glue and then folded, thus forming the tray.

4 The packs coming out of the trayformer can be conveyed either to the palletizer or directly to the storage area.

» Trays for all needs

All TF models can pack products in rectangular (1) or in octagonal trays (2).

Therefore, the end user can select the most suitable solution for customizing, distributing and palletizing its packages.

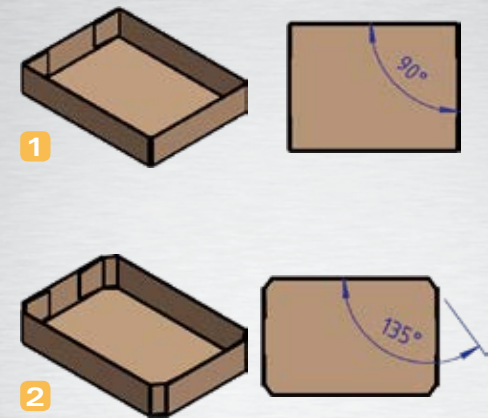



MODEL RANGE

MP 150
MP 150 BK
MP 300

UP TO 300 PPM

ERGON

» **Cardboard sleeve multipackers**

The MP series includes automatic machines for the packaging of plastic, metal, cardboard and glass containers in overlapping cardboard sleeves. MP multipackers can achieve an output rate up to 300 packs per minute, depending on the machine model and on the product to be packaged. Low or medium capacity containers can be packed in OTT (Over The Top) or NT (Neck Through) system. With unusually-shaped products, the pack can be strengthened by adding a top/bottom retaining flap which keeps the containers perfectly steady inside the cardboard sleeve. Pack collations can vary according to the container shape and size; in general, the most requested collations are: 1x3, 1x4, 2x2, 2x3 and 2x4. All MP models feature an electronic grouping system; the change-over operation is manual (also available in the automatic version as a paid accessory).

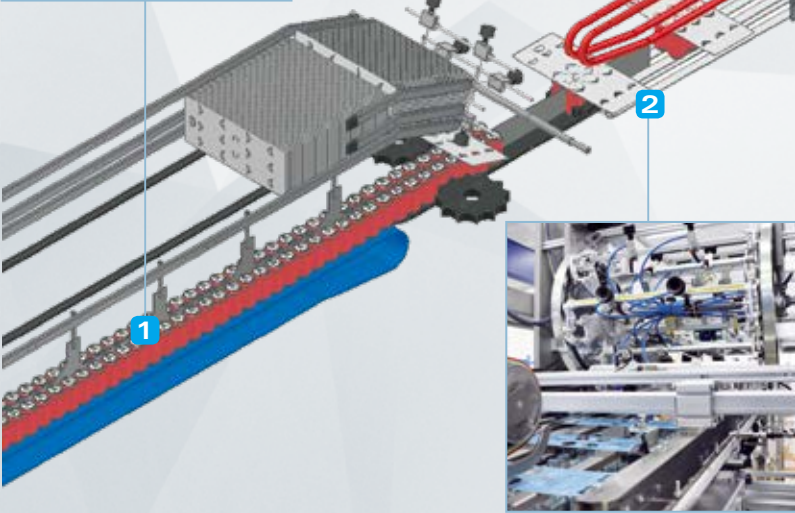

1 On the machine's inlet conveyor belt, featuring low-friction chains made of thermoplastic material, the loose containers arrive already laned in 1 or 2 rows.

2 In the pack formation section, the containers are clustered in the required format through electronically synchronized dividing fingers, operating in continuous motion. At the same time, a cardboard blank is picked from the blank magazine, placed in the upper section of the machine, by a rotary picker operating in alternate motion composed of a group of six vacuum suction cups and placed upon the products in transit.

3 Dedicated mechanical devices fold down the two longest sides of the cardboard blank; then, the pack bottom is sealed with hot melt glue. The choice of a hot melt glue sealing instead of a mechanical tucked-in closure ensures stiffer and steadier packages.

4 Only in the models equipped with the "TR module - translating conveyor at the machine output", the packs at the machine outlet can be positioned on multiple lanes (from 1 to 6) before being conveyed to another packaging machine or directly to the storage area.

» The RD divider

The RD divider is an optional device available on all models equipped with the TR module: it rotates and distributes the packs on multiple lanes. It is available in the electronic and automatic version and can handle both simple and complex patterns, with a maximum inlet speed of 200 packs per minute. The packs coming out of the machine in short side leading can be turned by 90°, in order to change their leading side from short to long.

» "BF - Bottom Flap" module

All models with "BF" module are equipped with a system which forms packs featuring containment flaps at the bottom of the pack, preventing the leakage of containers at the base of the pack.

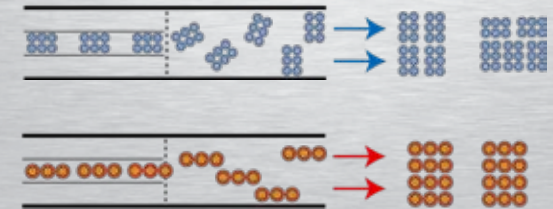



UP TO 30 PPM

ERGON



LWP ERGON MODEL RANGE

LWP 30

» Wrap-around case-packers

LWP series features automatic machines for packing plastic, metal, cardboard or glass containers in corrugated cardboard cases and/or trays without film.

Trays can be octagonal or rectangular, with same or different height edges.

LWP wraparound packers run up to 30 packs per minute, depending on the product handled and on the packing pattern.

Different pack collations can be formed according to the container's shape, capacity and dimensions: the most popular formats on the market are 2x3, 3x4 and 4x6.

LWP packers are equipped with a mechanical product-grouping system and manual format changeover.

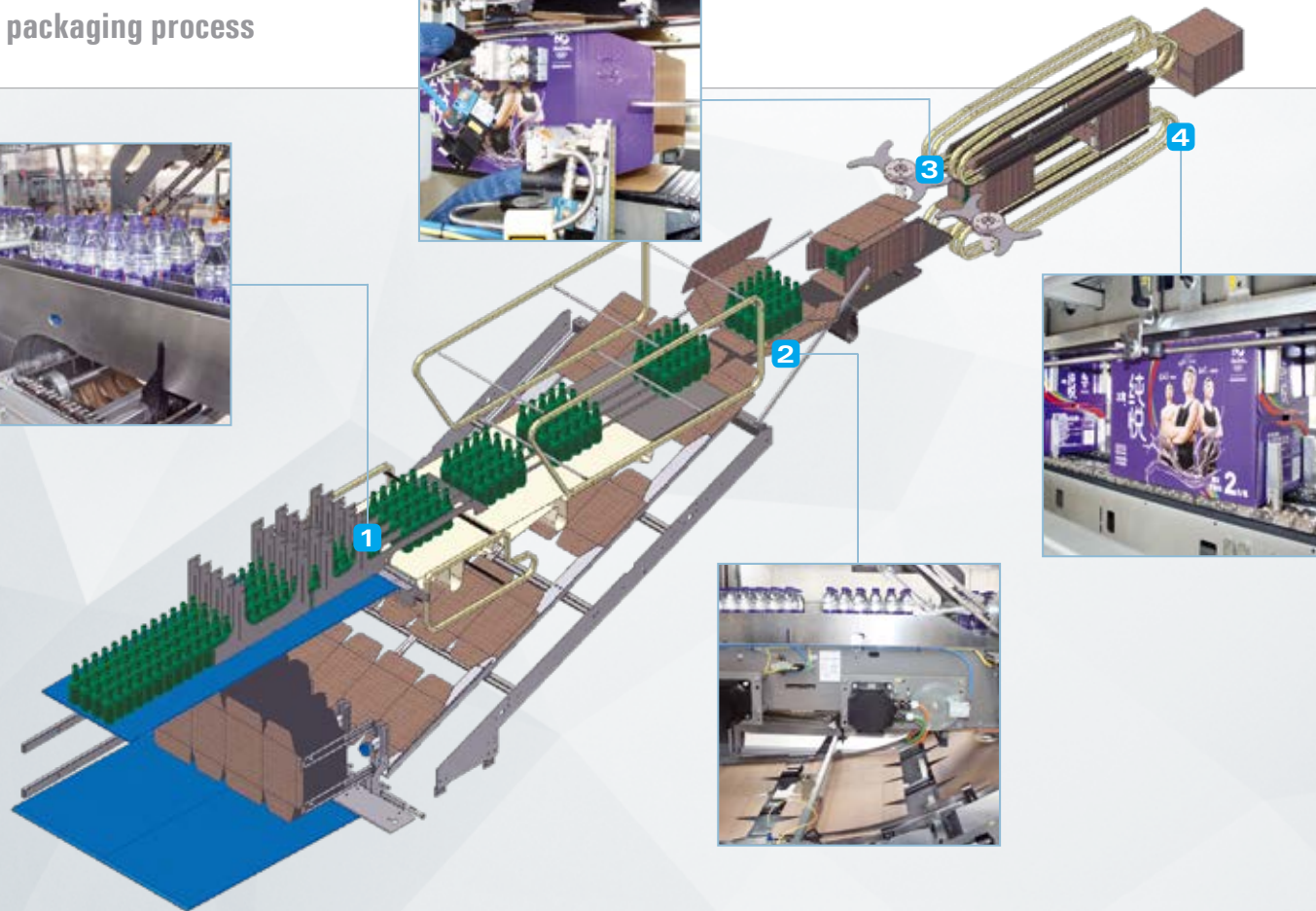

1 At the machine infeed a group of guides lines up loose containers along a conveyor belt featuring low-friction chains made of thermoplastic material. In the pack-forming unit products are grouped in the chosen packing pattern by means of an alternate-motion pneumatic device.

2 A sheet of corrugated cardboard is picked from the blank magazine by an alternate-motion picker with vacuum suction cups; the cardboard blank is then carried up along the blank ramp and positioned under the incoming pack collation with short leading side. The box/tray former operates in continuous motion with wrap-around system.

3 Later on flap-folding devices fold first side flaps and then upper/lower flaps on both the front and the back of the pack. A gun sprays a thin layer of hotmelt glue on the flaps to ensure a perfect endurance of the box/tray.

4 At the machine outlet the case walls are pressed by special guides. Such system ensures perfect and durable pack squaring, if compared to pressing systems with rotating chains, which cannot provide the same quality standard.

» Fridge packs

SMI wraparound packers can pack bottles and cans in pack formats specifically designed to fit into the limited space offered by fridge compartments, therefore named "fridge packs".

Thanks to an innovative design, the box is fitted with a special opening (engraved on the box itself) which allows to pick from the pack only the bottles or cans needed, leaving the remaining ones stored in the fridge.

The box serves as a dispenser for the products gathered in the pack.

Crucial for the realization of this pack is the use of the kraft cardboard which, though it's thinner, ensures a firm packaging.





UP TO 40 PPM

ERGON



CWP ERGON MODEL RANGE

CWP 40

» Wrap-around case-packers

CWP series features automatic machines for packing plastic, metal, cardboard or glass containers in corrugated cardboard cases and/or trays without film.

Trays can be octagonal or rectangular, with same or different height edges.

CWP wraparound packers run up to 40 packs per minute, depending on the product handled and on the packing pattern.

Different pack collations can be formed according to the container's shape, capacity and dimensions: the most popular formats on the market are 2x3, 3x4 and 4x6.

CWP packers are equipped with an electronic product-grouping system and manual format changeover.

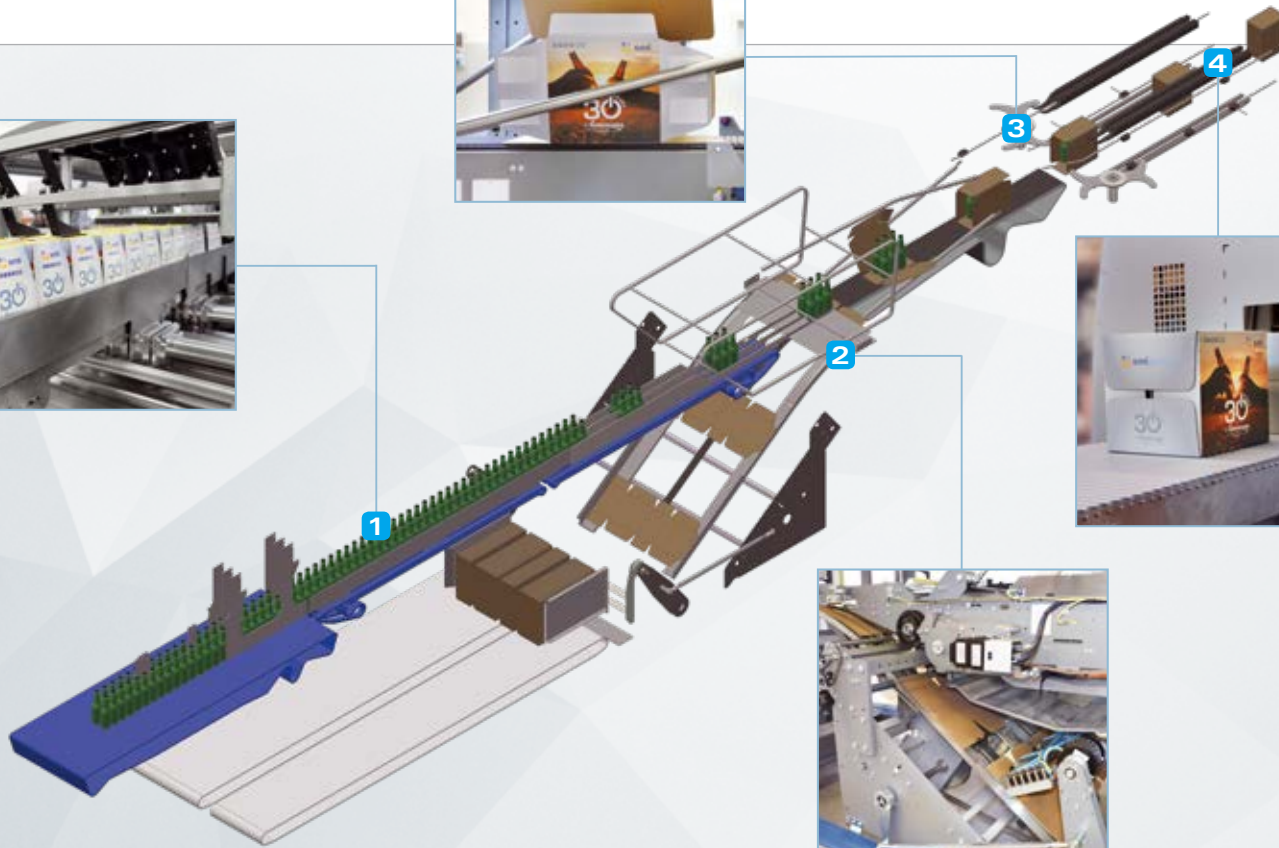

1 On the machine's inlet conveyor belt, featuring low-friction chains made of thermoplastic material, a specific group of motorized oscillating guides accurately lines up the loose containers moving towards the pack formation zone, where the containers are clustered in the selected format through electronically synchronized fingers, operating in continuous motion.

2 A corrugated cardboard blank is picked from the blank magazine (placed underneath the inlet conveyor), by a rotary picker operating in alternate motion composed of a group of vacuum suction cups. The cardboard blank moves along the cardboard ramp and places itself underneath the group of products in transit with the short side leading. The tray/case former features a continuous wrap-around system.

3 In the tray/case former, the cardboard blank is folded and wrapped around the products by means of special guides. The flap folding devices fold the blank's side flaps and then the top/bottom flaps of both the front and back side of the pack. The hot melt glue sealing ensures a very high resistance of the pack.

4 At the machine outlet, the pack walls are pressed by special guides that guarantees a perfect and lasting squaring of the cases. Such system ensures perfect and durable pack squaring, if compared to pressing systems with rotating chains, which cannot provide the same quality standard.

» Wrap-around technology vs. American carton

The wrap-around system provides the following benefits:

- it forms the case around the cluster of containers to be packaged and automatically seals it, while the American carton is formed separately, then filled with containers and lastly sealed
- just a single machine is needed to get the packaging operation completed, whereas the American carton system needs three machines: the first one builds the case, the second one drops the container inside it and the third one seals it
- it allows achieving output rate up to 80 packs/minute, far beyond the output rate of a similarly sized American carton system
- fewer staff is necessary to run the machine and the management and maintenance costs are lower than those of a similarly performing American carton system





UP TO 80 PPM

ERGON



MODEL RANGE

WP 400
 WP 500
 WP 600
 WP 800

» **Wrap-around case-packers**

The WP series includes automatic machines for the packaging of plastic, metal, cardboard and glass containers in corrugated cardboard cases and/or trays without film. The trays can be octagonal or rectangular, with walls measuring either the same height or different heights. The WP casepackers can achieve an output rate up to 80 packs per minute, according to the machine model and to the product. Pack collations can vary according to the container shape, capacity and size; in general, the most requested collations are: 2x3, 3x4 and 4x6. The blank magazine capacity of all WP models can be increased through additional modules. Moreover, all WP casepackers are equipped with an electronic grouping system, manual format changeover and with the "Easy-Load" system to automatically load the cardboard blank magazine.

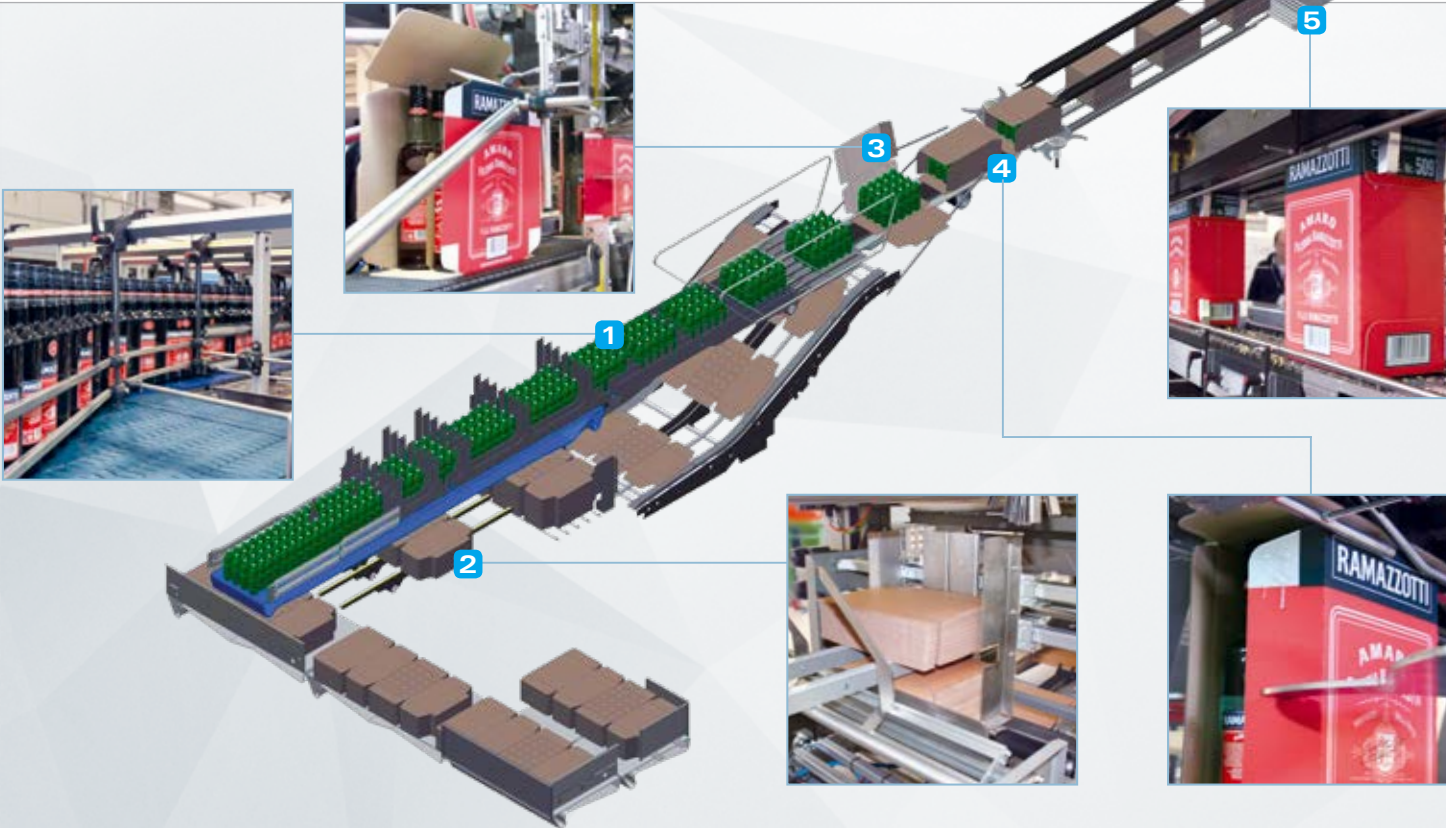

1 On the machine's inlet conveyor belt, featuring low-friction chains made of thermoplastic material, a specific group of motorized oscillating guides accurately lines up the loose containers moving towards the pack formation zone, where the containers are clustered in the selected format through electronically synchronized fingers, operating in continuous motion.

2 The new Easy-Load system automatically loads cardboard blanks into the dedicated blank magazine of the machine. The new loading device is made up of a group of motorized mat-equipped conveyor belts on which the operator easily places the cardboard blanks in uniform horizontal stacks.

3 A corrugated cardboard blank is picked from the blank magazine by a newly designed picker equipped with vacuum

suction cups; then, the cardboard blank is carried up along the blank ramp and positioned under the incoming pack collation with short side leading. The tray/case former features a continuous wrap-around system.

4 In the tray/case former, the cardboard blank is folded and wrapped around the products by means of special guides. The flap folding devices fold the blank's side flaps and then the top/bottom flaps of both the front and back side of the pack. The hot melt glue sealing ensures a very high resistance of the pack.

5 At the machine outlet, the pack walls are pressed by special guides that guarantees a perfect and lasting squaring of the cases.

» Extra-large pack capability

SMI wrap-around casepackers of WP series can be equipped to make form both standard-sized and extra-large cardboard cases or trays as big as ¼ (400x600 mm) or 1/2 europallet (600x800 mm), the so called pallet display.

This solution allows consistent cutbacks on operating costs, if compared to existing systems composed of two machines: one wraparound packer to realize standard 2x3, 3x4, 3x5 and 4x6 pack collations; and one tray-packer to put up to 80 bottles in trays as big as 1/4 or 1/2 europallet.

WP XL wraparound packers also ensure further savings on costs thanks to optimisation of operational and storage areas, lower consumption of packaging materials and reduction of energy costs.

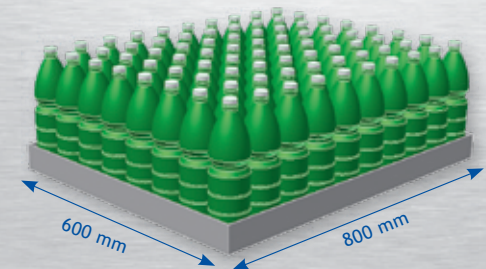
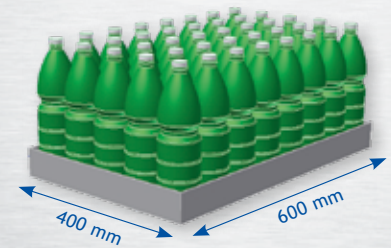



UP TO 40 PPM

ERGON

LCM ERGON MODEL RANGE

LCM 30

LCM 40



» Combined packers

LCM automatic machines combine in one system the functions provided by wraparound packers and shrinkwrappers, for the packaging of plastic, metal, cardboard and glass containers in closed cases, on cardboard pad + film, on cardboard tray + film, and in cardboard tray only. Trays can be octagonal or rectangular, with same or different height edges.

LCM packing machines run up to 40 packs per minute, depending on the product handled and on the packing pattern.

Different pack collations can be formed according to the container's shape, capacity and dimensions; the most popular formats on market are 2x3, 3x4 and 4x6 in closed boxes, 4x3 and 6x4 on tray+film, 3x2 and 4x3 in film only.

LCM packers are equipped with mechanical product-grouping system and manual format changeover.



1 At the machine infeed a motorised oscillating sorter lines up loose containers along a conveyor belt featuring low-friction chains made of thermoplastic material. In the pack-forming unit products are grouped in the chosen packing pattern by means of an alternate-motion pneumatic device.

2 In case of packaging in closed case, on pad or tray, a sheet of corrugated cardboard is picked from the blank magazine by an alternate-motion picker with vacuum suction cups; the cardboard blank is then carried up along the blank ramp and positioned under the incoming pack collation with short leading side (wrap-around case) or long leading side (tray).

3 Depending on the packaging features, in the case/tray forming unit the cardboard blank is folded and wrapped around the products by means of special guides. Later on flap-folding devices fold first side flaps and then upper/lower flaps on both the front and the back of the pack. Hot-glue sealing makes the case highly resistant.

4 If set in the packaging program, the film is wrapped around the pack in transit and overlapped on its bottom and then enters the shrink tunnel. The unwinding of film reels - positioned in the lower part of the machine - is adjusted by a progressive brake which provides constant film tensioning.

» Versatile packs

Besides the cases with traditional sealing, the LCM, CM, LWP and WP models can make cases with joining flaps. Cases can be highly customized by printing images on the 5 visible sides, thus becoming an excellent vehicle of product marketing and promotion, and provide as well a higher protection of the case content from dust, insects, dirt, etc.



1) Traditional closure



2) Closure with joining flaps





UP TO 80 PPM

ERGON

CM ERGON MODEL RANGE

CM 400	CM 600	CM 400 FP	CM 600 FP
CM 500	CM 800	CM 500 FP	CM 800 FP



» Combined packers

The CM series includes automatic machines gathering into a single unit the functions of a wrap-around casepacker and of a shrinkwrapper, for the packaging of plastic, metal, cardboard or glass containers in the following package types: cardboard case, cardboard tray + film and cardboard tray only. CM FP models also make pad + film and film only packs. Trays can be octagonal or rectangular, with walls measuring either the same height or different heights. CM machines can achieve an output rate up to 80 packs per minute, according to the machine model, the type of product and the selected format. Pack collations can vary according to the containers shape, capacity and size; in general, the most requested collations are: 2x3, 3x4 and 4x6 for wrap-around cases and 4x3 and 6x4 for tray + film packs. The blank magazine capacity can be increased through additional modules. All CM packers feature an electronic grouping system, manual format changeover and the "Easy-Load" system to automatically load the cardboard blank magazine.

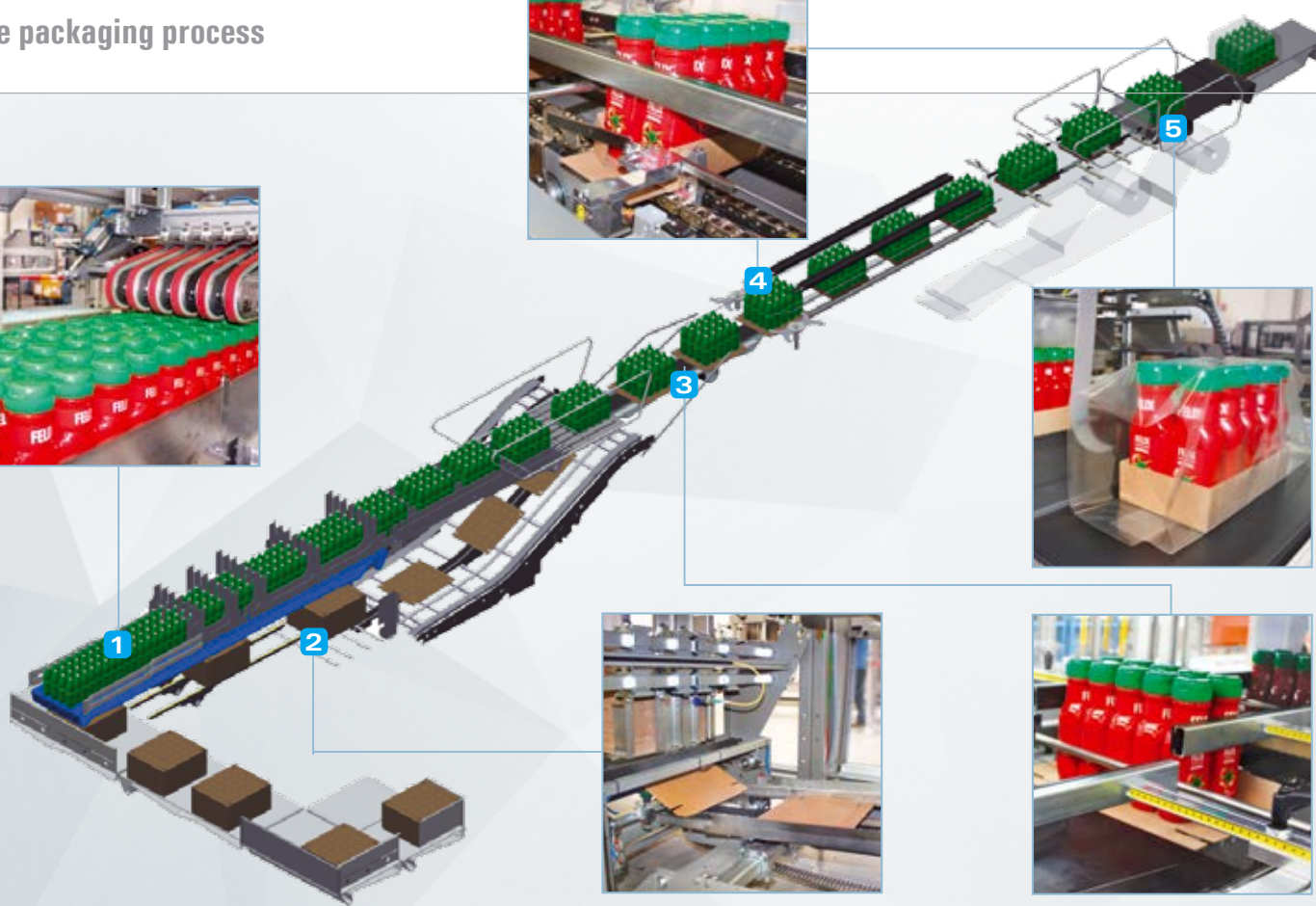

1 On the machine's inlet conveyour belt, featuring low-friction chains made of thermoplastic material, a specific group of motorized oscillating guides accurately lines up the loose containers moving towards the pack formation zone, where the containers are clustered in the selected format through electronically synchronized fingers, operating in continuous motion.

2 The new Easy-Load system automatically loads cardboard blanks into the dedicated blank magazine of the machine. The new loading device is made up of a group of motorized mat-equipped conveyour belts on which the operator easily places the cardboard blanks in uniform horizontal stacks.

3 In case of packaging in cases or trays, a corrugated cardboard blank is picked from the blank magazine by a newly designed picker equipped with vacuum suction cups; then, the cardboard blank is carried up along the blank ramp and positioned under the incoming pack collation with

short side leading. The tray/case former features a continuous wrap-around system. In the tray/case former, the cardboard blank is folded and wrapped around the products by means of special guides.

4 The flap folding devices fold the blank's side flaps and then the top/bottom flaps of both the front and back side of the pack. The hot melt glue sealing ensures a very high resistance of the pack. At the machine outlet, the pack walls are pressed by special guides that guarantees a perfect and lasting squaring of the cases.

5 In case of packaging in cases or trays with film, the unwinding of the film reels, located in the lower part of the machine, is controlled by brushless motors, in order to ensure a constant tensioning of the film.

» Now featuring also film only

A wide array of packaging solutions is now available with SMI CM FP series.

CM machines are indeed designed to combine in one versatile and flexible system the functions provided by wraparound packers and shrinkwrappers.

A smart investment in a cost-cutting, space-saving solution will result in top-level packages in film only, on tray+film, on pad+film, on tray only, in completely or partially closed box.

While the machine is working in "wraparound case" or "tray only" mode, the shrinking tunnel and the film wrapping unit are automatically disabled by the machine control system.

CM packers are particularly suitable for production lines frequently switching products and formats. What's more, Combi-packers can be easily adjusted to handle new products and packing patterns if required by marketing strategies.



Thermo-shrinking tunnel

ERGON

The shrinking tunnels of the ERGON series feature state-of-the-art technical solutions which reduce energy consumption and offer the maximum environmental compatibility.

They are characterized by innovative design and manufacturing criteria, enabling the combination with a large range of packers according to the output rate and the type of product handled.

Thanks to an accurate analysis of the thermodynamic phenomena generated by the shrinking process, the tunnel manages in an efficient and homogeneous way the hot air flows on the whole surface of the pack, ensuring its high quality.

In particular, in the new ST ERGON range air adjustments have further increased, with the result of a more precise management of heat flows.

Immediately after shrinking, the pack undergoes a cooling process which, by means of a higher number of fans set at regular intervals of one meter each, fix the pack's shape, aesthetic qualities and sturdiness to prevent deformations or damages during the following packaging steps.

At the tunnel outlet a belt joins the tunnel with the conveyors: this connection is ventilated so as to ensure the proper thermal transition of the pack.

The first section of the tunnel's belt is equipped with cleaning brushes which remove the possible residual dirt.

SMI shrinking tunnels are devised for an easy and safe access to the inner parts during cleaning and maintenance operations which, among other things, are much lower thanks to traditional systems.

The new shrinking tunnels of the ST ERGON series feature a small switchboard positioned beneath the outlet belt.



Thermo-shrinking tunnel for bundles of cans

» SMI SK packers can be equipped with a special shrinking tunnel, specifically designed for handling aluminium cans to be packed in film only.

The new tunnel for bundles of cans is fitted with a warm air distribution system which includes added air flows for the side shrinking of the packets in transit: in this way, the shrink film wrapping occurs in a more homogeneous and uniform way at all areas of the pack, allowing for the creation of flawless packages (no wrinkles and folds) even at high speeds.

The temperature inside the tunnel, controlled electronically, is maintained, during the entire working cycle, at the optimal levels established in the production programme, thanks to newly-devised



technical solutions which dramatically reduce heat loss.

The amount of time each spends inside the tunnel is also regulated automatically by the machine control system, which keeps it constant for all processed formats.

If the speed of the shrinkwrapper must vary depending on the selected pack configuration, an appropriate device automatically compensates the difference of shrinkwrapper speed/oven by adjusting the belt between the two modules: this allows for high quality shrinkwrapped packs to be obtained, regardless of the format.

The thermo-shrinking tunnel for bundles of cans is available for packaging operations in single, double or triple lane variants.



» Methan-heated shrinking tunnel

SMI LSK, SK, LCM and CM packers can be equipped with a methan-heated shrinking tunnel, as an alternative to the traditional oven, heated by means of electrical resistances.

Natural gas offers several benefits, if compared to traditional fossil fuels:

- its combustion is smogless and pollution-free;
- it complies with current regulations on environmental protection;
- it allows consistent cutbacks on energy bills in countries where gas is cheaper than electricity.

According to accurate tests performed by SMI engineers, in those countries where gas is available at convenient prices - such as in Italy - the methan heated tunnel provides up to 40% saving on energy bills, if compared to traditional electrically-heated tunnels.



Dividers

ERGON

» DV 250 S ERGON - DV 500 S ERGON series dividers

The distribution of the containers within a production line is made possible by the dividers of the "DV 250 S" and "DV 500 S" series. The DV dividers receive the loose products in single row, divide them into several rows and lane them towards the secondary packaging machines. At present, two models are available:

- alternating motion DV 250 S, with a maximum output of 250 containers per minute (*)
- continuous motion DV 500 S, with a maximum output of 600 containers per minute (*)

(*the outputs are referred to a ø 50 mm PET container).

» Reliability and duration

SMI dividers are made of top-quality materials, ensuring operating reliability and long-term duration. The use of wear-resistant components minimizes the maintenance and cleaning operations, thus reducing the total operating costs.



TS Tray Stacker

» Tray Stacker

The NEW TS (Tray Stacker) stacks on two or more layers clusters of plastic, metal, cardboard or glass containers either clustered in cardboard trays or pad or loose (this latter solution available only for fit-in type cans).

This device can be installed on SK shrinkwrappers, on WP casepackers and on CM combined packers.

It consists of an electronic stacking device operating in continuous motion, which achieves an output rate up to 60 packs per minute according to the machine model and to the product handled.

Pack collations can vary according to the container shape, capacity and size; in general, the most requested collations are: 4x3 and 6x4.

It is available both for single and for double lane production.



» Operation

After coming out of the trayforming unit of the packaging machine, two or more layers of containers are stacked by a Cartesian axes coordinate system. Before the pack enters the shrinking tunnel, the film is wrapped around the products and overlapped at the base of the pack.



EASY LOAD

» Automatic loading of the cardboard blanks magazine

The innovative "Easy-Load" system allows the automatic loading of the cardboard blanks magazine and features considerable advantages from an operating and functional point of view; in fact, the operator can easily load the cardboard blanks, stacked horizontally in uniform groups, because the feeding belt of the cardboard blanks magazine is positioned at the same

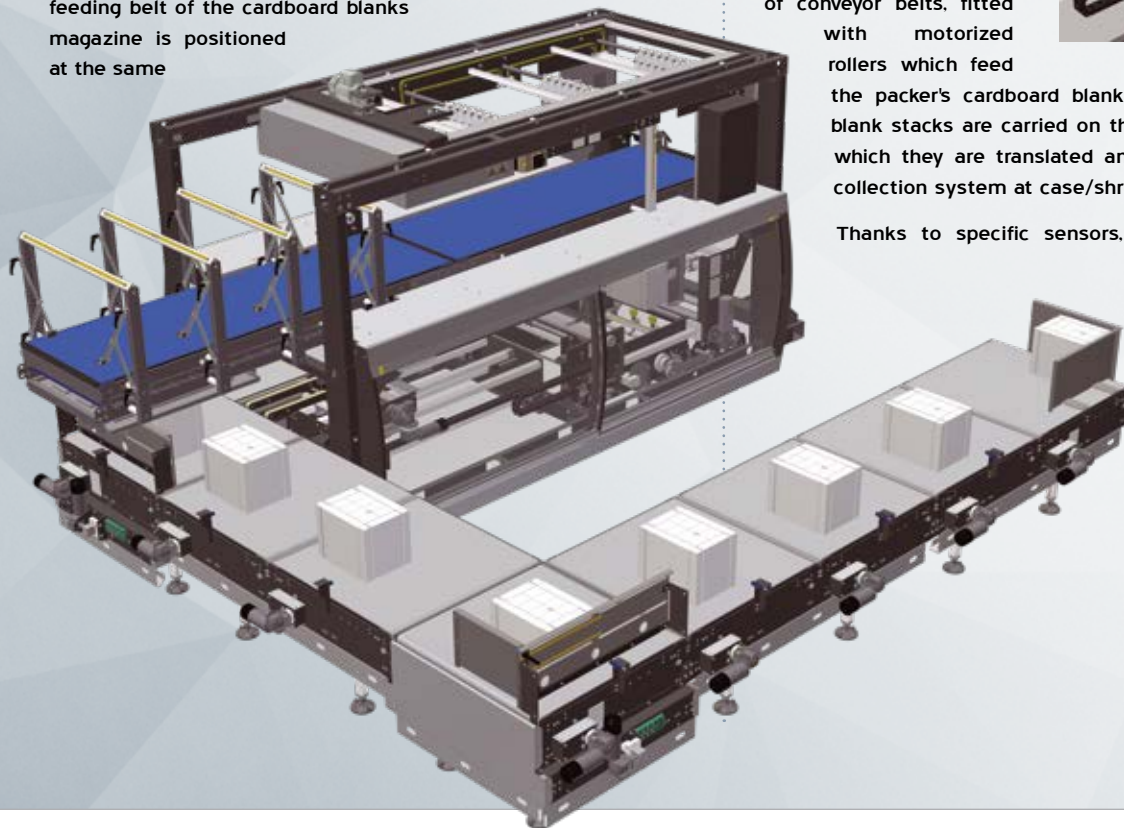

working height as the packer's infeed belt, rather than under it.

In more detail, the new system patented by SMI is made up of a series of conveyor belts, fitted with motorized rollers which feed the packer's cardboard blanks magazine; the cardboard blank stacks are carried on these belts up to the area in which they are translated and then continue up to the collection system at case/shrink packer infeed.

Thanks to specific sensors, both the disposition and feed of the cardboard blanks on the conveyor belts fitted with motorized rollers and their loading into the packer's magazine is, in fact, fully automated.

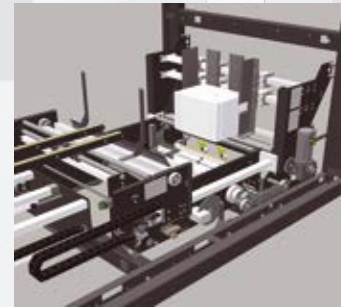

PID SBP®
Partitions inserting device

» Stretched board pre-assembled partition inserting device

The PID SBP® inserts stretched board pre-assembled partitions into cardboard cases, in order to protect fragile products (such as glass containers) and save their labels from abrasions.



This device can be installed on the WP series' wrap-around casepackers and on the CM series' combined packers.

The PID SBP® and the partition magazine are situated at the machine infeed, above the pack formation unit. The maximum output is 40 packs/minute for 1-head model and 60 packs/minute for 2-head models.

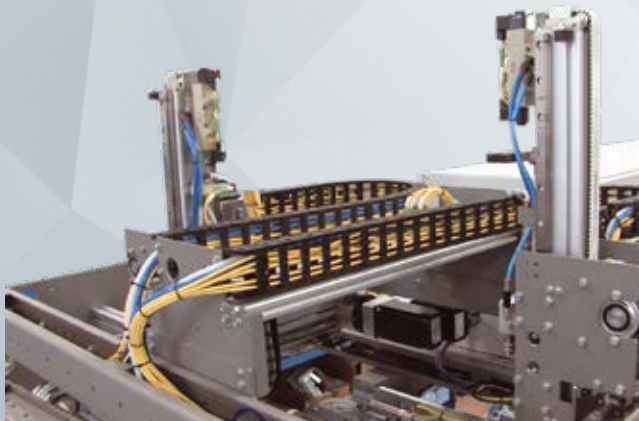

» Advantages

Compared to the traditional inserting systems of cardboard non-preassembled partitions, the PID SBP® allows to:

- reduce the partition purchasing cost by about 20% and the partition storage volume by at least 60%;
- have a more compact machine, since both the partition magazine and the Partition Inserting Device are mounted on the top of the machine; therefore, the machine dimensions are the same as those of a conventional casepacker;
- speed up the partition inserting operation and the magazine loading time, since the partitions are already pre-assembled;
- reduce the effects on the partitions of humidity and climate changes.



» Operation

A mechanical arm equipped with vacuum suction cups picks a stretched board pre-assembled partition from its magazine, opens it and lowers it between the products which have just been grouped in the required pack collation. Finally, a cardboard blank is wrapped around the products by means of special guides, thus forming a case.



PSHA

» Pre-shrinking handle applicator

SK ERGON series shrinkwrappers can be equipped with a PSHA (Pre-Shrinking Handle Applicator) automatic handle applicator to apply handles onto heat-shrinking film before packs are formed and enter the heat-shrinking tunnel.

This optional device is an advantageous solutions for those who don't have enough room to install a stand-alone handle applicator downstream the packer and the conveyor belts connecting the two machines.

The PSHA handle applicator is mounted on the outer edge of SK ERGON shrinkwrappers and, according to the machine's configuration, can be mounted on the operator side or on both sides in case of dual lane operations.

It matches adhesive tape with a non-adhesive central support (a handle made of paper or plastic), thus composing an uninterrupted string of handles which, once wound on a reel, is



loaded on automatically-locking mandrels to be then attached onto the heat-shrinking film surface.

The PSHA handle applicator is perfectly synchronised with the packaging machine on which it is installed; the latter sets automatically in stand-by mode when the handle reel is used up. Two reels can be mounted, one in operation and the other one in stand-by (in dual lane productions four reels are installed: two in operation and two in stand-by); in such a case, a photoeye detects when the reel in operation is running out of handles and turns on an automatic splicing device that joins together the edge of the exhausted tape reel with the edge of the stand-by tape reel, so as to prevent breakdowns in the packaging process. The adhesive handles are precisely applied onto the heat-shrinking film, so that they keep in the right position on the heat-shrunk packs moving out of the tunnel.

The operator panel of the PSHA allows direct modification of the machine parameters, real-time monitoring of the machine state and production data transfer to the user's control system through MODBUS TCP protocol on Ethernet wire. The electrical cabinet is mounted on the top of the handle applicator.

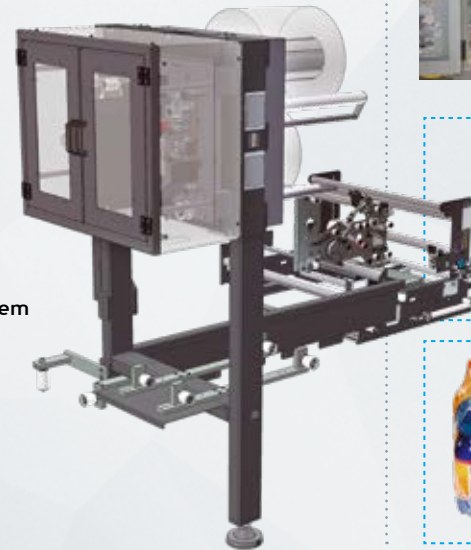

Film welding device by heated blade

SMI customers can now upgrade their SK and CM packers with an innovative film welding device.

The "film welding device by heated blade" joins the edge of the film reel about to end with the beginning of the new reel while the machine is running, with no need to stop production.

The machine slows down and the film (printed or neutral with reference mark) is automatically joined; the machine is immediately back to running at full pace.

The new system allows dramatic cuts on energy and maintenance costs compared to traditional hot sealing method, as there are no more sealing rollers to be kept at a consistent temperature.

The sealing precision of printed film or neutral film with reference mark is higher, with +/-10mm margin from the reference mark.

The "film welding device by heated blade" can handle also no-collant film.

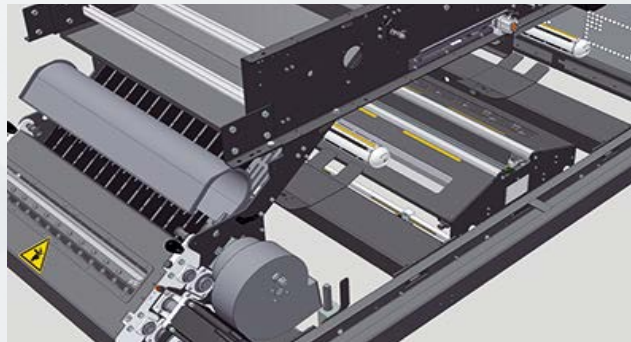
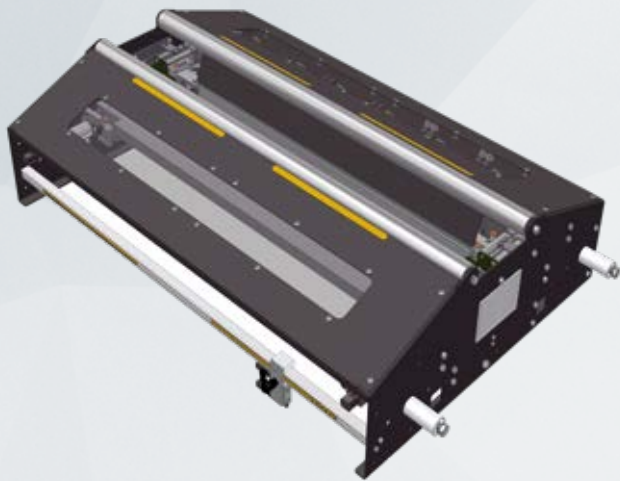

EASY OPEN

» Device for the easy opening of shrinkfilm packs

The Easy Open system can be installed both on SK shrinkwrappers and on CM combined packers.

It consists of a device piercing the film during the cutting operation, in order to create the required mark.

It can pierce two types of marks and is available both for single and for double lane productions.

Advantages

Thanks to the Easy Open system, the customer's level of satisfaction can be remarkably improved, because of the pack's easier opening. Moreover, this application does not require any specific packaging material and, therefore, it is possible to make eye-catching packs without additional costs.

The pack can be opened easily and safely by finger pressure onto a pre-scored opening.



Changeover

Simple and quick transfer from a pack to another.

SMI packers are the ideal solution for the packaging of a wide range of products in several pack collations.

Thanks to a very quick change-over procedure, it is really easy to change the pack format and immediately re-start the production.

The operating parameters of each pack are stored in the POSYC's memory; the operator can select the required format directly from the touch-screen display.

The mechanical adjustment of the machine components might require the operator's manual intervention, depending on the packer model and on the product to be packaged.

On machine models with the manual change-over system, the operator can easily arrange the machine for the new product collation packaging, by means of counting devices and hand-cranks for the guides' adjustment.

On machine models with automatic change-over system, the machine is electronically arranged for the packaging of the new format by means of brushless motors; in most cases, no tool or operator's intervention are needed.

The change-over operation simply consists in the selection of the new format from the POSYC's touch-screen display.

In order to further simplify the shift from a small pack to a large pack or vice versa, SMI packers are set to control up to three different machine pitches, identified by coloured position indicators installed on the chains.



Automatic changeover of inlet guides

SMI packers can be equipped with an automatic adjustment device for product inlet guides, which improves and optimises changeover operations.

The system features DC motors driven by the control PC, which ensure high precision of movement and shorter changeover times for adjusting infeed guides according to the product parameters.

Thanks to the application of this optional device, combined with the automatic adjustment system featured as a standard by the dividing/grouping module, the operator can easily switch formats from the control panel touch-screen display with virtually no manual intervention.



» SMI exclusively manufactures hi-tech packaging machines, featuring modular design, operating flexibility and high energy efficiency, thanks to fully automatic processes, electronically controlled drive shafts and field bus wiring. The hardware and software components are open and modular, complying with the EC regulations and relying upon proven standards of the industrial field and of the packaging sector: OMAC guidelines, SERCOS, PROFIBUS, IEC61131, OPC, Industrial PC, Linux. As a result, referring to guide lines of OMAC (Open Modular Architecture Controls) and to the relevant work group for the packaging sector (OPW= Omac Packaging Controls), SMI machines can guarantee an easy integration with the other machines in the line, a user-friendly technology and the safeguard over time of the capital invested. Moreover, SMI systems are compliant with the technical requirements of Industry 4.0 and IoT (Internet of Things) technologies, which allow to easily and effectively run production lines within a "Smart Factory", even remotely through mobile devices. The automation and control of the machine are managed by the MotorNet System® which, as far as the hardware is concerned, is composed of the following



devices: MARTS (process controller), POSYC (man-machine interface), ICOS (integrated digital servodriver for brushless motors, except SK and WP), dGATE and aGATE (remote IP65 I/O digital/analogic modules). The MARTS is a PAC (Programmable Automation Controller), based on an industrial PC, which can be programmed in IEC61131 languages. The ICOS servodrivers and the dGATE/aGATE I/O modules are connected to the PAC via SERCOS. The POSYC is a control PC with IP 65 touch screen, based on a fanless PC with solid state drives.



SMI automation and control solutions ensure:

- High outputs and high quality packs.
- Constant keeping of control parameters during the whole production cycle.
- Low machine noise.
- Direct control of the machine-serving conveyors, without additional PLC.
- User-friendly technology and easy maintenance.
- Automatic warning on the operator panel's display of programmed maintenance operations to be carried out.
- Quick changeover.
- Possibility of programming machine pitch and drive shafts movement.
- Machine manuals available through the operator panel's memory.
- Machine performance monitoring and down-times analysis (Pareto diagram).
- OPC or MODBUS/TCIP connection for production data collection.
- Tele-assistance by phone or by the internet.
- Easy back up of installation parameters.
- Easy updating of the employed solutions.
- POSYC's interchangeability with compatible PC Panels.
- COSMOS' interchangeability with compatible SERCOS PACK PROFILE servodrivers.
- Access to the operator interface by means of password, pre-arranged USB key and/or biometric fingerprint USB key.



Market segments

- still and carbonated mineral water
- carbonated soft drinks
- tea and energy drinks
- fruit juices
- beer, wine and spirits
- milk, yoghurt and milk-based products
- food and pet food
- edible oil
- detergents, chemicals and pharmaceuticals

Containers suitable to packaging

- bottles
- cans
- jars
- tins
- cartons
- other stiff containers



➤ SFP ERGON max 30 ppm

- 4-way infeed with manual guides + oscillating device to line up loose containers

- product separation by pneumatic press

- vertical cardboard blank magazine

- reciprocating cardboard blank picker

- manually-phased tray-forming unit

- film unwinding controlled by the cutting blade motor

- manual adjustment of the film winder

- Posyc 7" fixed

- standard reel-holder

➤ LSK ERGON max 40 ppm

- 4-way infeed with manual guides + oscillating device to line up loose containers

- product separation by pneumatic press

- vertical cardboard blank magazine

- reciprocating cardboard blank picker

- manually-phased tray-forming unit

- film unwinding controlled by the cutting blade motor

- manual adjustment of the film winder

- Posyc 7" fixed

- standard reel-holder

➤ CSK ERGON max 50 ppm

- 4-way infeed with manual guides + oscillating device to line up loose containers

- product separation by electronically-synchronized push fingers

- vertical cardboard blank magazine

- reciprocating cardboard blank picker

- manually-phased tray-forming unit

- film unwinding controlled by the cutting blade motor

- manual adjustment of the film winder

- Posyc 15" sliding

- standard double reel-holder

➤ SK ERGON max 150 ppm

- 4-way infeed with automatic guides + device to line up loose containers

- product separation by electronically-synchronized push fingers

- vertical/optional horizontal Easy-Load magazine

- rotary cardboard blank picker

- automatically-phased tray-forming unit

- film unwinding controlled by the brushless reel-holder motor

- automatic film winder adjustment

- Posyc 15" sliding

- standard brushless, double reel-holder

➤ **AFW ERGON**
max 40 ppm

- 4-way infeed with product inserter at 90° sliding on a linear guide and driven by a brushless motor

- product separation by pneumatic press + 90° inserter

- vertical cardboard blank magazine

- reciprocating cardboard blank picker

- manually-phased tray-forming unit

- film unwinding controlled by progressive brake

- manual adjustment of the film winder

- Posyc 7" fixed

- standard reel-holder

➤ **LWP ERGON**
max 30 ppm

- Packaging: wrap-around case and tray only

- Infeed with manual guides + oscillating clustering guide device

- 3 way product infeed management

- Alternate cardboard blank picker

- Tray former with manual phasing

- Pneumatic press for product separation

- Vertical blank magazine

- Posyc 7" fixed

➤ **CWP ERGON**
max 40 ppm

- Packaging: wrap-around case and tray only

- Infeed with manual guides + oscillating clustering guide device

- 4 way product infeed management

- Alternate cardboard blank picker

- Tray former with manual phasing

- Electronically synchronised pegs for product separation

- Vertical blank magazine

- Posyc 15" sliding

- Possible PID option – device for inserting cavities

➤ **WP ERGON**
max 80 ppm

- Packaging: wrap-around case and tray only

- Infeed with automatic guides + oscillating clustering guide device

- 4 way product infeed management

- vertical picker with suction cups

- Tray former with automatic phasing

- Electronically synchronised pegs for product separation

- Horizontal "Easy-Load" magazine

- Posyc 15" sliding

- Possible PID option – device for inserting cavities

➤ **LCM ERGON**
max 40 ppm

- Packaging: wrap-around cases, tray only and tray + film

- Infeed with manual guides + oscillating clustering guide device

- 3 or 4 way product infeed management

- Alternate cardboard blank picker

- Tray former with manual phasing

- Product separation: pneumatic press or electronically synchronised pegs

- Vertical blank magazine

- Posyc 15" sliding

- Possible PID option – device for inserting cavities (LCM 40)

➤ **CM ERGON**
max 80 ppm

- Packaging: wrap-around cases, tray only and tray + film

- Infeed with automatic guides + oscillating clustering guide device

- 4 way product infeed management

- vertical picker with suction cups

- Tray former with automatic phasing

- Electronically synchronised pegs for product separation

- Horizontal "Easy-Load" magazine

- Posyc 15" sliding

- Possible PID option – device for inserting cavities

➤ **CM FP ERGON**
max 80 ppm

- Packaging: wrap-around cases, tray only, tray+film, pad+film and film only

- Infeed with automatic guides + oscillating clustering guide device

- 4 way product infeed management

- vertical picker with suction cups

- Tray former with automatic phasing

- Electronically synchronised pegs for product separation

- Horizontal "Easy-Load" magazine

- Posyc 15" sliding

- Possible PID option – device for inserting cavities



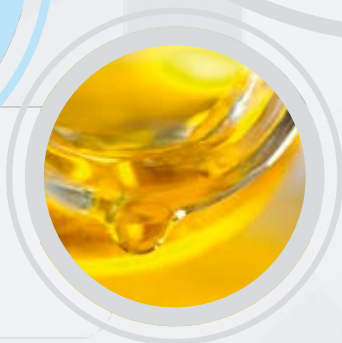
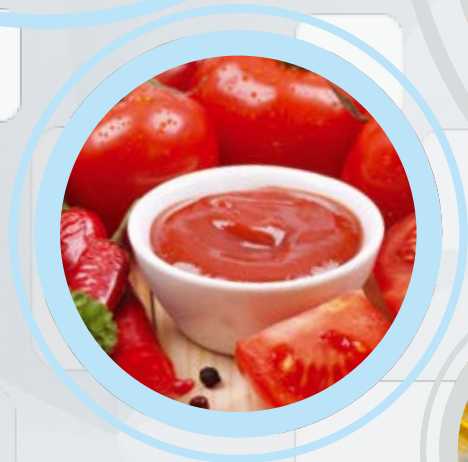

www.smigroup.it



www.smigroup.it



SMI S.p.A.
Via Carlo Ceresa, 10
I-24015 San Giovanni Bianco (BG)
Tel.: +39 0345 40.111
Fax: +39 0345 40.209
E-mail: info@smigroup.it

