

Bakery Industry Conveyor and Processing Belts

Habasit – Solutions in motion

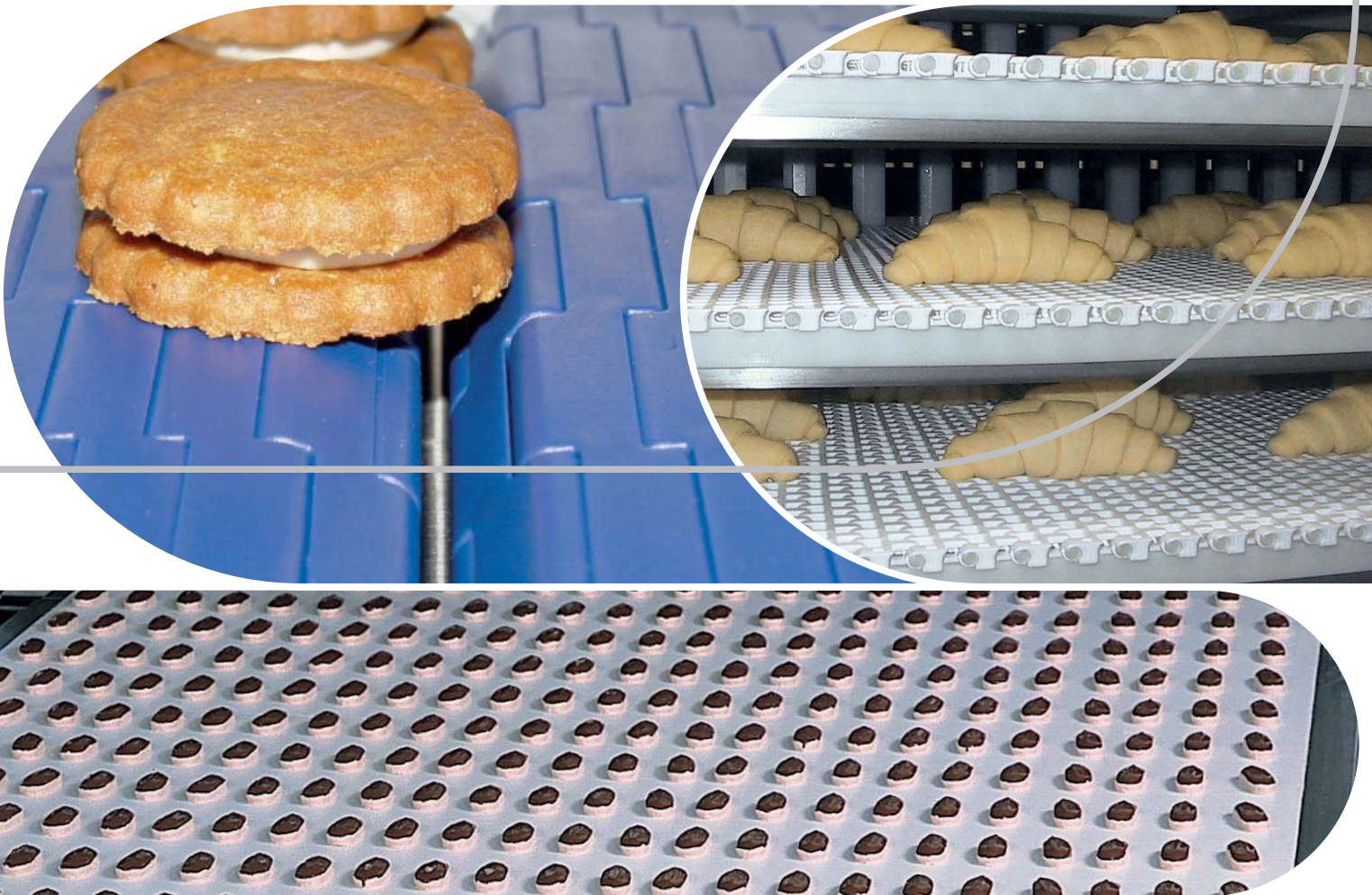

Contents	
Introduction	3
Process overview	4–6
Product ranges	7
Selection of belt surfaces/styles	8
Features and benefits	9
Application table	10–13
Services	14
The Habasit solution	15
Contacts	16

Product liability, application considerations

If the proper selection and application of Habasit products are not recommended by an authorized Habasit sales specialist, the selection and application of Habasit products, including the related area of product safety, are the responsibility of the customer.

All indications / information are recommendations and believed to be reliable, but no representations, guarantees, or warranties of any kind are made as to their accuracy or suitability for particular applications. The data provided herein are based on laboratory work with small-scale test equipment, running at standard conditions, and do not necessarily match product performance in industrial use. New knowledge and experiences can lead to modifications and changes within a short time without prior notice.

BECAUSE CONDITIONS OF USE ARE OUTSIDE OF HABASIT'S AND ITS AFFILIATED COMPANIES' CONTROL, WE CANNOT ASSUME ANY LIABILITY CONCERNING THE SUITABILITY AND PROCESS ABILITY OF THE PRODUCTS MENTIONED HEREIN. THIS ALSO APPLIES TO PROCESS RESULTS / OUTPUT / MANUFACTURING GOODS AS WELL AS TO POSSIBLE DEFECTS, DAMAGES, CONSEQUENTIAL DAMAGES, AND FURTHER-REACHING CONSEQUENCES.



Innovation is a key word at Habasit

Habasit has developed an extensive variety of solutions that allow customers to choose the best product for their application.

Special focus of all developments is on the increasing hygiene standards within the food industry. Habasit offers products that comply with HACCP principles and guarantee trouble-free and safe food production. Beyond this, to provide additional safety, Habasit has introduced unique products such as **HyGUARD®** and **HabaGUARD®** conveyor belts containing antimicrobial additives, Habasit **Cleanline®** food belts coated with a modified polyolefin and **HySAN®**, high oil and fat resistant PVC coated belts.

Special features offer the **TPU non-fray** and **fray-less** belts, which minimize fiber contamination due to their specific fabric construction. Complementary high grade Silicone coated product range.

The extruded positive driven **Habasit Cleandrive™** belts enable performance and hygiene upgrades. Additional products like **HabasitLINK®** plastic modular belts, **HabaCHAIN®** plastic chains, **HabaSYNC®** timing belts and accessories like cleats, edge-sealing profiles and side-walls complete the range.

Habasit is the only belt supplier to manufacture and offer the full package of fabric based and plastic modular belts.

More than 60 years of experience

With a comprehensive global network, Habasit is able to respond to any request that you may have with nothing less than an outstanding belting solution of highest quality, tailored to your specific needs.

Focus on bakery and biscuit processing

Whether handling dough, cooling baked products, molding, cutting or packaging, Habasit offers a complete product range for the bakery, biscuit and snack processing industry.

This includes all kind of fabric belts and modular belts with different surface finish.

Habasit is able to provide dedicated spiral belts for proofing, cooling and freezing. This includes belts for new systems as well as retrofits.

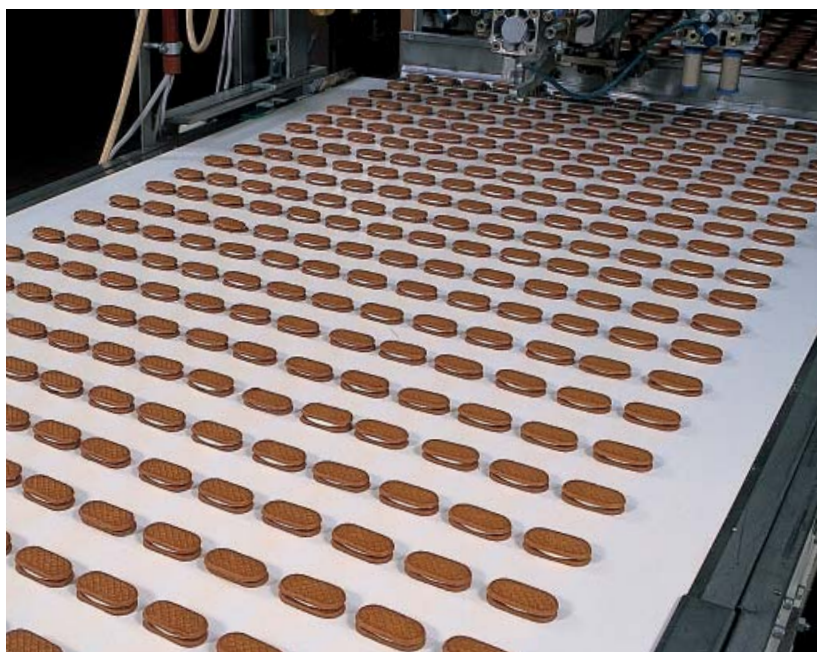



Hearth bread processing

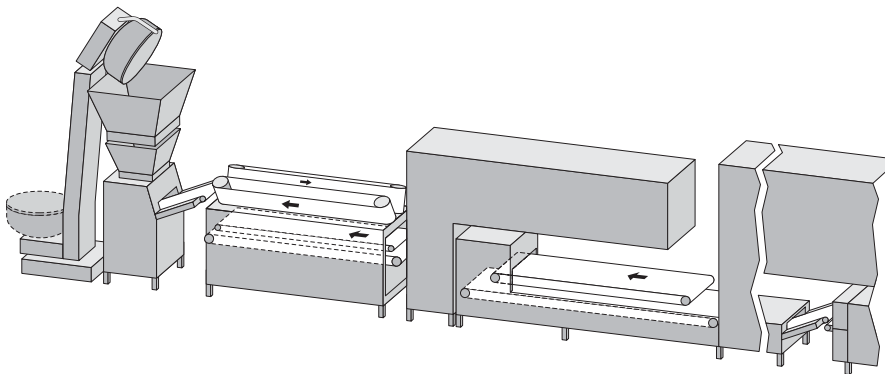

Belt applications

- Dough loader
- Dough divider
- Molder, rounder
- Preproofer
- Final proofer
- Feeding belt
- Round loaf shaping belt
- Cooling conveyor

Bread and bun processing

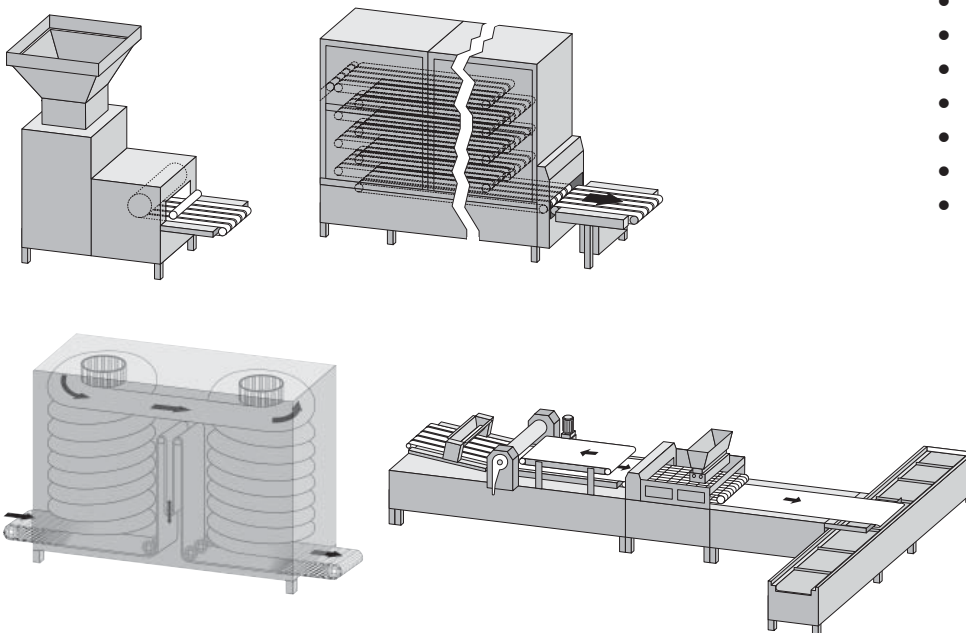

- Dough divider/rounder
- Spreader conveyor belt
- Linear proofer
- Spiral proofer
- Forming station
- Molder belt
- Transfer conveyor belt

Flatbread line

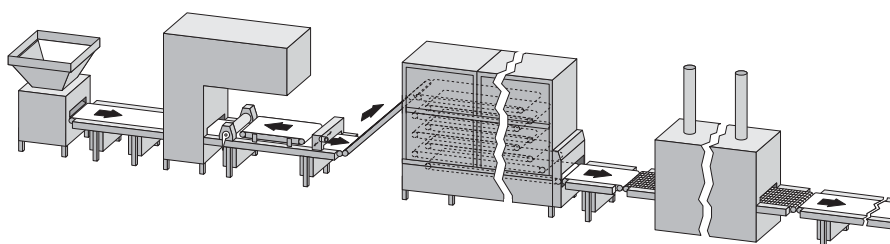

- Dough divider
- Preproofer
- Proofer
- Sheeter belt
- Transfer conveyor belt



Puff pastry dough processing

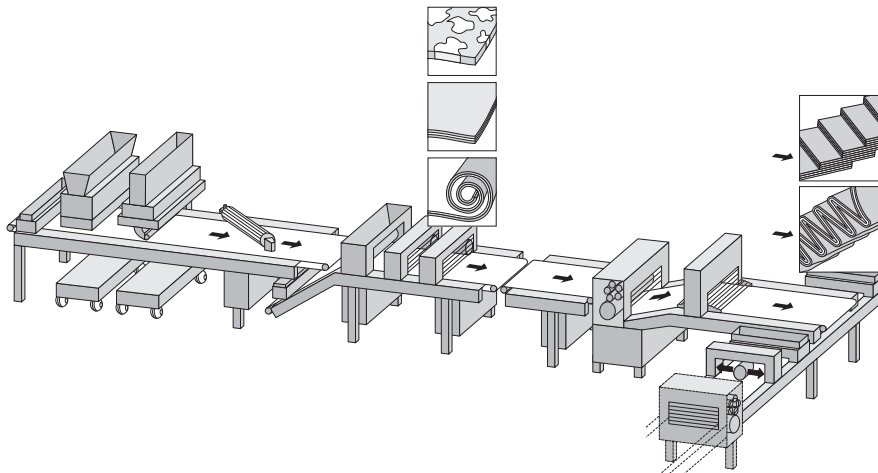

Belt applications

- Dough sheeter
- Shortening extruder
- Curling roller
- Guillotine cutter
- Folding station
- Dough conveyor belt
- Gauge roll
- Crossroller
- Reversing conveyor belt

Biscuits manufacturing

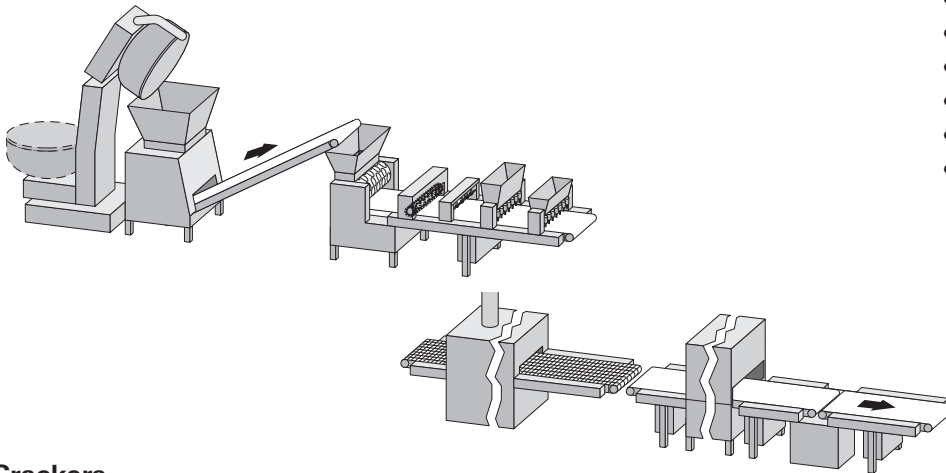

- Dough feeder
- Rotary molder
- Feeding belt
- Functional belt
- Cooling belt
- Transfer conveyor belt

Crackers

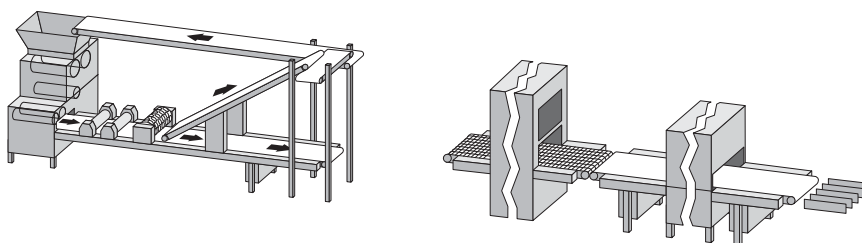

- Laminator for crackers
- Rotary cutter
- Scrap take away/rework system
- Cooling system
- Rework conveyor belt

Remark: The drawings are schematic examples of selected applications/processes. The drawings do not claim completeness. Due to the complexity of various processes, technical requirements and decisive external influences (e.g. nature or property of transported goods, process speed, steps of treatment/handling, environment or process temperature, humidity, chemicals, additives, ingredients, recipes, etc.) there are many possible solutions.



Baked, salty snacks and direct expanded snacks

Belt applications

- Dough sheeter
- Folding device
- Inclined belt
- Transfer belt
- Process belt
- Proofer
- Transfer belt
- Tray loader/unloader
- Spreader belt
- Cooling conveyor

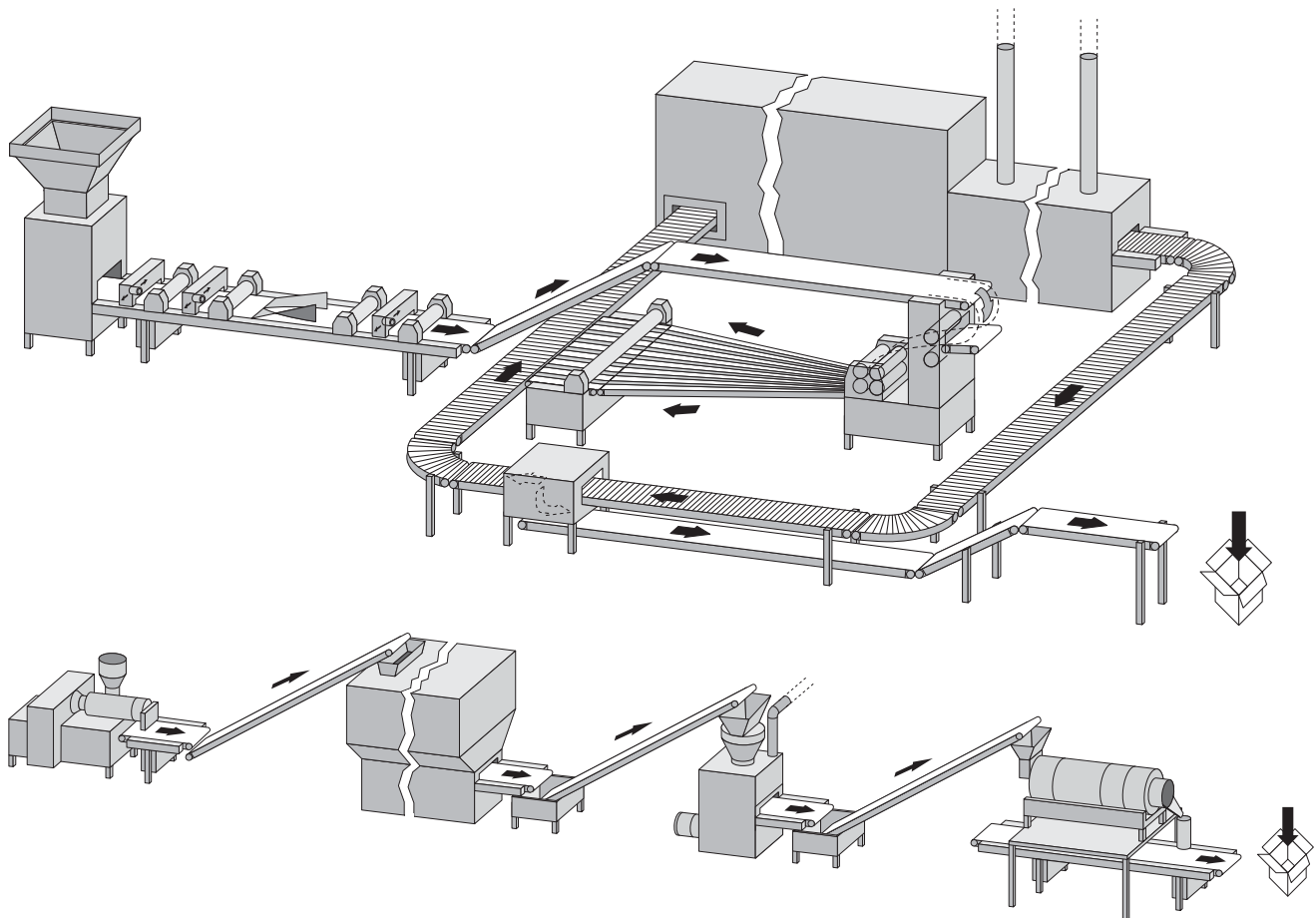

Remark: The drawings are schematic examples of selected applications/processes. The drawings do not claim completeness. Due to the complexity of various processes, technical requirements and decisive external influences (e.g. nature or property of transported goods, process speed, steps of treatment/handling, environment or process temperature, humidity, chemicals, additives, ingredients, recipes, etc.) there are many possible solutions.

The right choice

Habasit has developed an extensive variety of solutions that allow customers to choose the best product for their specific application. Habasit is the only belt supplier to manufacture and offer the full package from fabric based and plastic modular belts to accessories

Fabric-based/coated conveyor belts

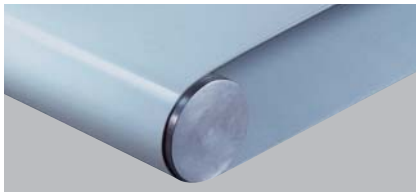

- Fabric surface
- TPU coated
- TPO coated
- PVC coated
- Silicone coated
- Non-woven belts

Plastic modular belts HabasitLINK®

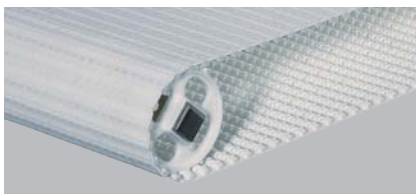

- PP (Polypropylene)
- PE (Polyethylene)
- POM/AC (Polyoxymethylene/Acetal)
- PA and high temperature materials
- Please consult brochures 4128 and 4178

Habasit Cleandrive™

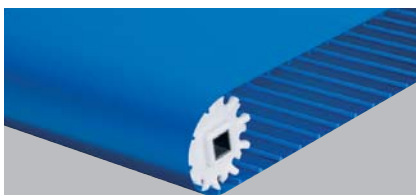

Extruded positive driven and flat conveyor belts made of abrasion- and hydrolysis-resistant TPU, which can be combined with a comprehensive range of accessories.

Please consult brochure 4238

HabaSYNC® timing belts



Polyurethane with steel cord or aramide tensile member.
Belts with special covers

Please consult brochures 4107, 4246 and 4282

HabaCHAIN® slat and conveyor chains



- POM/AC (Polyoxymethylene/Acetal)
- Glass reinforced PP
- Special materials

Please consult brochure 4122

Special solutions

HyCLEAN CIP

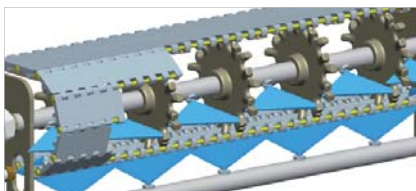

A modular, customized Cleaning-In-Place system (CIP) for the reliable and efficient cleaning of plastic modular belts. (EHEDG certified)

Please consult brochure 4317



Food conveyor belt surfaces

To fulfill a specific process step or a defined function the belt surface plays a key role.

Based on surface structure and material inherent properties a multitude of function possibilities are given.

See below some examples of the large variety of surface structures and properties.

Fabric based belts



Blank surface
(smooth white)



Blank surface
(smooth blue)

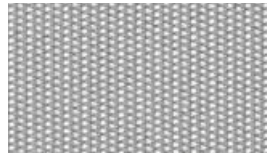

Fabric surface

Available belt surface properties

- **Super adhesive**
- **Adhesive**
- **Medium adhesive**
- **Non-adhesive**



Saw tooth profile
structure



Waffle structure



Quadrillé (quadrangular)
pattern/structure

Plastic modular belts



Flat Top 0.5"

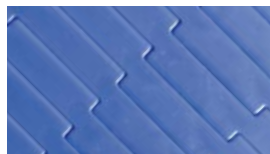

Micropitch Flat Top 0.3"



Flush Grid 0.5"



Radius Flush Grid 1"



Diamond Top 1"

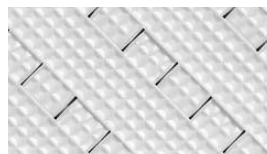

Texture Top 0.5"

Positive drive belts



Habasit Cleandrive™

Timing belts







HabaSYNC®

Round belts

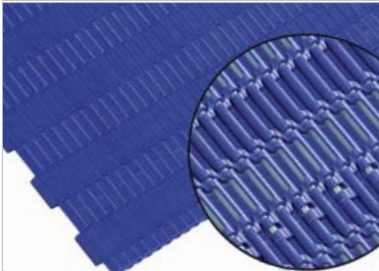

Habiblue

Habasit's belting solutions deliver improved efficiency in conveying and processing, of industrial bakery products.

	Key features	Your benefits
	<p>Fabric-based/coated conveyor belts</p> <ul style="list-style-type: none"> • Abrasion- and temperature-resistant coatings • Dedicated fabric construction e.g. frayless and non-fray • Specific coatings for improved release and oil/fat resistance 	<ul style="list-style-type: none"> → Reliable performance and long belt service life → Reduced risk of product contamination → Increased production output and waste reduction → Improved hygiene conditions
	<p>HabasitLINK® plastic modular belts</p> <ul style="list-style-type: none"> • Robust design and dedicated surfaces for conveying of bakery goods • Broad selection of materials 	<ul style="list-style-type: none"> → Reliable product handling and conveying → Good release and yield increase → Belts for elevated temperature, proofing, cooling, freezing and for spiral systems
	<p>Habasit Cleandrive™ combines</p> <ul style="list-style-type: none"> • Closed homogeneous surface • Continuous drive bars over entire belt width • Longitudinal reinforcement • Abrasion- and hydrolysis-resistant TPU 	<ul style="list-style-type: none"> → Innovative combination of homogeneous surface and positive drive → No gaps or hinges → Easy to clean → No creep, dimensional stability → Reliable sprocket engagement → Excellent chemical resistance
	<p>HabaSYNC® timing belts with</p> <ul style="list-style-type: none"> • Improved design and materials for wet and humid applications • Ability to apply special coatings 	<ul style="list-style-type: none"> → Precise positioning and conveying of goods → Easy to clean surfaces → Excellent chemical resistance → Various surface finishes for specific tasks in application
	<p>HabaCHAIN® plastic chains</p> <ul style="list-style-type: none"> • Various belt styles for radius and straight conveying • Wear-resistant and low-noise/low-friction materials 	<ul style="list-style-type: none"> → Positive drive and low tension → Reliable and versatile conveying of packed goods or trays/pans
	<p>HyCLEAN CIP system</p> <ul style="list-style-type: none"> • Works with low water pressure • Outside spray tube • Idle spray bar with nozzles • Edge cleaning nozzles 	<ul style="list-style-type: none"> → Fast and efficient cleaning and reduced water consumption → Cleans entire belt conveying side → Cleans hinge area and reverse side, exactly when hinges are most open → Cleans the belt edges and especially the rod head and retention system

Comprehensive services are central to Habasit's belting solution approach.

As committed partners to our customers, we are dedicated to sharing our knowledge and to providing full support.



Comprehensive consulting and technical support

Habasit offers the best consulting and technical support on the belting market. Everything revolves around our customers and each affiliate has its own belting experts. The Habasit team is proud to provide the highest levels of support together with top-quality products that have been leaders on the global market for decades.

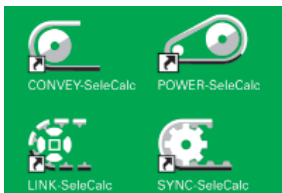

Assistance with belt selection and calculation

We will select and calculate the most suitable belt for your specific application. You also may do this yourself with our state-of-the-art Habasit selection and calculation program "SeleCalc". To order this program free of charge, simply call your nearest Habasit partner or contact: info@habasit.com.



Fabrication, assembly and local installation services for quick reaction times

We make belts endless or assemble modular belts or chains, either at our own locations or on-site directly on your machine or system. Habasit operates over 30 affiliated companies worldwide, each with its own inventory, fabrication, assembly and service facilities. Together with our representative offices and numerous qualified distributors, we can react quickly, competently and reliably to satisfy all your demands.



Customer training programs

Habasit offers training programs and provides support tools to ensure optimal use of our products and to prolong their lifetimes. Training on fabrication, installation, assembly, maintenance and belt repair takes place at Habasit sites or at your location.



Belt monitoring, inspections, analyses and process optimization proposals

We organize and handle belt maintenance, inspections, analyses and surveys for your locations. On request we will also work with you to develop optimization proposals, for example, to achieve added value from the machinery or process output.



Design assistance for customized solutions

Habasit believes in partnership. Our engineering team will work closely with your engineers on joint design developments, preferably from a very early stage. We particularly recommend this for projects involving new technologies or large-scale modifications and adaptations.



Customers first

At Habasit we understand that our success depends on your success. This is why we offer solutions, not just products; partnership, not just sales. Since our foundation in 1946, Habasit has brought this understanding of customer needs to life every day and for every application. That's why we're the No. 1 in belting today. Worldwide. Learn more on www.habasit.com

Committed to innovation

Habasit is strongly committed to the continuous development of innovative, value-added solutions. Over 3% of our staff are dedicated exclusively to R&D, and our annual investment in this area exceeds 8% of turnover.

Certified for quality

We deliver the highest quality standards not only in our products and solutions, but also in our employees' daily work processes. Habasit AG is certified according to ISO 9001:2000.



Worldwide leading product range

Habasit offers the largest selection of belting, conveying, processing and complementary products in the industry. Our response to any request is nothing less than a specific, tailor-made solution.

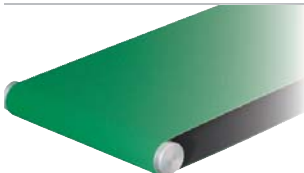

Fabric based conveyor and processing belts
HabaFLOW®

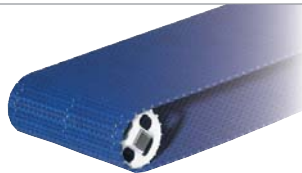

Plastic modular belts
HabasitLINK®

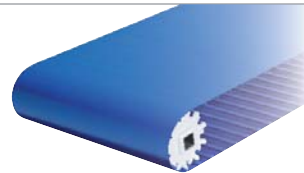

Positive drive conveyor and processing belts
Habasit Cleandrive™

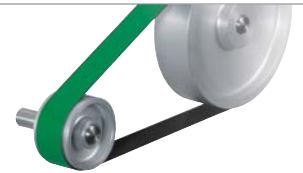

Power transmission belts
HabaDRIVE®



Timing belts
HabaSYNC®



Chains (slat and conveyor chains)
HabaCHAIN®

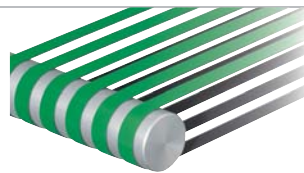

Machine tapes

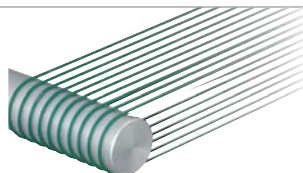

Round belts



Seamless belts

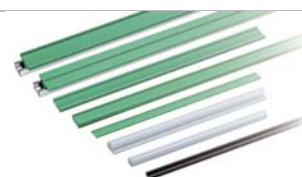

Profiles, Guides, Wear strips
HabiPLAST®



Fabrication tools (joining tools)



Gearmotors
Electric motors
Motion control

Austria

Habasit GmbH, Wien
Phone: +43 1 690 66
www.habasit.at

Belgium

Habasit Belgium N.V., Zaventem
Phone: +32 27 250 430
www.habasit.be

Canada

Habasit Canada Ltd., Oakville
Phone: +1 905 827 41 31
www.habasit.ca

China

Habasit East Asia Ltd., Hong Kong
Phone: +85 221 450 150
www.habasit.com.hk

Habasit (Shanghai) Co., Ltd.
Shanghai

Phone: +8621 5488 1228
Phone: +8621 5488 1218
www.habasit.com.hk

France

Habasit France S.A.S., Mulhouse
Phone: +33 389 338 903
www.habasit.fr

Germany

Habasit GmbH
Eppertshausen
Phone: +49 6071 969 0
www.habasit.de

India

Habasit-lakoka Pvt. Ltd., Coimbatore
Phone: +91 422 262 78 79
www.habasitlakoka.com

Italy

Habasit Italiana SpA
Customer Care:
Phone: 199 199 333
For int. calls: +39 0438 911 444
www.habasit.it

Japan

Habasit Nippon Co. Ltd., Yokohama
Phone: +81 454 760 371
www.habasit.co.jp

Netherlands

Habasit Netherlands BV, Nijkerk
Phone: +31 332 472 030
www.habasit.nl

New Zealand

Habasit Australasia Ltd., Hornby
Phone: +64 3348 5600
www.habasit.co.nz

Norway

Habasit Norge A/S, Oslo
Phone: +47 815 58 458
www.habasit.no

Poland

Habasit Polska Sp. zo.o.,
Dąbrowa Górnicza,
Phone: +48 32639 02 40
www.habasit.pl

Russia

OOO Habasit Ltd., St. Petersburg
Phone: +7 812 600 40 80
www.habasit.ru

Singapore

Habasit Far East Pte. Ltd., Singapore
Phone: +65 686 255 66
www.habasit.com.sg

Spain

Habasit Hispanica S.A.,
Barberà del Vallès
Phone: +34 937 191 912
www.habasit.es

Sweden

Habasit AB, Hindas
Phone: +46 30 122 600
www.habasit.se

Switzerland

Habasit GmbH, Reinach
Phone: +41 61 577 51 00
www.habasit.ch

Taiwan

Habasit Rossi (Taiwan) Ltd.
Taipei Hsien
Phone: +886 2 2267 0538
www.habasit.com.tw

Turkey

Habasit Kayis San. Ve Tic. Ltd. Sti.
Yenibosna - Bahcelievler - Istanbul
Phone: +90 212 654 94 04
www.habasit.com.tr

Ukraine

Habasit Ukraina, Vinnica
Phone: +38 0432 58 47 35
www.habasit.ua

United Kingdom and Ireland

Habasit Rossi (UK) Ltd., Silsden
Phone: +44 844 835 9555
www.habasitrossi.co.uk

USA

Habasit America
Conveyor belts, power
transmission belts, gearmotors
Suwanee, Georgia
Phone: +1 800 458 6431
www.habasitamerica.com

Habasit America
Seamless belts, timing belts
Middletown, Connecticut
Phone: +1 860 632 2211
www.habasitamerica.com

Rossi is one of Europe's largest manufacturers of gear reducers, gearmotors, inverters, standard and brakemotors, and is a member of the Habasit Group.

Rossi S.p.A.
Via Emilia Ovest 915/A
41123 Modena – Italy
Phone: +39 059 33 02 88
www.rossi-group.com
info@rossi-group.com

Headquarters

Habasit AG
CH-4153 Reinach-Basel
Phone +41 61 715 15 15
Fax +41 61 715 15 55
E-mail info@habasit.com
www.habasit.com

Copyright Habasit AG
Subject to alterations
Printed in Switzerland
Publication data:
2005BRO.FOD-en0912HOR